

A23

3MP Box with D/N, Extreme WDR, SLLS, Vari-focal Lens



- 3 Megapixel
- Day & Night with Superior Low Light Sensitivity
- Vari-focal Lens with f2.8-12mm/F1.4-F2.8, P-Iris
- Extreme WDR
- H.265 Compression
- Wide Angle
- Event trigger, response and notification

► Specifications

Device

Product Type	Box
Maximum Resolution	3MP
Application Environment	Indoor/Outdoor
Image Sensor	Progressive Scan CMOS
Sensor Size	1/2.8 "
Effective Pixels	2065(H) X 1553(V)
Day / Night	Yes
Low Light Sensitivity	Superior
Minimum Illumination	Color: 0.05 lux at F1.4; B/W 0.005 lux at F1.4 (AGC on)
Color to B/W Switch	ISP based switch, configurable
Mechanical IR Cut Filter	Yes
IR Sensitivity Range	700-1150nm
IR LED	No
Electronic Shutter	1/5-1/64000 second (manual mode); 1/5-1/64000 second (auto mode)
Horizontal Resolution (TV Lines)	1300 TVL
S/N Ratio	56 dB

Lens

Focal Length	Vari-focal, f2.8-12mm
Aperture	F1.4-F2.8
Iris	P-Iris
Focus	Auto back focus
Lens Mount	CS Mount (interchangeable lens)
Horizontal Viewing Angle	92.9° - 32.2°
Vertical Viewing Angle	68.2° - 25.0°

PTZ

Pan, Tilt or Zoom protocol	Pelco-D, Pelco-P, ACTi URL command
----------------------------	------------------------------------

Video

Compression	H.265, H.264 (Baseline/ Main/ High profile), MJPEG
Maximum Frame Rate vs. Resolution	30 fps at 2048 x 1536 30 fps at 1920 x 1080 30 fps at 1280 x 960 30 fps at 1280 x 720 30 fps at 800 x 600 30 fps at 720 x 480 30 fps at 640 x 480 30 fps at 320 x 240
Multi-Streaming	Simultaneous dual streams based on two configurations
Bit Rate	28Kbps - 12Mbps (per stream)
Bit Rate Mode	Constant, Variable
Wide Dynamic Range	Extreme WDR (142 dB)
Image Enhancement	White Balance, Brightness, Contrast, Sharpness, Automatic gain control, Flickerless, Digital Image Stabilizer (DIS, EIS), Defogging
Digital Noise Reduction	2D + 3D DNR
Privacy Mask	4 configurable regions
Text Overlay	Yes
On-Screen Graphics	Yes
Built-in Analytics	Tampering Detection
Server-based Analytics	Object Line Counting, People Counting, Face Detection, Object Based Motion Detection, Tamper, Object Line Crossing Detection, Object Enter Area Detection, Missing Object Detection, Unattended Object Detection, Smoke Detection, Heat Map, Dwell Time, People Queue Detection, (Require PC-based or standalone IVS or ALPR Server. Contact ACTi support for recommendations on how to maximize analytical accuracy)
Image Orientation	Flip, Mirror, Rotation

Audio

Audio Type	2-way, Built-in Microphone, Mic-in, Line-in, Line-out
Audio Compression	8 kHz, Mono, G.711

Network

Network Protocol & Service	IPv4/v6, TCP, UDP, DHCP, PPPoE, HTTP, HTTPS, DNS, DDNS, NTP, RTP, RTSP, RTCP, SMTP, FTP, IGMP, ICMP, ARP, Bonjour, UPnP, QoS, SNMP, IEEE 802.1X
Ethernet Port	1 x RJ-45 connector
Security	IP address filtering, HTTPS encryption, Password protected user level, Anonymous login

Event

Event Trigger	Video motion detection (3 regions), External device through digital input, Sound detection, Tampering detection
Event Response	Notify control center, Change camera settings, Command other devices, E-mail notification with snapshots, Save video to local storage, Upload video or snapshot to FTP server, Activate external device through digital output

Integration

Unified Solution	Fully compatible with ACTi software
GPS Position	Manual setting
ONVIF Compliant	Yes, Profile S, Profile G, Profile T, Profile Q
Web Browser	IE 11

Interface

Serial Port	1 x RS-485
Audio Interface	Built-in microphone, 1/1, Terminal block
Analog Video Output	1 x CVBS, BNC connector
Local Storage	MicroSDHC, MicroSDXC Memory Card Slot (card not included, up to 128GB)
Digital Input/Output	1/1 (Terminal block)

General

Power Source	DC 12V, PoE Class 3 (IEEE802.3af)
Power Consumption	9 W (PoE), 7 W (DC)
Weight	419g (0.924lb)
Dimensions	(W x H x D): 62mm x 58mm x 141.1mm (2.44" x 2.28" x 5.56")
Environmental Casing	Optional housing (IP66-IP68)
Mount Type	Wall Mount, Ceiling Bracket, Corner Mount, Pole Mount
Starting Temperature	-10°C ~ 50°C (14°F ~ 122°F)
Operating Temperature	-10°C ~ 50°C (14°F ~ 122°F)
Operating Humidity	10% - 90% RH
Approvals	CE, FCC, BSMI
Warranty	3 Year(s). For extended warranty offering, see http://www.acti.com/support/warranty

► Photo Indication



- 1 Input and Output Connector
 - DC 12V Power Input
 - Audio Input / Output
 - Digital Input/Output
 - Serial Port
- 2 Ethernet Port
- 3 Memory Card Slot
- 4 Reset Button

► Dimension Diagram

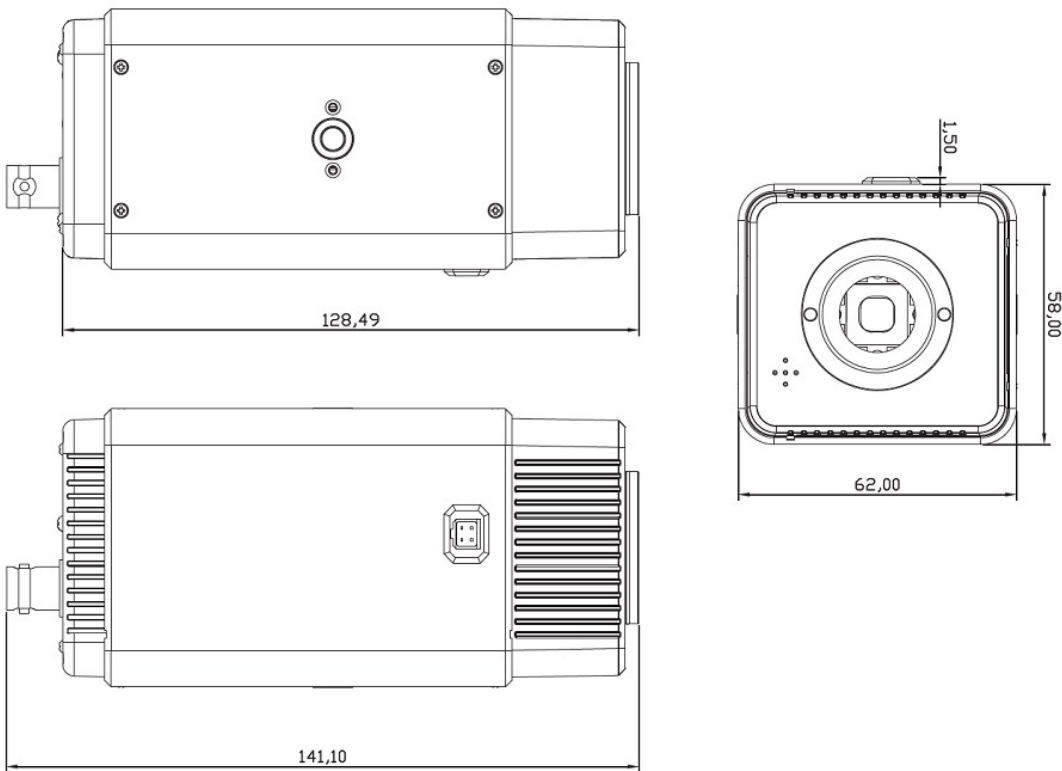



Unit: mm [inch]

► Ordering Information

A23-K1	3MP Bullet with D/N, Standard IR, Extreme WDR, SLLS, Vari-focal lens, f2.8-12mm/F1.4-2.8 (HOV:92.9°-32.2°), P-Iris, Auto Back Focus, H.265/H.264, 1080p/30fps, 2D+3D DNR, Built-in Microphone, MicroSDHC/MicroSDXC, IP68, DI/DO, RS-485
A23-K2	3MP Bullet with D/N, Standard IR, Extreme WDR, SLLS, Vari-focal lens, f2.8-12mm/F1.4-2.8 (HOV:92.9°-32.2°), P-Iris, Auto Back Focus, H.265/H.264, 1080p/30fps, 2D+3D DNR, Built-in Microphone, MicroSDHC/MicroSDXC, IP68, DI/DO, RS-485
A23-K3	3MP Bullet with D/N, Extreme IR, Extreme WDR, SLLS, Vari-focal lens, , , , H.265/H.264, 1080p/30fps, 2D+3D DNR, Built-in Microphone, MicroSDHC/MicroSDXC, IP68, DI/DO, RS-485
A23-K4	3MP Bullet with D/N, Extreme IR, Extreme WDR, SLLS, Vari-focal lens, , , , H.265/H.264, 1080p/30fps, 2D+3D DNR, Built-in Microphone, MicroSDHC/MicroSDXC, IP68, DI/DO, RS-485



► Related Products

Mounting Accessories - Camera Mount



PMAX-0402	 Corner Mount
PMAX-0503	 Pole Mount (for PMAX-0102, PMAX-0312, PMAX-0313, PMAX-0314, PMAX-0702, PMAX-1106, PMAX-1107), supports 5.25" to 8.5" Poles
PMAX-1106	 Bracket for Outdoor Box Cameras (KCM-5211E, KCM-5511, KCM-5611, Box Cameras with Outdoor Housing)

Note: Some mounting accessories may need additional accessories for installation. Please check www.acti.com/mountingselector for more information.

Enclosures - Box Camera Housing

PMAX-0200	 Outdoor Housing with Heater and Fan (110V)
PMAX-0201	 Outdoor Housing with Heater and Fan (220V)
PMAX-0202	 Outdoor Housing
PMAX-0208	 Explosion Proof Housing with Heater, Fan (AC 110V~220V) and Bracket
PMAX-0210	 Stainless Steel Housing with Heater, Fan (AC 110V~220V) and Bracket

Lenses - Vari-focal Lens

PLEN-2206	 Vari-focal f2.8-8.5mm, P Iris F1.2, Manual Focus, D/N, Megapixel, CS Mount Lens
PLEN-2209	 Vari-focal f5-50mm, DC Iris F1.4, Manual Focus, D/N, Megapixel, CS Mount Lens

Power Supply Accessories - PoE Injector

PPOE-0001  PoE Injector IEEE 802.3af compliant, AC 100~240V, with universal connectors

Network & Storage Peripherals - Data Switch

PPSW-0100  PLANET FGSD-910HP 8-Port 802.3at PoE Switch (PoE Budget 120W)

PPSW-0101  PLANET GS-4210-8P2T2S 8-Port Gigabit 802.3at Managed PoE Switch (PoE Budget 240W)

PPSW-0102  PLANET FGSD-1011HP 8-Port 802.3at PoE Switch (PoE Budget 120W)

PPSW-1101  PLANET GS-4210-24PL4C 24-Port Gigabit 802.3at Managed PoE Switch (PoE Budget 440W)

PPSW-2101  4-Port 802.3at PoE Switch (PoE Budget 62W)

PPSW-3100  PLANET FGSW-1816HPS 16-Port 802.3at PoE Switch (PoE Budget 220W)

Audio Devices - Microphone

PMIC-0100  Active Microphone Omnidirectional for all Cameras with Line-in Audio

PMIC-0201  Passive Microphone Omnidirectional for all Cameras with Mic-In Audio using Cable Wire or Terminal Connector, 2m cable

Illuminators - IR LED Illuminator

PLED-0200  SPINLUX (SL-A2IRXX10-24CL) IR Illuminator 10° Angle with 120 m approx. range

PLED-0201  SPINLUX (SL-A2IRXX25-24CL) IR Illuminator 25° Angle with 50 m approx. range

PLED-0202  SPINLUX (SL-A2IRXX35-24CL) IR Illuminator 35° Angle with 25 m approx. range

PLED-0204  SPINLUX (SL-A2IRXX25-48CL) IR Illuminator 25° Angle with 80 m approx. range

PLED-0205  SPINLUX (SL-A2IRXX35-48CL) IR Illuminator 35° Angle with 40 m approx. range

Installation Support - Camera Installation Kit

PMON-2000  Camera Installation Kit