

A425

2MP Face, People and Car Detection Zoom Bullet with D/N, Adaptive IR, Extreme WDR, ELLS, 4.3x Zoom Lens



- Face, People and Car Detection
- 2 Megapixel (Support 120fps@1080P)
- Day & Night with Extreme Low Light Sensitivity and Adaptive IR LED
- 4.3x Zoom Lens with f2.8-12/F1.8-F3.3, Auto focus (for installation)
- Extreme WDR
- Super wide angle
- Event trigger, response and notification

► Specifications

Device

Product Type	Zoom Bullet
Maximum Resolution	2MP
Product Application	Face, People and Car Detection
Application Environment	Outdoor
Image Sensor	Progressive Scan CMOS
Sensor Size	1/2.8 "
Effective Pixels	1945(H) X 1097(V) (2.13 MP)
Day / Night	Yes
Low Light Sensitivity	Extreme
Minimum Illumination	Color: 0.002 lux (30 IRE); B/W: 0 lux (IR LED on)
Mechanical IR Cut Filter	Yes
IR LED	Adaptive IR LED
IR Working Distance	50m
Electronic Shutter	1/5-1/64000 second (manual mode); 1/5-1/64000 second (auto mode)
Horizontal Resolution (TV Lines)	1000 TVL

S/N Ratio	75 dB
-----------	-------

Lens

Focal Length	Zoom, f2.8-12mm
Aperture	F1.8-F3.3
Zoom Ratio	4.3x optical zoom
Zoom Application	Camera Installation
Iris	Adaptive iris
Focus	Auto focus
Lens Mount	Board mount
Horizontal Viewing Angle	106.6° - 34.6°
Vertical Viewing Angle	54.4° - 19.5°

Video

Compression	H.265, H.264 (Main profile), MJPEG
Maximum Frame Rate vs. Resolution	120 fps at 1920 x 1080 (High Frame Mode) 60 fps at 1920 x 1080 (High Frame Mode) 30 fps at 1920 x 1080 30 fps at 1280 x 960 120 fps at 1280 x 720 (High Frame Mode) 60 fps at 1280 x 720 (High Frame Mode) 30 fps at 1280 x 720 30 fps at 800 x 600 30 fps at 720 x 480 30 fps at 640 x 480
High Frame Mode	Support
Multi-Streaming	Simultaneous triple streams based on configurations of video resolution, compression format, and frame rate
Bit Rate Mode	Constant, Variable
Wide Dynamic Range	Extreme WDR (142 dB)
Image Enhancement	White Balance, Brightness, Contrast, Saturation, Sharpness, Backlight compensation (BLC), Strong Light Suppression, Digital Image Stabilizer (DIS, EIS)
Digital Noise Reduction	2D + 3D DNR
Privacy Mask	4 configurable regions
Text Overlay	Yes
On-Screen Graphics (Picture Overlay)	Yes
Built-in Analytics	Deep Learning : Face Detection, People Detection, Vehicle Detection, Tampering Detection, People Line Crossing Detection, People Enter Area Detection, People Exit Area Detection, People Loitering Detection
Image Orientation	Flip, Mirror, Rotation (Corridor mode) (90°, 180°, 270°)

Audio

Audio Type	2-way, Mic-in, Line-in, Line-out
Audio Compression	8 kHz, Mono, G.711

Network

Network Protocol & Service	IPv4/v6, TCP, UDP, DHCP, PPPoE, HTTP, HTTPS, DNS, DDNS, NTP, RTP, RTSP, RTCP, SMTP, FTP, IGMP, ICMP, ARP, Bonjour, UPnP, QoS, SNMP, IEEE 802.1X
Ethernet Port	1 x Ethernet (10/100 Base-T), RJ-45 pigtail connector

Security	IP address filtering, HTTPS encryption, Password protected user level, Anonymous login, IEEE 802.1X network access control
----------	--

Event

Event Trigger	Video motion detection (3 regions), External device through digital input, Sound detection, Intelligent event detection, Video streams loss
Event Response	Notify control center, Change camera settings, Command other devices, E-mail notification with snapshots, Play the audio file, Push notification to mobile device, Save video to local storage, Upload video to NVR server, Upload video or snapshot to FTP server, Activate external device through digital output

System

System Monitor	CPU loading, memory usage and network statistics via API
Watchdog	Support

Integration

Unified Solution	Fully compatible with ACTi software
GPS Position	Manual setting
Edge Recording	Support (integration with NVR by ONVIF Profile G or proprietary protocol)*
ONVIF Compliant	Yes, Profile S, Profile G, Profile Q, Profile T, Profile M
Web Browser	IE 11, Google Chrome, Microsoft Edge, Apple Safari
Auto Firmware Upgrade	Yes

Interface

Audio Interface	Cable with 3.5mm Phone Jack
Local Storage	MicroSD, MicroSDHC, MicroSDXC Memory Card Slot (card not included, up to 256GB, Kingston or Sandisk only)
Digital Input/Output	1/1 (Terminal block)
Operating Button	Reset Button

General

Power Source	DC 12V, PoE Class 3 (IEEE802.3af)
Weight	1240g (2.73lb)
Dimensions	(W x H x D): 94mm x 86mm x 291.1mm (3.7" x 3.38" x 11.46")
Environmental Casing	Weatherproof (IP67), Vandal proof metal casing (IK10)
Corrosion Protection	Optional for project request. Chassis corrosion resistance at the seashore approximately 2-3 years.
Bundled Accessories	Integrated bracket
Mount Type	Integrated Bracket, Wall Mount, Ceiling Bracket, Pole Mount
Operating Temperature	-30°C ~ 50°C (-22°F ~ 122°F)
Approvals	CE Class A, FCC Class A, IP67, IK10 (metal casing)
Color	White
Real-time Clock (RTC)	Yes
Warranty	3 Year(s). For extended warranty offering, see http://www.acti.com/support/warranty

* Edge Recording function is integrated with NVR 3 Corporate / NVR 3 Business / INR / GNR series.

► Photo Indication



- 1 Audio Output
- 2 DC 12V Power Input
- 3 Reset Button
- 4 Audio Input
- 5 Ethernet Port
- 6 Digital Input / Output



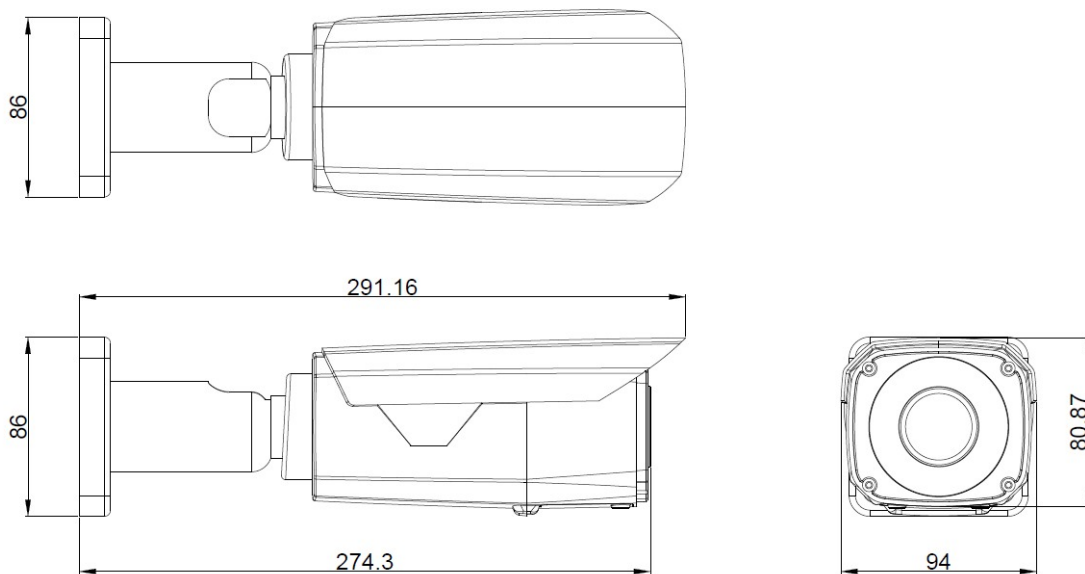

► Dimension Diagram



Unit: mm [inch]

▶ Related Products

Mounting Accessories - Camera Mount



PMAX-0512		Pole Mount (for E39, PMAX-0706), supports 3.25" to 7.0" Poles
PMAX-0517		Pole Mount (for A44, A45, A46, A48, A413), supports 3.25" to 7.0" Poles
PMAX-0518		Pole Mount (for A44, A45, A46, A48, A413), supports 2" to 3" Poles
PMAX-0524		Pole Mount (for A416, A418, A419, A44, A45, A46, A48, VMGB-351, B419-P2), supports 2.64" to 5" Poles
PMAX-0706		Junction Box (for A3x, A4x, E39, E41x, PMAX-0805)

Note: Some mounting accessories may need additional accessories for installation. Please check www.acti.com/mountingselector for more information.

Power Supply Accessories - Power Adapter

PPBX-0012		Power Adapter AC 100~240V (US), for A3x, A4x, A88, A9x, Z31, Z8x, Z9x
PPBX-0013		Power Adapter AC 100~240V (EU), for A3x, A4x, A88, A9x, Z31, Z8x, Z9x
PPBX-0014		Power Adapter AC 100~240V (UK), for A3x, A4x, A88, A9x, Z31, Z8x, Z9x
PPBX-0026		Power Adapter AC 100~240V (US) for A3x, A4x, A7x, A88, A9x, Z3x, Z4x, Z7x, Z8x, Z9x

Audio Devices - Microphone

PMIC-0100		Active Microphone Omnidirectional for all Cameras with Line-in Audio
PMIC-0200		Passive Microphone Omnidirectional for all Cameras with Mic-in Audio using 3.5mm Phone Jack