

# A42

## 5MP Zoom Bullet with D/N, Adaptive IR, Extreme WDR, SLLS, 2.8x Zoom Lens



- 5 Megapixel
- Day & Night with Superior Low Light Sensitivity and Adaptive IR LED
- 2.8x Zoom Lens with f3.6-10mm/F1.5-F2.8, P-Iris, Auto focus (for installation)
- Extreme WDR
- H.265 Compression
- Event trigger, response and notification

### ► Specifications

#### Device

Product Type	Zoom Bullet
Maximum Resolution	5MP
Application Environment	Outdoor
Image Sensor	Progressive Scan CMOS
Sensor Size	1/1.8 "
Effective Pixels	3096(H) X 2080(V) (6.44 MP)
Day / Night	Yes
Low Light Sensitivity	Superior
Minimum Illumination	Color: 0.1 lux at F1.5; B/W 0.05 lux at F1.5 (AGC on)
Color to B/W Switch	ISP based switch, configurable
Mechanical IR Cut Filter	Yes
IR Sensitivity Range	700-1150nm
IR LED	Adaptive IR LED x 22 (850 nm)
IR Working Distance	30m
Electronic Shutter	1/5-1/64000 second (manual mode); 1/5-1/64000 second (auto mode)
Horizontal Resolution (TV Lines)	1650 TVL

S/N Ratio	56 dB
-----------	-------

**Lens**

Focal Length	Zoom, f3.6-10mm
Aperture	F1.5-F2.8
Zoom Ratio	2.8x optical
Zoom Application	Camera Installation
Iris	P-Iris
Focus	Auto focus
Lens Mount	Board mount
Horizontal Viewing Angle	79.5° - 38.1°
Vertical Viewing Angle	59.6° - 27.8°

**PTZ**

Pan, Tilt or Zoom protocol	Pelco-D, Pelco-P, ACTi URL command
----------------------------	------------------------------------

**Video**

Compression	H.265, H.264 (Baseline/ Main/ High profile), MJPEG
Maximum Frame Rate vs. Resolution	30 fps at 2592 x 1944 30 fps at 2048 x 1536 60 fps at 1920 x 1080 30 fps at 1280 x 960 60 fps at 1280 x 720 30 fps at 800 x 600 30 fps at 720 x 480 30 fps at 640 x 480 30 fps at 320 x 240
Multi-Streaming	Simultaneous triple streams based on three configurations
Bit Rate	128Kbps - 20Mbps (per stream)
Bit Rate Mode	Constant, Variable
Wide Dynamic Range	Extreme WDR (122 dB)
Image Enhancement	White Balance, Brightness, Contrast, Sharpness, Automatic gain control, Flickerless, Digital Image Stabilizer (DIS, EIS), Defogging
Digital Noise Reduction	2D + 3D DNR
Privacy Mask	4 configurable regions
Text Overlay	Yes
On-Screen Graphics	Yes
Built-in Analytics	Tampering Detection
Server-based Analytics	Object Line Counting, People Counting, Face Detection, Object Based Motion Detection, Tamper, Object Line Crossing Detection, Object Enter Area Detection, Missing Object Detection, Unattended Object Detection, Smoke Detection, Heat Map, Dwell Time, Direction Detection, Automatic License Plate Recognition, People Queue Detection, (Require PC-based or standalone IVS or ALPR Server. Contact ACTi support for recommendations on how to maximize analytical accuracy)
Image Orientation	Mirror, Flip, Rotation

**Audio**

Audio Type	2-way, Mic-in, Line-in, Line-out
Audio Compression	8 kHz, Mono, G.711

**Network**

Network Protocol & Service	IPv4/v6, TCP, UDP, DHCP, PPPoE, HTTP, HTTPS, DNS, DDNS, NTP, RTP, RTSP, RTCP, SMTP, FTP, IGMP, ICMP, ARP, Bonjour, UPnP, QoS, SNMP
----------------------------	--

Ethernet Port	1 x Ethernet (10/100 Base-T), RJ-45 pigtail connector
Security	IP address filtering, HTTPS encryption, Password protected user level, Anonymous login

**Event**

Event Trigger	Video motion detection (3 regions), External device through digital input, Sound detection, Tampering detection
Event Response	Notify control center, Change camera settings, Command other devices, E-mail notification with snapshots, Upload video or snapshot to FTP server, Activate external device through digital output

**Integration**

Unified Solution	Fully compatible with ACTi software
GPS Position	Manual setting
ONVIF Compliant	Yes, Profile S, Profile T, Profile Q
Web Browser	IE 11

**Interface**

Audio Interface	3.5mm Phone Jack
Analog Video Output	1 x CVBS, BNC connector
Digital Input/Output	1/1 (Cable with Terminal block)

**General**

Power Source	DC 12V (adapter not included), PoE Class 3 (IEEE802.3af)
Power Consumption	10 W (PoE, IR on), 8 W (DC, IR on)
Weight	812.5g (1.791lb)
Dimensions	(Ø x L): 80.0mm x 258.30mm (3.149" x 10.169")
Environmental Casing	Weatherproof (IP66), Vandal proof metal casing (IK10)
Bundled Accessories	Integrated bracket
Mount Type	Integrated Bracket, Pole Mount
Starting Temperature	-20°C ~ 50°C (-4°F ~ 122°F)
Operating Temperature	-30°C ~ 50°C (-22°F ~ 122°F)
Operating Humidity	20% - 80% RH
Approvals	CE Class A, FCC Class A, IP66, NEMA 4X, IK10 (metal casing)
Warranty	3 Year(s). For extended warranty offering, see <a href="http://www.acti.com/support/warranty">http://www.acti.com/support/warranty</a>

### ► Photo Indication



- 1 Audio Output
- 2 DC 12V Power Input
- 3 Factory Reset
- 4 BNC Video Output
- 5 Audio Input
- 6 Ethernet Port
- 7 Digital Input/Output

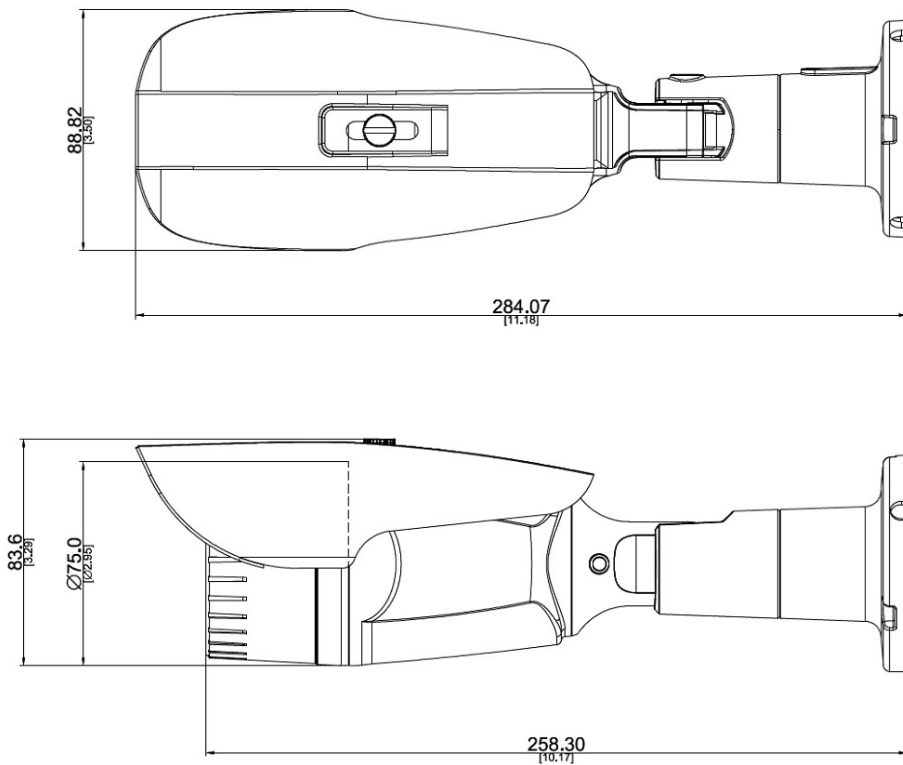

### ► Dimension Diagram



Unit: mm [inch]

## ▶ Related Products

### Mounting Accessories - Camera Mount

PMAX-0506		Pole Mount (for A31, A4x, E78, E9x, E9xx), supports 2" to 3" Poles
PMAX-0508		Pole Mount (for PMAX-0203, PMAX-0204, PMAX-0205, PMAX-0206, PMAX-0704), supports 3" to 9" Poles
PMAX-0704		Junction Box (for A4x, B4x, B41x, E44, E45, E46, E48, E44A, E45A, E46A, E41x, I4x, PMAX-0203~PMAX-0205)
PMAX-0706		Junction Box (for A3x, A4x, E39, E41x, PMAX-0805)

**Note:** Some mounting accessories may need additional accessories for installation. Please check [www.acti.com/mountingselector](http://www.acti.com/mountingselector) for more information.

### Bullet Covers - Front Cover

R700-00011		Front Cover (for A42 )
------------	---	------------------------



### Power Supply Accessories - Power Adapter

PPBX-0012		Power Adapter AC 100~240V (US), for A3x, A4x, A88, A9x, Z31, Z8x, Z9x
PPBX-0013		Power Adapter AC 100~240V (EU), for A3x, A4x, A88, A9x, Z31, Z8x, Z9x
PPBX-0014		Power Adapter AC 100~240V (UK), for A3x, A4x, A88, A9x, Z31, Z8x, Z9x

### Power Supply Accessories - PoE Injector

PPOE-0001		PoE Injector IEEE 802.3af compliant, AC 100~240V, with universal connectors
-----------	---	---

### Network & Storage Peripherals - Data Switch

PPSW-0102		PLANET FGSD-1011HP 8-Port 802.3at PoE Switch (PoE Budget 120W)
PPSW-3100		PLANET FGSW-1816HPS 16-Port 802.3at PoE Switch (PoE Budget 220W)

### Extenders - PoE Extender

PPEX-0100		Veracity OUTREACH Max Power over Ethernet (PoE) Extender
-----------	---	--

### Extenders - PoE over Coaxial Extender Kit

PPOC-0100		Planet LRP-101C-KIT Power over Coax Adapter Kit
-----------	---	---

### Audio Devices - Microphone

PMIC-0100		Active Microphone Omnidirectional for all Cameras with Line-in Audio
-----------	---	--

PMIC-0200		Passive Microphone Omnidirectional for all Cameras with Mic-in Audio using 3.5mm Phone Jack
-----------	---	---

### Illuminators - IR LED Illuminator

PLED-0200		SPINLUX (SL-A2IRXX10-24CL) IR Illuminator 10° Angle with 120 m approx. range
-----------	---	--

PLED-0201		SPINLUX (SL-A2IRXX25-24CL) IR Illuminator 25° Angle with 50 m approx. range
-----------	---	---

PLED-0202		SPINLUX (SL-A2IRXX35-24CL) IR Illuminator 35° Angle with 25 m approx. range
-----------	---	---

PLED-0204		SPINLUX (SL-A2IRXX25-48CL) IR Illuminator 25° Angle with 80 m approx. range
-----------	---	---

PLED-0205		SPINLUX (SL-A2IRXX35-48CL) IR Illuminator 35° Angle with 40 m approx. range
-----------	---	---

### Installation Support - Camera Installation Kit

PMON-2000		Camera Installation Kit
-----------	---	-------------------------