

A713

5MP Outdoor Hemispheric Dome with D/N, Adaptive IR, Extreme WDR, SLLS, Fixed Lens



- 5 Megapixel
- Day & Night with Superior Low Light Sensitivity and Adaptive IR LED
- Fisheye Lens with f1.1mm/F2.4
- Extreme WDR
- H.265 Compression
- 360°/180° Panorama View with Dewarped Streaming
- Event trigger, response and notification

► Specifications

Device

Product Type	Hemispheric Dome
Maximum Resolution	5MP
Application Environment	Outdoor
Image Sensor	Progressive Scan CMOS
Sensor Size	1/3.2 "
Effective Pixels	2592(H) X 1944(V) (5.04 MP)
Day / Night	Yes
Low Light Sensitivity	Superior
Minimum Illumination	Color: 0.01 lux at F2.4; B/W: 0 lux (IR LED on)
Color to B/W Switch	ISP based switch, configurable
Mechanical IR Cut Filter	Yes
IR Sensitivity Range	700-1100nm
IR LED	Adaptive IR LED
IR Working Distance	20m
Electronic Shutter	1-1/10000 second (manual mode); 1-1/10000 second (auto mode)

Horizontal Resolution (TV Lines)	1800 TVL
S/N Ratio	56 dB

Lens

Focal Length	Fixed focal, f1.1mm
Aperture	F2.4
Iris	Fixed iris
Focus	Fixed focus
Lens Mount	Board mount
Horizontal Viewing Angle	197° (overview area)
Vertical Viewing Angle	197° (Fisheye View)

Video

Compression	H.265, H.264 (Main/ High profile), MJPEG
Maximum Frame Rate vs. Resolution	(Fisheye View) 30 fps at 2560 x 1960 30 fps at 1920 x 1920 30 fps at 1920 x 1080 30 fps at 1600 x 1200 30 fps at 1408 x 1408 30 fps at 960 x 960 30 fps at 960 x 720 30 fps at 960 x 544 (Dewarped View) 30 fps at 1920 x 1080 30 fps at 1600 x 1200 30 fps at 960 x 720 30 fps at 960 x 544 (ePTZ View) 30 fps at 1920 x 1920 30 fps at 1920 x 1080 30 fps at 1600 x 1200 30 fps at 1408 x 1408 30 fps at 960 x 960 30 fps at 960 x 720 30 fps at 960 x 544 30 fps at 480 x 360
View Mode	Fisheye View Dewarped View 270-degree Corner View Multiple View ePTZ View
Multi-Streaming	Simultaneous triple streams based on a single configuration
Bit Rate	128Kbps - 12Mbps (per stream)
Bit Rate Mode	Constant, Variable
Wide Dynamic Range	Extreme WDR (130 dB)
Image Enhancement	White Balance, Brightness, Contrast, Sharpness, Saturation, Automatic gain control, Backlight compensation (BLC)
Digital Noise Reduction	2D + 3D DNR
Privacy Mask	Yes, 5 configurable regions
Text Overlay	Yes
Built-in Analytics	Tampering Detection
Image Orientation	Flip, Mirror

Audio

Audio Type	2-way, Line-in, Line-out
Audio Compression	PCM, G.711, G.726, AAC

Network

Network Protocol & Service	IPv4/v6, TCP, UDP, PPPoE, HTTP, HTTPS, DDNS, NTP, RTP, RTSP, SMTP, FTP, ICMP, ARP, UPnP, QoS, SNMP, IEEE 802.1X
Ethernet Port	1 x Ethernet (10/100 Base-T), RJ-45 pigtail connector
Security	IP address filtering, HTTPS encryption, Password protected user level, IEEE 802.1X network access control

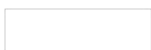

Event

Event Trigger	Video motion detection, Tampering detection, External device through digital input, Sound detection
Event Response	E-mail notification with snapshots, Save video to local storage, Upload snapshot to FTP server, Activate external device through digital output

System

System Log	Support
Watchdog	Support

Integration

Unified Solution	Fully compatible with ACTi software
Edge Recording	Support (integration with NVR by ONVIF Profile G)
ONVIF Compliant	Yes, Profile S, Profile G, Profile T, Profile M
Web Browser	Microsoft Edge(IE mode), Microsoft Edge, Google Chrome, Firefox

Interface

Audio Interface	1/1, Cable with 3.5mm Phone Jack
Local Storage	MicroSD, MicroSDHC, MicroSDXC Memory Card Slot (card not included, up to 256GB, Kingston or Sandisk only)
Digital Input/Output	1/1 (Terminal block)
Operating Button	Reset Button

General

Power Source	DC 12V, PoE Class 0 (IEEE802.3af)
Power Consumption	12.95 W (PoE)
Weight	557.5g (1.23lb)
Dimensions	(Ø x H): 130mm x 57.8mm (5.11" x 2.28")
Environmental Casing	Weatherproof (IP66), Vandal proof (IK10)
Corrosion Protection	Optional for project request. Chassis corrosion resistance at the seashore approximately 2-3 years.
Mount Type	Wall Mount, Pole Mount, Pendant, Corner Mount, Gang Box
Heater	Yes
Operating Temperature	-30°C ~55°C (-22°F ~ 131°F) heater on
Operating Humidity	10% - 90% RH
Approvals	CE Class A, FCC Class A, IP66, IK10
Real-time Clock (RTC)	Yes
Warranty	3 Year(s). For extended warranty offering, see http://www.acti.com/support/warranty

► Photo Indication

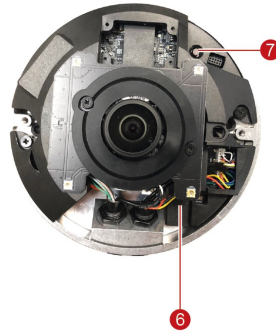

- 1 DC 12V Power Input
- 2 Ethernet Port
- 3 Audio Input
- 4 Digital Input / Output
- 5 Audio Output
- 6 Memory Card Slot
- 7 Reset Button



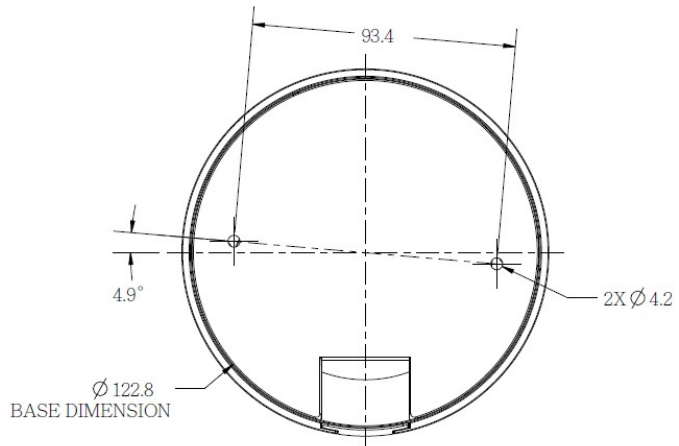
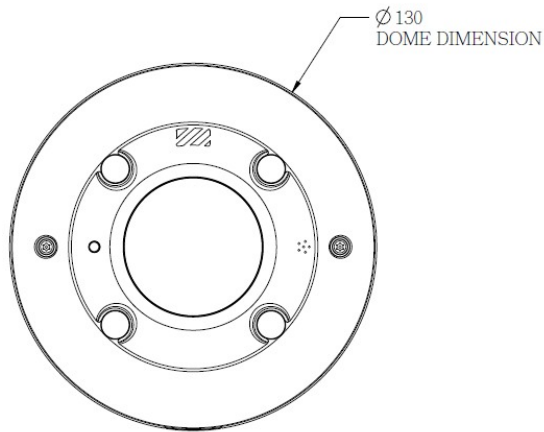
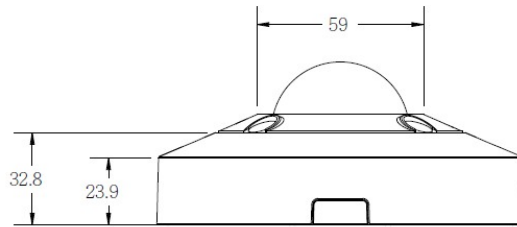
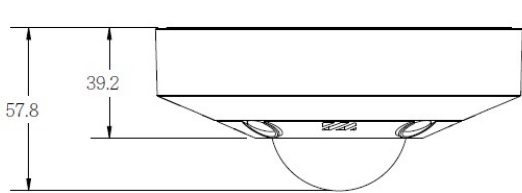









► Dimension Diagram



Unit: mm [inch]

▶ Related Products

Mounting Accessories - Camera Mount



PMAX-0102		Straight Tube
PMAX-0103		Straight Tube with Bracket
PMAX-0130		Mount Kit (for A711, A713)
PMAX-0302		Gooseneck with Bracket
PMAX-0303		Gooseneck
PMAX-0354		Heavy Duty Wall Mount for A711, A713
PMAX-0355		10-Degree Tilted Wall Mount (for A711, A713)
PMAX-0356		35-Degree Tilted Wall Mount (for A711, A713)
PMAX-0402		Corner Mount
PMAX-0503		Pole Mount (for PMA-0102, PMA-0312, PMA-0313, PMA-0314, PMA-0702, PMA-1106, PMA-1107), supports 5.25" to 8.5" Poles
PMAX-0702		Junction Box for PTZ and Dome Cameras
PMAX-0822		Gang Box Converter (for A711, A713)
PMAX-1033		Flush Mount (for A711, A713)

Note: Some mounting accessories may need additional accessories for installation. Please check www.acti.com/mountingselector for more information.

Power Supply Accessories - Power Adapter

PPBX-0011		Power Adapter AC 100~240V, with universal connectors for all DC12V powered devices
-----------	---	--

Network & Storage Peripherals - Memory Card

PMMC-0400		SanDisk 128GB MicroSDXC Class 10 Memory Card (SDSQQNR-128G-GN6IA)
PMMC-0500		Kingston 256GB MicroSDXC Class 10 UHS-1 Memory Card (SDCS2/256Gb)