

A71

4MP Outdoor Dome with D/N, IR, Extreme WDR, SLLS, Fixed Lens



- 4 Megapixel
- Day & Night with Superior Low Light Sensitivity and IR LED
- Fixed Lens with f2.8mm/F1.6
- Extreme WDR
- H.265 Compression
- Super wide angle
- Event trigger, response and notification

► Specifications

Device

Product Type	Dome
Maximum Resolution	4MP
Application Environment	Outdoor
Image Sensor	Progressive Scan CMOS
Sensor Size	1/2.7 "
Day / Night	Yes
Low Light Sensitivity	Superior
Minimum Illumination	Color: 0.018 lux; B/W: 0 lux (IR LED on)
Color to B/W Switch	ISP based switch, configurable
Mechanical IR Cut Filter	Yes
IR LED	IR LED (850 nm)
IR Working Distance	65m (1.0 lux)
Electronic Shutter	1/30-1/100000 second (auto mode)
S/N Ratio	75 dB

Lens	
Focal Length	Fixed focal, f2.8mm
Aperture	F1.6
Iris	Fixed iris
Focus	Fixed focus
Lens Mount	Board mount
Horizontal Viewing Angle	101.3°
Vertical Viewing Angle	55.3°
Viewing Angle Adjustment	Pan: 0°-355°, Tilt: 0°-75°, Rotation: 0°-355°

Video	
Compression	H.265, H.264 (Main/ High profile), MJPEG
Maximum Frame Rate vs. Resolution	30 fps at 2688 x 1520 30 fps at 2560 x 1440 30 fps at 1920 x 1080 30 fps at 1280 x 960 30 fps at 1280 x 720 30 fps at 640 x 480
Multi-Streaming	Simultaneous quad streams
Bit Rate	128Kbps - 12Mbps (per stream)
Bit Rate Mode	Constant, Variable
Wide Dynamic Range	Extreme WDR (150 dB)
Image Enhancement	White Balance, Backlight compensation (BLC), Brightness, Contrast, Sharpness, Automatic gain control
Digital Noise Reduction	2D + 3D DNR
Privacy Mask	4 configurable regions
Text Overlay	Yes
Built-in Analytics	Tampering Detection, Face Detection, Object Line Crossing Detection, Object Enter Area Detection
Server-based Analytics	Object Line Counting, People Counting, Face Detection, Object Based Motion Detection, Tamper, Object Line Crossing Detection, Object Enter Area Detection, Missing Object Detection, Unattended Object Detection, Smoke Detection, Heat Map, Dwell Time, Direction Detection, Automatic License Plate Recognition, People Queue Detection, (Require PC-based or standalone IVS or ALPR Server. Contact ACTi support for recommendations on how to maximize analytical accuracy)
Image Orientation	Flip, Mirror, Rotation (Corridor mode)

Audio	
Audio Type	2-way, Line-in, Mic-in, Line-out
Audio Compression	G.711

Network	
Network Protocol & Service	IPv4/v6, TCP, UDP, DHCP, PPPoE, HTTP, HTTPS, DNS, DDNS, NTP, RTP, RTSP, RTCP, SMTP, FTP, SFTP, IGMP, ICMP, Bonjour, UPnP, QoS, TLS 1.2, SNMP, IEEE 802.1X
Ethernet Port	1, Ethernet (10/100 Base-T), RJ-45 pigtail connector
Security	IP address filtering, HTTPS encryption, Password protected user level, Anonymous login, IEEE 802.1X network access control, Standard IoT Security (anti-hacking, anti-malware)

Event

Event Trigger	Video motion detection (10 included and excluded polygonal regions), External device through digital input, Intelligent event detection, Sound detection, Video streams loss, System log buffer overrun, Remove system log, Logon events (Login Failure, Login Success, Block an Account)
Event Response	Notify control center, Change camera settings, Command other devices, E-mail notification with snapshots, Play the audio file, Push notification to mobile device, Save video to local storage, Upload video to NVR server, Upload video or snapshot to FTP server, Activate external device through digital output

System

System Monitor	CPU loading, memory usage and network statistics via API
System Log	Support
Watchdog	Support

Integration

Unified Solution	Fully compatible with ACTi software
GPS Position	Manual setting
Edge Recording	Support (integration with NVR by ONVIF Profile G or proprietary protocol)**
ONVIF Compliant	Yes, Profile S, Profile G, Profile T, Profile M
GB28181 Compliant	Yes
Web Browser	IE 11, Google Chrome*, Microsoft Edge*, Apple Safari*
Auto Firmware Upgrade	Yes

Interface

Audio Interface	1/1, Terminal block
Local Storage	MicroSD, MicroSDHC, MicroSDXC Memory Card Slot (card not included, up to 256GB, Kingston or Sandisk only)
Digital Input/Output	1/1 (Terminal block)
Operating Button	Reset Button

General

Power Source	DC 12V, PoE Class 3 (IEEE802.3af)
Power Consumption	6 W (DC), 7.5 W (PoE)
Weight	534g (1.177lb)
Dimensions	(Ø x H): 110.82mm x 84.7mm (4.36" x 3.33")
Environmental Casing	Weatherproof (IP68), Vandal proof (IK10)
Operating Temperature	-30°C ~ 60°C (-22°F ~ 140°F)
Operating Humidity	10% - 95% RH
Approvals	CE Class B, FCC Class B, EAC, BIS, IP68, NEMA 4X, IK10, EN50121-3-2, EN50155
Real-time Clock (RTC)	Yes
Warranty	3 Year(s). For extended warranty offering, see http://www.acti.com/support/warranty

* cross-browser compatibility: Not available for H.265 video decoding ** Edge Recording function is integrated with NVR 3 Corporate / NVR 3 Business / INR / GNR series.

► Photo Indication

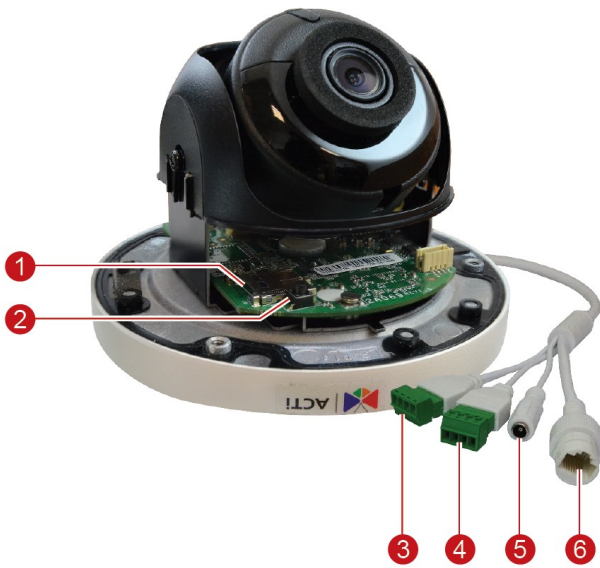

- 1 Memory Card Slot
- 2 Reset Button
- 3 Audio Input / Output
- 4 Digital Input / Output
- 5 DC12V Power Input Jack
- 6 Ethernet Port

► Dimension Diagram

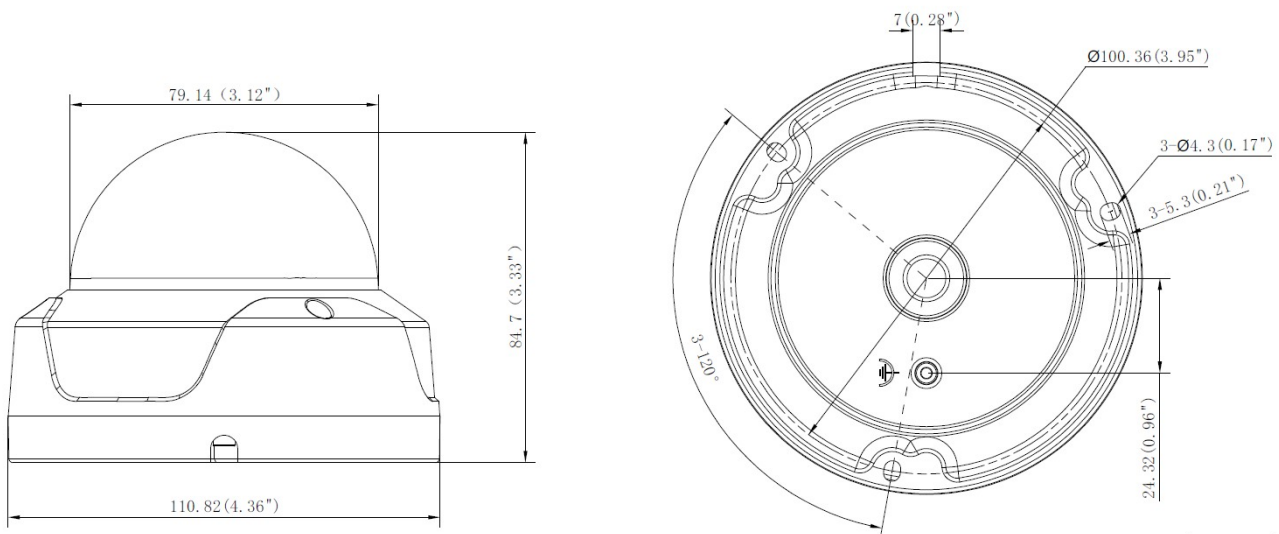













Unit: mm (inch)

Unit: mm [inch]

► Related Products

Mounting Accessories - Camera Mount

PMAX-0122		Straight Tube (for A71, A88, A9x,)
PMAX-0123		Extension Tube (for A71, A88, A9x,)
PMAX-0128		Pendant Mount (for Z85, Z86, Z87, Z810)
PMAX-0318		Wall Mount (for Z91, Z97, Z98, Z710, Z714, Z715, A71, A76, A77)
PMAX-0323		Wall Mount with Built-in Junction Box (for Z91, Z94, Z95,Z97,Z98, Z77, Z81, Z82, Z85, Z86, Z87, A7X)
PMAX-0506		Pole Mount (for A31, A4x, E78, E9x, E9xx), supports 2" to 3" Poles
PMAX-0527		Pole Mount (for Z4x, Z710, Z8x, Z9x, A7x), supports 2.64" to 5" Poles
PMAX-0532		Pole Mount (Z710, Z8x, Z9x, A7x), supports 2.6" to 5" Poles
PMAX-0718		Junction Box (for A71, A74, A77)
PMAX-0816		Converter Ring, 1.0" NPT for Third-Party Mounting Accessories, White
PMAX-0820		Gang Box Converter (for A71, A74, Z91, Z94, Z95), supports 4" Round and 4" Octagon Boxes
PMAX-1032		Flush Mount (for A71, A74, A77, E78, E79, E710)
PMAX-1402		Mount Kit (for Z91, Z97, Z98, Z710, Z714, Z715, A71, A76, A77)

Note: Some mounting accessories may need additional accessories for installation. Please check www.acti.com/mountingselector for more information.

Dome Covers - Transparent Dome Cover

R701-70012		Transparent Dome Cover for A71, A74.
------------	-------------------------------------------------------------------------------------	--------------------------------------

Power Supply Accessories - Power Adapter

PPBX-0012		Power Adapter AC 100~240V (US), for A3x, A4x, A88, A9x, Z31, Z8x, Z9x
PPBX-0013		Power Adapter AC 100~240V (EU), for A3x, A4x, A88, A9x, Z31, Z8x, Z9x

PPBX-0014  Power Adapter AC 100~240V (UK), for A3x, A4x, A88, A9x, Z31, Z8x, Z9x

PPBX-0026  Power Adapter AC 100~240V (US) for A3x, A4x, A7x, A88, A9x, Z3x, Z4x, Z7x, Z8x, Z9x

Audio Devices - Microphone

PMIC-0100  Active Microphone Omnidirectional for all Cameras with Line-in Audio

PMIC-0201  Passive Microphone Omnidirectional for all Cameras with Mic-In Audio using Cable Wire or Terminal Connector, 2m cable

