

A83

2MP Outdoor Zoom Dome with D/N, Adaptive IR, Extreme WDR, ELLS, 4.3x Zoom Lens



- 2 Megapixel
- Day & Night with Extreme Low Light Sensitivity and Adaptive IR LED
- 4.3x Zoom Lens with f2.8-12mm/F1.4-F2.8, P-Iris, Auto focus (for installation)
- Extreme WDR
- H.265 Compression
- Wide Angle
- Event trigger, response and notification

► Specifications

Device

Product Type	Zoom Dome
Maximum Resolution	2MP
Application Environment	Outdoor
Image Sensor	Progressive Scan CMOS
Sensor Size	1/2.8 "
Effective Pixels	1945(H) X 1097(V) (2.13 MP)
Day / Night	Yes
Low Light Sensitivity	Extreme
Minimum Illumination	Color: 0.002 lux at F1.4; B/W: 0.001 lux at F1.4; B/W: 0 lux (IR LED on)
Color to B/W Switch	ISP based switch, configurable
Mechanical IR Cut Filter	Yes
IR Sensitivity Range	700-1150nm
IR LED	Adaptive IR LED x 12 (850 nm)
IR Working Distance	30m
Electronic Shutter	1/5-1/64000 second (manual mode); 1/5-1/64000 second (auto mode)

Horizontal Resolution (TV Lines)	1100 TVL
S/N Ratio	75 dB

Lens

Focal Length	Zoom, f2.8-12mm
Aperture	F1.4-F2.8
Zoom Ratio	4.3x optical zoom
Zoom Application	Camera Installation
Iris	P-Iris
Focus	Auto focus
Lens Mount	Board mount
Horizontal Viewing Angle	88° - 25°
Vertical Viewing Angle	57° - 19°
Viewing Angle Adjustment	Pan: -135°-135°, Tilt: 0°-90°, Rotation: -90°-90°

PTZ

Pan, Tilt or Zoom protocol	Pelco-D, Pelco-P, ACTi URL command
----------------------------	------------------------------------

Video

Compression	H.265, H.264 (Baseline/ Main/ High profile), MJPEG
Maximum Frame Rate vs. Resolution	30 fps at 1920 x 1080 30 fps at 1280 x 720 30 fps at 720 x 480 30 fps at 640 x 480 30 fps at 320 x 240
Multi-Streaming	Simultaneous dual streams based on two configurations
Bit Rate	28Kbps - 12Mbps (per stream)
Bit Rate Mode	Constant, Variable
Wide Dynamic Range	Extreme WDR (142 dB)
Image Enhancement	White Balance, Brightness, Contrast, Sharpness, Automatic gain control, Flickerless, Digital Image Stabilizer (DIS, EIS), Defogging
Digital Noise Reduction	2D + 3D DNR
Privacy Mask	4 configurable regions
Text Overlay	Yes
On-Screen Graphics (Picture Overlay)	Yes
Built-in Analytics	Tampering Detection
Server-based Analytics	Object Line Counting, People Counting, Face Detection, Object Based Motion Detection, Tamper, Object Line Crossing Detection, Object Enter Area Detection, Missing Object Detection, Unattended Object Detection, Smoke Detection, Heat Map, Dwell Time, Direction Detection, Automatic License Plate Recognition, People Queue Detection, (Require PC-based or standalone IVS or ALPR Server. Contact ACTi support for recommendations on how to maximize analytical accuracy)
Image Orientation	Flip, Mirror, Rotation (Corridor mode)

Audio

Audio Type	2-way, Mic-in, Line-in, Line-out
Audio Compression	8 kHz, Mono, G.711

Network

Network Protocol & Service	IPv4/v6, TCP, UDP, DHCP, PPPoE, HTTP, HTTPS, DNS, DDNS, NTP, RTP, RTSP, RTCP, SMTP, FTP, IGMP, ICMP, ARP, Bonjour, UPnP, QoS, SNMP
Ethernet Port	1 x RJ-45 connector
Security	IP address filtering, HTTPS encryption, Password protected user level, Anonymous login

Event

Event Trigger	Video motion detection (3 regions), External device through digital input, Sound detection, Tampering detection, Video streams loss
Event Response	Notify control center, Change camera settings, Command other devices, E-mail notification with snapshots, Play the audio file, Push notification to mobile device, Save video to local storage, Upload video to NVR server, Upload video or snapshot to FTP server, Activate external device through digital output

System

Watchdog	Support
----------	---------

Integration

Unified Solution	Fully compatible with ACTi software
GPS Position	Manual setting
Edge Recording	Support (integration with NVR by ONVIF Profile G or proprietary protocol)*
ONVIF Compliant	Yes, Profile S, Profile G, Profile T, Profile Q
Web Browser	IE 11
Auto Firmware Upgrade	Yes

Interface

Audio Interface	Terminal block
Analog Video Output	1 x CVBS, Terminal block, for installation only
Local Storage	MicroSDHC, MicroSDXC Memory Card Slot (card not included, up to 128GB, Kingston or Sandisk only)
Digital Input/Output	1/1 (Terminal block), DC Output Voltage: 5V
Operating Button	Reset Button

General

Power Source	DC 12V, PoE Class 3 (IEEE802.3af)
Power Consumption	10 W (PoE, IR on), 8 W (DC, IR on)
Weight	877.5g (1.935lb)
Dimensions	(Ø x H): 139.95mm x 131.17mm (5.509" x 5.164")
Environmental Casing	Weatherproof (IP66), Vandal proof (IK10)
Corrosion Protection	Optional for project request. Chassis corrosion resistance at the seashore approximately 2-3 years.

Mount Type	Surface, Pendant, Wall Mount
Starting Temperature	-20°C ~ 50°C (-4°F ~ 122°F)
Operating Temperature	-40°C ~ 50°C (-40°F ~ 122°F)
Operating Humidity	20% - 80% RH
Approvals	CE Class A, FCC Class A, EAC, IP66, IK10, NEMA 4X
Real-time Clock (RTC)	No
Warranty	3 Year(s). For extended warranty offering, see http://www.acti.com/support/warranty

* Edge Recording function is integrated with NVR 3 Corporate / NVR 3 Business / INR / GNR series.

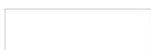

► Photo Indication



- 1 Ethernet Port
- 2 Digital Input/Output
- 3 Memory Card Slot
- 4 Reset Button
- 5 DC 12V Power Input



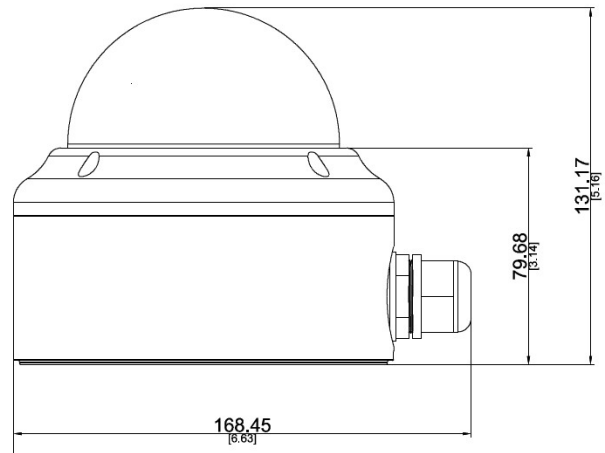
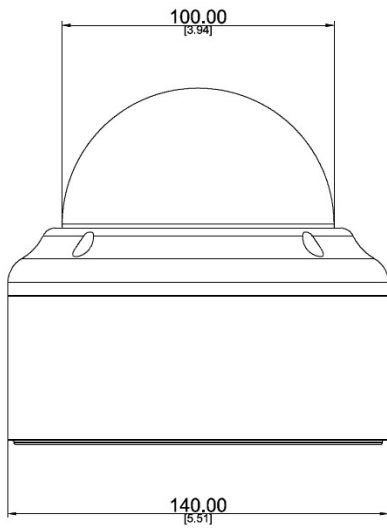















► Dimension Diagram



Unit: mm [inch]

► Related Products

Mounting Accessories - Camera Mount

PMAX-0102		Straight Tube
PMAX-0103		Straight Tube with Bracket
PMAX-0104		Extension Tube
PMAX-0113		Pendant Mount (for A8x, except A88)
PMAX-0302		Gooseneck with Bracket
PMAX-0303		Gooseneck
PMAX-0321		Heavy Duty Wall Mount for Outdoor Domes (for A8x, Z83, Z84, except A88)
PMAX-0402		Corner Mount
PMAX-0503		Pole Mount (for PMA-0102, PMA-0312, PMA-0313, PMA-0314, PMA-0702, PMA-1106, PMA-1107), supports 5.25" to 8.5" Poles
PMAX-0505		Pole Mount (for B4x, B41x, E44, E45, E46, E48, E44A, E45A, E46A, E41x, I4x, PMA-0312, PMA-0313, PMA-0314, PMA-0330), supports 2" to 3" Poles
PMAX-0511		Pole Mount (for A8x), supports 5.25" to 8.5" Poles
PMAX-0702		Junction Box for PTZ and Dome Cameras
PMAX-0704		Junction Box (for A4x, B4x, B41x, E44, E45, E46, E48, E44A, E45A, E46A, E41x, I4x, PMA-0203~PMA-0205)
PMAX-0807		Gangbox Converter (for PMA-0102, PMA-0312, PMA-0313, PMA-0314, PMA-0321), supports Two-Gang Boxes
PMAX-0808		Converter Ring, 1.5" NPT for Third-Party Mounting Accessories
PMAX-0810		Mount Kit and Converter Ring, 1.5" NPT for Third-Party Mounting Accessories (for A8x, except A88)
PMAX-0813		Gang Box Converter (for A8x, except A88), supports Two-Gang Boxes
PMAX-1027		Flush Mount (for A61, A62, A8x, except A88)

Note: Some mounting accessories may need additional accessories for installation. Please check www.acti.com/mountingselector for more information.

Power Supply Accessories - Power Adapter

PPBX-0011  Power Adapter AC 100~240V, with universal connectors for all DC12V powered devices

Network & Storage Peripherals - Data Switch

PPSW-0102  PLANET FGSD-1011HP 8-Port 802.3at PoE Switch (PoE Budget 120W)

PPSW-0105  PLANET GS-4210-8P2C 8-Port Gigabit 802.3at Managed PoE Switch (PoE Budget 120W)

PPSW-1101  PLANET GS-4210-24PL4C 24-Port Gigabit 802.3at Managed PoE Switch (PoE Budget 440W)

PPSW-3100  PLANET FGSW-1816HPS 16-Port 802.3at PoE Switch (PoE Budget 220W)

Extenders - PoE Extender

PPEX-0100  Veracity OUTREACH Max Power over Ethernet (PoE) Extender

Extenders - PoE over Coaxial Extender Kit

PPOC-0100  Planet LRP-101C-KIT Power over Coax Adapter Kit

Audio Devices - Microphone

PMIC-0100  Active Microphone Omnidirectional for all Cameras with Line-in Audio

PMIC-0201  Passive Microphone Omnidirectional for all Cameras with Mic-In Audio using Cable Wire or Terminal Connector, 2m cable

Illuminators - IR LED Illuminator

PLED-0200  SPINLUX (SL-A2IRXX10-24CL) IR Illuminator 10° Angle with 120 m approx. range

PLED-0201  SPINLUX (SL-A2IRXX25-24CL) IR Illuminator 25° Angle with 50 m approx. range