

A86

5MP Outdoor Zoom Dome with D/N, Adaptive IR, Extreme WDR, SLLS, 5x Zoom Lens



- 5 Megapixel
- Day & Night with Superior Low Light Sensitivity and Adaptive IR LED
- 5x Zoom Lens with f2.7-13.5/F1.4-F3.3, Auto focus (for installation)
- Extreme WDR
- H.265 Compression
- Wide Angle
- Event trigger, response and notification

► Specifications

Device

Product Type	Zoom Dome
Maximum Resolution	5MP
Application Environment	Outdoor
Image Sensor	Progressive Scan CMOS
Sensor Size	1/2.8 "
Effective Pixels	2592(H) X 1944(V) (5.04 MP)
Day / Night	Yes
Low Light Sensitivity	Superior
Minimum Illumination	Color: 0.018 lux (30 IRE); B/W: 0 lux (IR LED on)
Color to B/W Switch	ISP based switch, configurable
Mechanical IR Cut Filter	Yes
IR LED	Adaptive IR LED
IR Working Distance	30m
Electronic Shutter	1/5-1/64000 second (manual mode); 1/5-1/64000 second (auto mode)
Horizontal Resolution (TV Lines)	1600 TVL

S/N Ratio	75 dB
-----------	-------

Lens

Focal Length	Zoom, f2.7-13.5mm
Aperture	F1.4-F3.3
Zoom Ratio	5x optical zoom
Zoom Application	Camera Installation
Iris	Adaptive iris
Focus	Auto focus
Lens Mount	Board mount
Horizontal Viewing Angle	96.8° - 30.7°
Vertical Viewing Angle	70.4° - 23.1°
Viewing Angle Adjustment	Pan: 360°, Tilt: 90°, Rotation: ±90°

Video

Compression	H.265, H.264 (Main profile), MJPEG
Maximum Frame Rate vs. Resolution	30 fps at 2560 x 1920 30 fps at 2048 x 1536 30 fps at 1920 x 1080 30 fps at 1280 x 960 30 fps at 1280 x 720 30 fps at 800 x 600 30 fps at 720 x 480 30 fps at 640 x 480 30 fps at 320 x 240
Multi-Streaming	Simultaneous triple streams based on configurations of video resolution, compression format, and frame rate
Bit Rate Mode	Constant, Variable
Wide Dynamic Range	Extreme WDR (125 dB)
Image Enhancement	White Balance, Brightness, Backlight compensation (BLC), Contrast, Saturation, Sharpness, Automatic gain control, Flickerless, Digital Image Stabilizer (DIS, EIS), Defogging
Digital Noise Reduction	2D + 3D DNR
Privacy Mask	4 configurable regions
Text Overlay	Yes
On-Screen Graphics (Picture Overlay)	Yes
Built-in Analytics	Tampering Detection
Server-based Analytics	Object Line Counting, People Counting, Face Detection, Object Based Motion Detection, Tamper, Object Line Crossing Detection, Object Enter Area Detection, Missing Object Detection, Unattended Object Detection, Smoke Detection, Heat Map, Dwell Time, Direction Detection, Automatic License Plate Recognition, (Require PC-based or standalone IVS or ALPR Server. Contact ACTi support for recommendations on how to maximize analytical accuracy)
Image Orientation	Flip, Mirror, Rotation (Corridor mode)

Audio

Audio Type	2-way, Mic-in, Line-in, Line-out
Audio Compression	8 kHz, Mono, G.711

Network

Network Protocol & Service	IPv4/v6, TCP, UDP, DHCP, PPPoE, HTTP, HTTPS, DNS, DDNS, NTP, RTP, RTSP, RTCP, SMTP, FTP, IGMP, ICMP, ARP, Bonjour, UPnP, QoS, SNMP, IEEE 802.1X
Ethernet Port	1 x Ethernet (10/100 Base-T), RJ-45 pigtail connector
Security	IP address filtering, HTTPS encryption, Password protected user level, Anonymous login

Video Analytics

Analysis Source Type	Video
----------------------	-------

Event

Event Trigger	Video motion detection (3 regions), External device through digital input, Sound detection, Tampering detection, Video streams loss
Event Response	Notify control center, Change camera settings, Command other devices, E-mail notification with snapshots, Play the audio file, Push notification to mobile device, Save video to local storage, Upload video to NVR server, Upload video or snapshot to FTP server, Activate external device through digital output

System

System Monitor	CPU loading, memory usage and network statistics via API
Watchdog	Support

Integration

Unified Solution	Fully compatible with ACTi software
Edge Recording	Support (integration with NVR by ONVIF Profile G or proprietary protocol)**
ONVIF Compliant	Yes, Profile S, Profile G, Profile T, Profile Q
Web Browser	IE 11, Google Chrome*, Microsoft Edge*, Apple Safari*
Auto Firmware Upgrade	Yes

Interface

Local Storage	MicroSDHC, MicroSDXC Memory Card Slot (card not included, up to 256GB, Kingston or Sandisk only)
Digital Input/Output	1/1 (Terminal block), DC Output Voltage: 5V
Operating Button	Reset Button

General

Power Source	DC 12V, PoE Class 3 (IEEE802.3af)
Power Consumption	12.95 W (PoE)
Dimensions	(Ø x H): 139.38mm x 129.75mm (5.48" x 5.10")
Environmental Casing	Weatherproof (IP66), Vandal proof (IK10)
Corrosion Protection	Optional for project request. Chassis corrosion resistance at the seashore approximately 2-3 years.
Mount Type	Surface, Pendant, Wall Mount
Starting Temperature	-20°C ~ 50°C (-4°F ~ 122°F)
Operating Temperature	-40°C ~ 50°C (-40°F ~ 122°F)
Operating Humidity	20% - 80% RH

Approvals	CE Class A, FCC Class A, EAC, IP66, IK10
Real-time Clock (RTC)	Yes
Warranty	3 Year(s). For extended warranty offering, see http://www.acti.com/support/warranty

* cross-browser compatibility: Motion Detection and Intelligent Video configurations are not available. ** Edge Recording function is integrated with NVR 3 Corporate / NVR 3 Business / INR / GNR series.

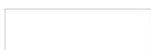

► Photo Indication

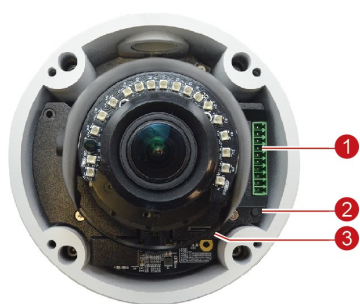

- 1 Input and Output Connector
 - DC 12V Power Input
 - Digital Input / Output
 - Audio Input / Output
 - Analog Video Output
- 2 Reset Button
- 3 Memory Card Slot
- 4 Ethernet Port



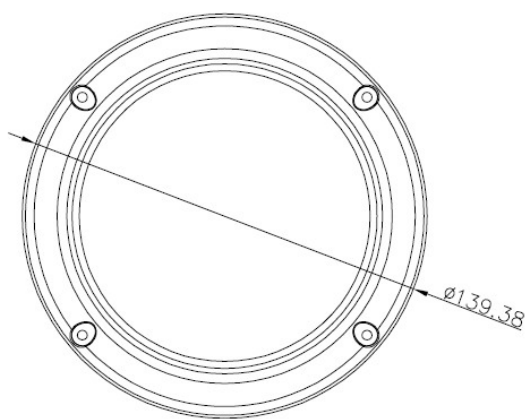
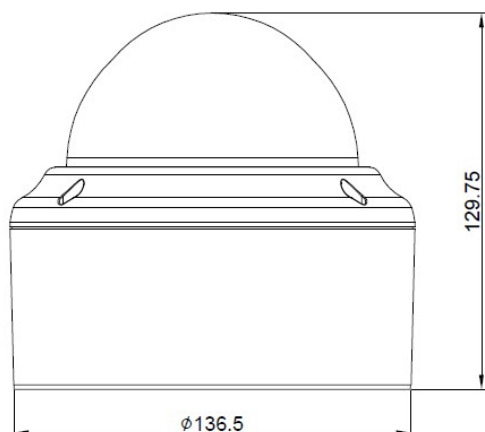















► Dimension Diagram



Unit: mm [inch]

► Related Products

Mounting Accessories - Camera Mount

PMAX-0102		Straight Tube
PMAX-0103		Straight Tube with Bracket
PMAX-0104		Extension Tube
PMAX-0113		Pendant Mount (for A8x, except A88)
PMAX-0302		Gooseneck with Bracket
PMAX-0303		Gooseneck
PMAX-0321		Heavy Duty Wall Mount for Outdoor Domes (for A8x, Z83, Z84, except A88)
PMAX-0402		Corner Mount
PMAX-0503		Pole Mount (for PMA-0102, PMA-0312, PMA-0313, PMA-0314, PMA-0702, PMA-1106, PMA-1107), supports 5.25" to 8.5" Poles
PMAX-0505		Pole Mount (for B4x, B41x, E44, E45, E46, E48, E44A, E45A, E46A, E41x, I4x, PMA-0312, PMA-0313, PMA-0314, PMA-0330), supports 2" to 3" Poles
PMAX-0511		Pole Mount (for A8x), supports 5.25" to 8.5" Poles
PMAX-0702		Junction Box for PTZ and Dome Cameras
PMAX-0704		Junction Box (for A4x, B4x, B41x, E44, E45, E46, E48, E44A, E45A, E46A, E41x, I4x, PMA-0203~PMA-0205)
PMAX-0807		Gangbox Converter (for PMA-0102, PMA-0312, PMA-0313, PMA-0314, PMA-0321), supports Two-Gang Boxes
PMAX-0808		Converter Ring, 1.5" NPT for Third-Party Mounting Accessories
PMAX-0810		Mount Kit and Converter Ring, 1.5" NPT for Third-Party Mounting Accessories (for A8x, except A88)
PMAX-0813		Gang Box Converter (for A8x, except A88), supports Two-Gang Boxes
PMAX-1027		Flush Mount (for A61, A62, A8x, except A88)

Note: Some mounting accessories may need additional accessories for installation. Please check www.acti.com/mountingselector for more information.

Dome Covers - Transparent Dome Cover

R701-70009



Transparent Dome Cover (for A8x-10A)

Audio Devices - Microphone

PMIC-0100



Active Microphone Omnidirectional for all Cameras with Line-in Audio

PMIC-0201



Passive Microphone Omnidirectional for all Cameras with Mic-In Audio using Cable Wire or Terminal Connector, 2m cable

