

A955

5MP Deep Learning AI 40x Outdoor PTZ
with IR LED 250m, WDR 150dB



- 5 Megapixel, 40x PTZ
- Frame Rate 60fps
- Endless Pan & Tilt
- Built-in Analytics
- Event trigger, response and notification

► Specifications

Product Profile

Product Type	PTZ
Application Environment	Outdoor
Maximum Resolution	5MP
Image Sensor	Progressive Scan CMOS
Sensor Size	1/2.8 "
Effective Pixels	2608(H) X 1964(V) (5.1 MP)
Day / Night	Yes
Low Light Sensitivity	Extreme
Minimum Illumination	Color: 0.002 lux; B/W: 0 lux (IR LED on)
Mechanical IR Cut Filter	Yes
IR Sensitivity Range	700-1100nm
IR LED	Adaptive IR LED
IR Working Distance	250m
Electronic Shutter	1-1/10000 second (manual mode); 1-1/10000 second (auto mode)
S/N Ratio	75 dB

Lens

Focal Length	Zoom, f4.25-170mm
Aperture	F1.6
Zoom Ratio	40x optical zoom, 10x digital zoom
Iris	P-Iris
Focus	Auto focus
Horizontal Viewing Angle	62.6° - 1.9°
Vertical Viewing Angle	48.8° - 1.4°

PTZ

Manual Panning / Tilting Speed	0.1° - 90°/second, 0.1° - 55°/second
Preset Panning / Tilting Speed	300°/second, 300°/second
Panning Range	360° endless
Tilting Range	-20°~100°
PTZ Control	Remote manual control, Speed Control, Drag to Pan and Tilt, Click to Center, 256 preset points, Auto scan
Absolute Position	Yes

Video

Compression	H.265 Adaptive Stream (equivalent to Zip or Smart Stream or H.265+), H.264, MJPEG
Maximum Frame Rate vs. Resolution	30 fps at 2592 x 1944 48 fps at 2560 x 1440 57 fps at 2048 x 1536 60 fps at 1920 x 1080 60 fps at 1280 x 1024 60 fps at 1280 x 720 60 fps at 1024 x 768 60 fps at 800 x 600 60 fps at 720 x 480 30 fps at 640 x 480 30 fps at 352 x 240 30 fps at 320 x 240
Bit Rate Mode	Constant, Variable
Digital Noise Reduction	2D + 3D DNR
Wide Dynamic Range	Extreme WDR (150 dB)
Image Enhancement	White Balance, Brightness, Contrast, Sharpness, Saturation, Backlight compensation (BLC), Digital Image Stabilizer (DIS, EIS)
Privacy Mask	Yes
Text Overlay	Yes
Built-in Analytics	Deep Learning : Face Recognition, Face Detection, People Detection, Vehicle Detection, Object Based Motion Detection

Analytics

Deep Learning AI	2.0
------------------	-----

Audio

Audio Type	2-way, Line-in, Line-out
Audio Compression	G.711, G.726, AAC, PCM

Network

Network Protocol & Service	IPv4, IPv6, TCP, UDP, DHCP, PPPoE, HTTP, HTTPS, DDNS, NTP, RTP, RTSP, SMTP, FTP, IGMP, ICMP, ARP, UPnP, QoS, SNMP, IEEE 802.1X
Ethernet Port	1 x Ethernet (10/100/1000 Base-T), RJ-45 connector

Security	IP address filtering, HTTPS encryption, Password protected user level, IEEE 802.1X network access control
----------	---

Detection Range

Observation Range	Detection: People 3112m; Vehicle 3176m Observation: People 1235m; Vehicle 1260m Recognition: People 622m; Vehicle 635m Identification: People 311m; Vehicle 318m
-------------------	--

Event

Event Trigger	Video motion detection, External device through digital input, Sound detection, Intelligent event detection
Event Response	E-mail notification with snapshots, Save video to storage, Upload snapshot to FTP server, Activate external device through digital output

System

Watchdog	Support
----------	---------

Integration

Unified Solution	Fully compatible with ACTi software
Edge Recording	Support (integration with NVR by ONVIF Profile G)
ONVIF Compliant	Yes, Profile S, Profile G, Profile T, Profile M
Web Browser	Microsoft Edge(IE mode), Microsoft Edge, Google Chrome, Firefox

Interface

Audio Interface	1/1, Terminal block
Digital Input/Output	4/2 (Terminal block)

General

Power Source	AC 24V, PoE Type 3 Class 6 (IEEE802.3bt)
Power Consumption	59.05 W (AC), 51 W (PoE)
Environmental Casing	Weatherproof (IP66), Vandal proof metal casing (IK10)
Corrosion Protection	Optional for project request. Chassis corrosion resistance at the seashore approximately 2-3 years.
Heater	Yes
Operating Temperature	-40°C ~50°C (-40°F ~ 122°F) heater on
Operating Humidity	10% - 90% RH, non-condensing
Approvals	CE, FCC, IP66, IK10 (metal casing), CNS-16120
Color	White
Warranty	3 Year(s) (1 year in continuous motion). For extended warranty offering, see http://www.acti.com/support/warranty



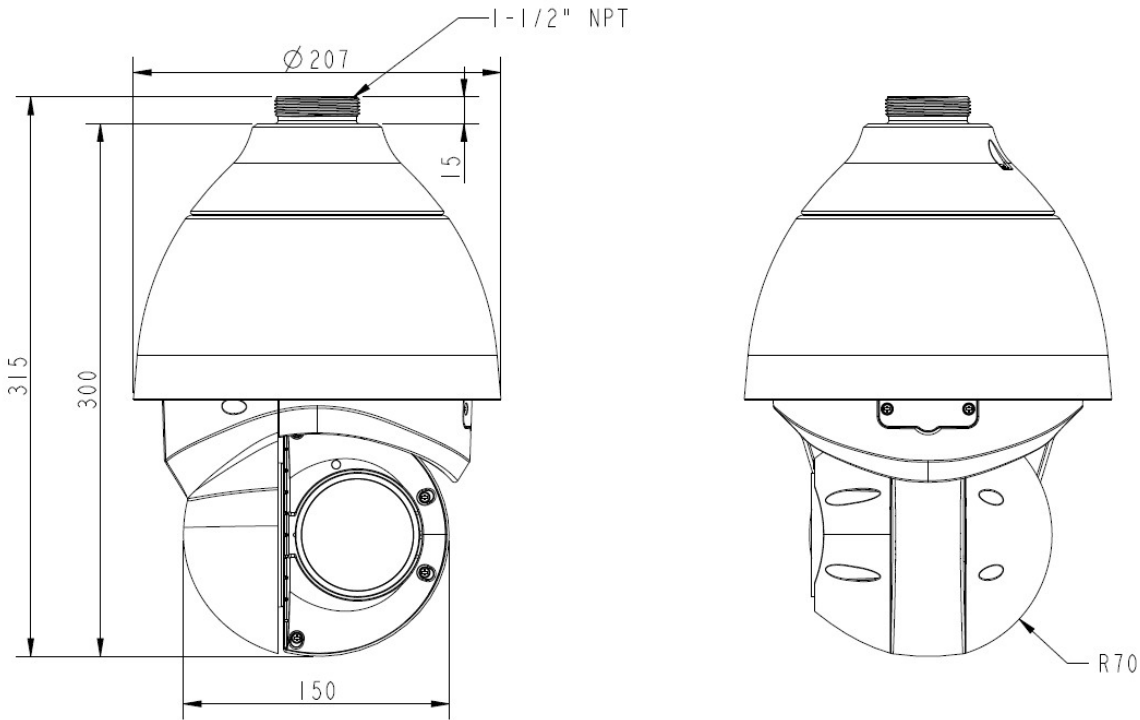



▶ Dimension Diagram



Unit: mm [inch]

▶ Related Products

Mounting Accessories - Camera Mount

PMAX-0115		Pendant Mount (for A950, A951, A952, A956, Z950, Z952)
PMAX-0343		Gooseneck with Bracket with Converter Ring (for Q75)
PMAX-0344		Gooseneck with Converter Ring (for Q75)
PMAX-0346		Heavy Duty Wall Mount with Converter Ring (for Q75, A950, A951, A952, A956)
PMAX-0402		Corner Mount
PMAX-0531		Pole mount for A951
PMAX-0702		Junction Box for PTZ and Dome Cameras

Note: Some mounting accessories may need additional accessories for installation. Please check www.acti.com/mountingselector for more information.

Power Supply Accessories - PoE Injector

PPOE-0202



High PoE injector 90Watt 10/100/1000M/Multi Gigabit PoE Injector (for A952, A956, Z953, Z954, Q83, Q84)