

# AV20576RS-QDRJ45

## Four 5MP Sensors with Remote Setup & 1.5 NPT Quick Disconnect



20MP Resolution  
Motorized Lens 3.3-6.6mm(x4)  
Day and night (ICR)  
True wide dynamic range (WDR)

Two-way audio  
IK10 / IP66  
PoE+ (IEEE 802.3at Class 4)  
IR LED (30m / 98.4 ft (6ea))

Remotely Adjustable 3-Axis Gimbal  
NDAA Compliant  
Supports ONVIF

### SPECIFICATIONS

Camera Imaging Specifications	
Image Sensor (CMOS)	20MP (5MP x 4) CMOS Progressive Sensor
Optical Format	1/2.8"
Pixel Pitch	2.0µm
Minimum Illumination	(Color (Day Mode)) 0.15 Lux (B/W (Night Mode)) 0.15 Lux
Full FOV Resolution	(Total) 10368 H x 1944 V (Per Sensor) 2592 H x 1944 V
IR Illumination	No
Dynamic Range	DOL WDR 120db
Frame Rates	(At Max Resolution) 30fps (20MP) (Multi-Stream) Up to 30fps (20MP) + 30fps (20MP) + 30fps (1.2MP) Enhanced WDR on
Lens (x4)	3.3-6.6mm, F1.8, H-FOV = 42°-96°
Programmability	
Optics	Remote focus / zoom
Low-Light Performance	NightView™ technology
Programmable Shutter Speed	Auto/manual 0.1ms - 500ms
Motion Detection	Real-time, 1024 detection zones
Privacy Masking	Unlimited
Backlight Compensation	Auto
White Balance Mode	Auto/manual
Gain Control	Auto
Flicker Control	5Hz-255Hz adjustable
Image Rotation	180°
Scaling	(20MP) 2592x1944, 2560x1440, 2304x1296, 2048x1536, 1920x1080, 1600x1200, 1296x972, 1280x960, 1280x720, 800x600, 640x480 (32MP) 3840x2160, 2592x1944, 2560x1440, 2304x1296, 2048x1536, 1920x1080, 1600x1200, 1296x972, 1280x960, 1280x720, 800x600, 640x480, 640x360
Wide Dynamic Range	Adjustment between WDR and LDR modes
Efficiency	SNAPstream+ (Smart Noise Adaptation and Processing) Bit rate and bandwidth limitation control
Miscellaneous	Programmable brightness, contrast, sharpness, saturation, hue
Password	16-digit ASCII character password
On-Screen Display (OSD)	Time/date/camera name/custom text
Standard Video Analytics	Motion Detection Camera Tamper Intrusion Detection Line Crossing Loitering
Optional Advanced Video Analytics	Object Classification (Person/Vehicle) Object Left/Removed People/Vehicle Counting
Included Accessories	(RS) Power Cable, Alarm Cable (RSIR) Cap, Power Cable, Alarm Cable, 2x Audio Cables (In/Out)
Data Transmission	
Compression Type	H.265/H.264 (MPEG-4, Part 10)/Motion JPEG 21 levels of quality
Bit Rate Control	128K-8000K
Smart Codec	Smart GOP
Network Protocols	SNMP, HTTP, HTTPS, IPv6, IPv4, SSL, TCP/IP, UPnP, UDP, RTCP, RTSP, RTP, SMTP, NTP, DHCP, FTP, 802.1x, Zero Configure
Network Interface	10/100/1000Mbps Ethernet, RJ45
Max Camera Bandwidth	40Mbps (10Mbps per sensor)
Multi-Streaming	2 x H.265/H.264 stream, 1 x M-JPEG stream (per sensor)
Users	Live Viewing/Administrator for up to 10 clients
Compliance	
Industry Standard	ONVIF Profile S, G, M, and T conformant
Listings	UL62368-1 & CAN/CSA-C22.2 No.62368-1, E489591
FCC Compliance	47 CFR 15 Class A
Environmental	RoHS, REACH, WEEE
Markings	(CE): EN55032 Class A, EN55035, EN61000-3-2, EN61000-3-3, EN60950, IEC 62471
Mechanical	IK-10 (EN62262), IP66 (EN60529)
Event Management	
Event Trigger	Motion detection, tampering detection, alarm in
Notifications	Send/record message via e-mail/FTP/NAS, record JPG/mp4
Electrical	
Alarm Input/Output	1 input (wet contact)/1 output (wet contact)
Power Over Ethernet	(RS) IEEE 802.3at (PoE+), Class 4 (RSIR) IEEE 802.3bt (PoE++), Class 5
Auxiliary Power	(RS) 24-48V DC, 24V AC (RSIR) 24V DC, 24V AC
Power Consumption	(RS) 25.5W max (RSIR) 40W max
Audio Electrical	
Streaming	Two-way
Compression	G.711 PCM 8 kHz/8 bit
Input/Output	Line in (requires amplification) / Line output
IR Illuminator (RSIR Models Only)	
LEDs	6 pcs 850nm LEDs
Projection Distance	98.4ft (30m) IR distance (max) / 360° IR angle
Environmental	
Operating Temperature	-40°C (-40°F) to +50°C (122°F)
Humidity	0% to 90% (non-condensing)
Storage Temperature	-40°C (-40°F) to +60°C (140°F)
Mechanical	
Casing	Die-cast aluminum chassis with polycarbonate dome bubble IP66 weather proof standard Impact resistant, IK-10 rated
Gimbal	(RS) Remotely adjustable, 3-axis w/360° pan, 135° tilt (RSIR) Remotely adjustable, 3-axis w/360° pan, 90° tilt



### PRODUCT IMAGE



### DIMENSIONS

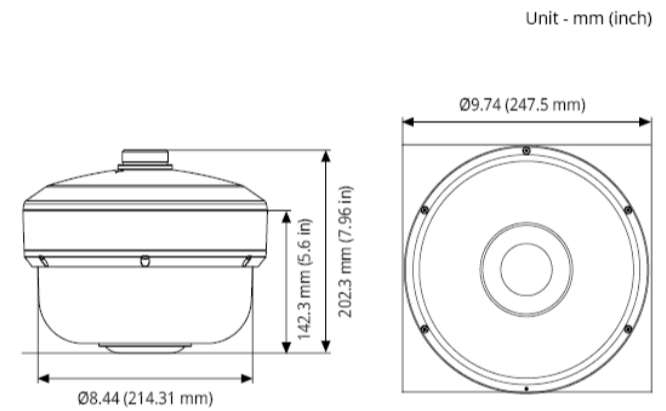



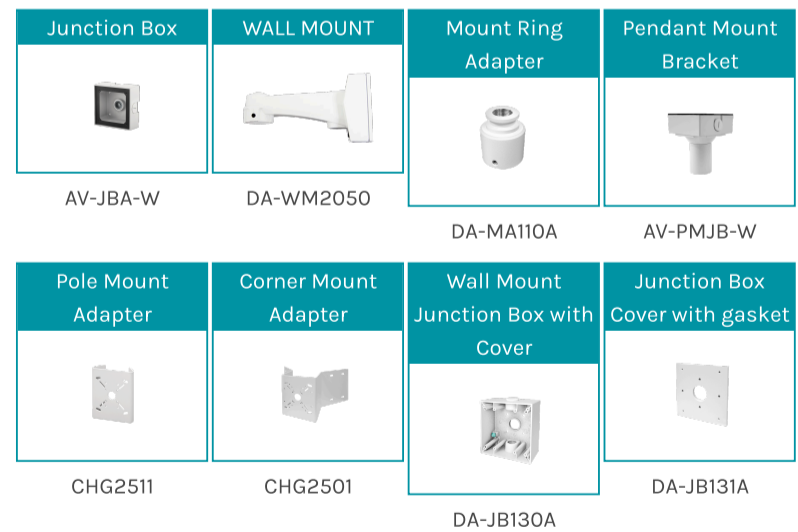









### ACCESSORIES (OPTIONAL)



<b>Dimensions</b>	(RS) (Unit) Ø 8.8" (223.4mm) x 4.9" H (125.4mm) (RS) (Bubble Only) Ø 7.2" (183.3mm) x 2.3" H (59.3mm) (RS) (Packaged) 11.1" W (281mm) x 11.1" L (281mm) x 7.4" H (188mm) (RSIR) (Unit) Ø 9.72" (247mm) x 7.95" H (202mm) (RSIR) (Bubble Only) Ø 8.44" (214.31mm) x 3" H (76.3mm) (RSIR) (Packaged) 28.54" W (725mm) x 14.57" L (370mm) x 12.99" H (330mm)
<b>Weight</b>	(RS) (Unit) 5.2lbs (2.36kg) (RS) (Packaged) 5.9lbs (2.68kg) (RSIR) (Unit) 7.55lbs (3.43kg) (RSIR) (Packaged) 10.09lbs (4.58kg)
<b>On Board Storage</b>	(RS) MicroSDXC slot up to 1TB (card not included) (RSIR) 2 x MicroSDXC slot up to 1TB (card not included)
<b>Body Color</b>	Arecont Vision® White (Pantone® Cool Gray 1C)

101 Wrangler Dr. Suite 201, Coppell, TX 75019 | +1 . 469 . 635 . 6800 | IDISAMERICAS.COM sales@idisamericas.com

## ACCESSORY CONFIGURATION BY INSTALLATION ENVIRONMENT

PRODUCT	INSTALLATION ENVIRONMENT	ACCESSORY CONFIGURATION
AV20576RS-QDRJ45	WALL	 <b>WALL</b> Model: AV-JBA-W
		or
		 <b>WALL</b> Model: DA-WM2050
	WALL	 <b>WALL</b> Model: DA-MA110A
		 <b>CEILING</b> Model: AV-PMJB-W
		POLE
	 <b>POLE</b> Model: CHG2511	
	 <b>POLE</b> Model: DA-MA110A	
	CORNER	 <b>CORNER</b> Model: DA-WM2050
		 <b>CORNER</b> Model: CHG2501
		 <b>CORNER</b> Model: DA-MA110A
	ETC	 <b>ETC</b> Model: DA-MA110A
		or
		 <b>ETC</b> Model: DA-JB130A
		or
		 <b>ETC</b> Model: DA-JB131A

