

B45

2MP with D/N, Adaptive IR, Basic WDR, SLLS, 10x Zoom Lens



- 2 Megapixel
- Day & Night with Superior Low Light Sensitivity and Adaptive IR LED
- 10x Zoom Lens with f4.9-49mm/F1.6-F3.0, DC iris, Auto focus
- Basic WDR
- Event trigger, response and notification

► Specifications

Device

| | |
|--------------------------|---|
| Product Type | Zoom Bullet |
| Maximum Resolution | 2MP |
| Application Environment | Outdoor |
| Image Sensor | Progressive Scan CMOS |
| Sensor Size | 1/2.8 " |
| Effective Pixels | 1984(H) X 1225(V) (2.43 MP) |
| Day / Night | Yes |
| Low Light Sensitivity | Superior |
| Minimum Illumination | Color: 0.1 lux at F1.8 (30 IRE, 2400 K); B/W: 0 lux at F1.8 (IR LED on) |
| Color to B/W Switch | ISP based switch, configurable |
| Mechanical IR Cut Filter | Yes |
| IR Sensitivity Range | 700-1100nm |
| IR LED | Adaptive IR LED x 27 (850 nm) |
| IR Working Distance | 40m |
| Electronic Shutter | 1/5-1/2000 second (manual mode); 1/5-1/10000 second (auto mode) |

| | |
|----------------------------------|----------|
| Horizontal Resolution (TV Lines) | 1450 TVL |
| S/N Ratio | 52 dB |

Lens

| | |
|--------------------------|---|
| Focal Length | Zoom, f4.9-49mm |
| Aperture | F1.6-F3.0 |
| Zoom Ratio | 10x optical |
| Zoom Speed | 2.5 second (wide to tele) |
| Zoom Application | Camera Installation, Auto Zoom by Event, Manual Operation |
| Iris | DC iris |
| Focus | Auto focus |
| Lens Mount | Board mount |
| Horizontal Viewing Angle | 57.8° - 6.9° |
| Vertical Viewing Angle | 33.8° - 4.0° |

PTZ

| | |
|----------------------------|---|
| Absolute Position | Yes |
| Pan, Tilt or Zoom protocol | Visca, Pelco-D, Pelco-P, ACTi URL command |

Video

| | |
|-----------------------------------|---|
| Compression | H.264 (Baseline/ Main/ High profile), MJPEG |
| Maximum Frame Rate vs. Resolution | 30 fps at 1920 x 1080 30 fps at 1280 x 720 30 fps at 800 x 600 30 fps at 640 x 480 15 fps at 320 x 240 |
| Multi-Streaming | Simultaneous dual streams based on two configurations |
| Bit Rate | 28Kbps - 6Mbps (per stream) |
| Bit Rate Mode | Constant, Variable |
| Wide Dynamic Range | Basic WDR (75 dB) |
| Image Enhancement | White Balance, Brightness, Contrast, Sharpness, Automatic gain control, Flickerless |
| Digital Noise Reduction | DNR |
| Privacy Mask | 4 configurable regions for each of 17 preset points |
| Text Overlay | Yes |
| On-Screen Graphics | Yes |
| Server-based Analytics | Object Line Counting, People Counting, Face Detection, Object Based Motion Detection, Tamper, Object Line Crossing Detection, Object Enter Area Detection, Missing Object Detection, Unattended Object Detection, Heat Map, Smoke Detection, Dwell Time, Direction Detection, Automatic License Plate Recognition, People Queue Detection, (Require PC-based or standalone IVS or ALPR Server. Contact ACTi support for recommendations on how to maximize analytical accuracy) |
| Image Orientation | Flip, Mirror |

Audio

| | |
|-------------------|--|
| Audio Type | 2-way, Line-in, Line-out |
| Audio Compression | 8 kHz, 16 bit encoding, Mono, PCM, G.711 |

Network

| | |
|----------------------------|---|
| Network Protocol & Service | IPv4/v6, TCP, UDP, DHCP, PPPoE, HTTP, HTTPS, DNS, DDNS, NTP, RTP, RTSP, RTCP, SMTP, FTP, IGMP, ICMP, ARP, Bonjour, UPnP, QoS, SNMP, IEEE 802.1X |
| Ethernet Port | 1 x RJ-45 connector |
| Security | IP address filtering, HTTPS encryption, Password protected user level, Anonymous login, IEEE 802.1X network access control |

Event

| | |
|----------------|---|
| Event Trigger | Video motion detection (3 regions), External device through digital input, Sound detection, |
| Event Response | Notify control center, Go to Zoom preset point or preset tour, Change camera settings, Command other devices, E-mail notification with snapshots, Play the audio file, Push notification to mobile device, Save video to local storage, Upload video or snapshot to FTP server, Upload video to NVR server, Activate external device through digital output |

Integration

| | |
|--------------------------|--|
| Unified Solution | Fully compatible with ACTi software |
| Software Development Kit | Yes |
| GPS Position | Manual setting |
| ONVIF Compliant | Yes, Profile S, Profile G, Profile T, Profile Q |
| GB28181 Compliant | Yes |
| Web Browser | IE 11 or newer, Firefox with VLC, Chrome with VLC, Safari with QuickTime |
| Auto Firmware Upgrade | Yes |

Interface

| | |
|----------------------|--|
| Audio Interface | Terminal block |
| Local Storage | MicroSDHC, MicroSDXC Memory Card Slot (card not included, up to 256GB) |
| Digital Input/Output | 1/1 |
| Operating Button | Reset Button |

General

| | |
|-----------------------|--|
| Power Source | DC 12V (adapter not included), PoE Class 3 (IEEE802.3af) |
| Power Consumption | 12 W (PoE) |
| Weight | 2355g (5.192lb) |
| Dimensions | (W x H x D): 122.4mm x 223.7mm x 317mm (4.82" x 8.81" x 12.48") |
| Environmental Casing | Weatherproof (IP67), Vandal proof metal casing (IK10) |
| Bundled Accessories | Integrated bracket |
| Mount Type | Ceiling Bracket, Gang Box, Integrated Bracket, Pole Mount |
| Heater | Yes |
| Starting Temperature | -40°C ~ 50°C (-40°F ~ 122°F) within 30 minutes |
| Operating Temperature | -40°C ~ 50°C (-40°F ~ 122°F) |
| Operating Humidity | 10% - 85% RH |
| Approvals | CE Class B, FCC Class B, EAC, IP67, IK10 (metal casing), NEMA 4X, UL (for optional PoE injector and power adapter) |

Real-time Clock (RTC)

Yes

Warranty

3 Year(s). For extended warranty offering, see <http://www.acti.com/support/warranty>

► Photo Indication

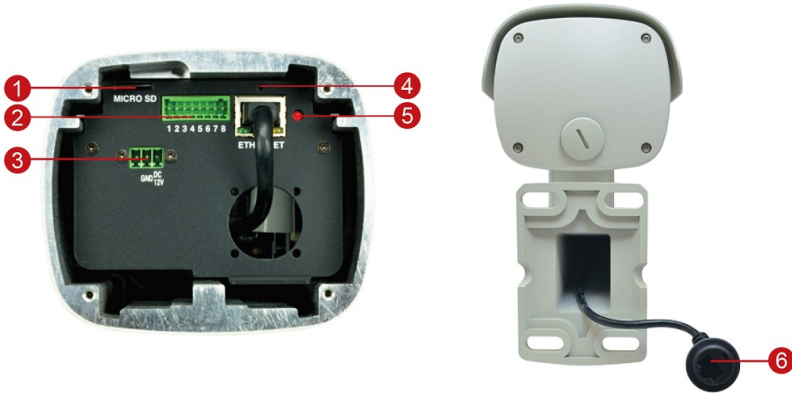

- 1 Memory Card Slot
- 2 Digital Input / Output and Audio-In / Audio-Out
- 3 DC 12V Power Input
- 4 Reset Button
- 5 Power LED
- 6 Ethernet Port



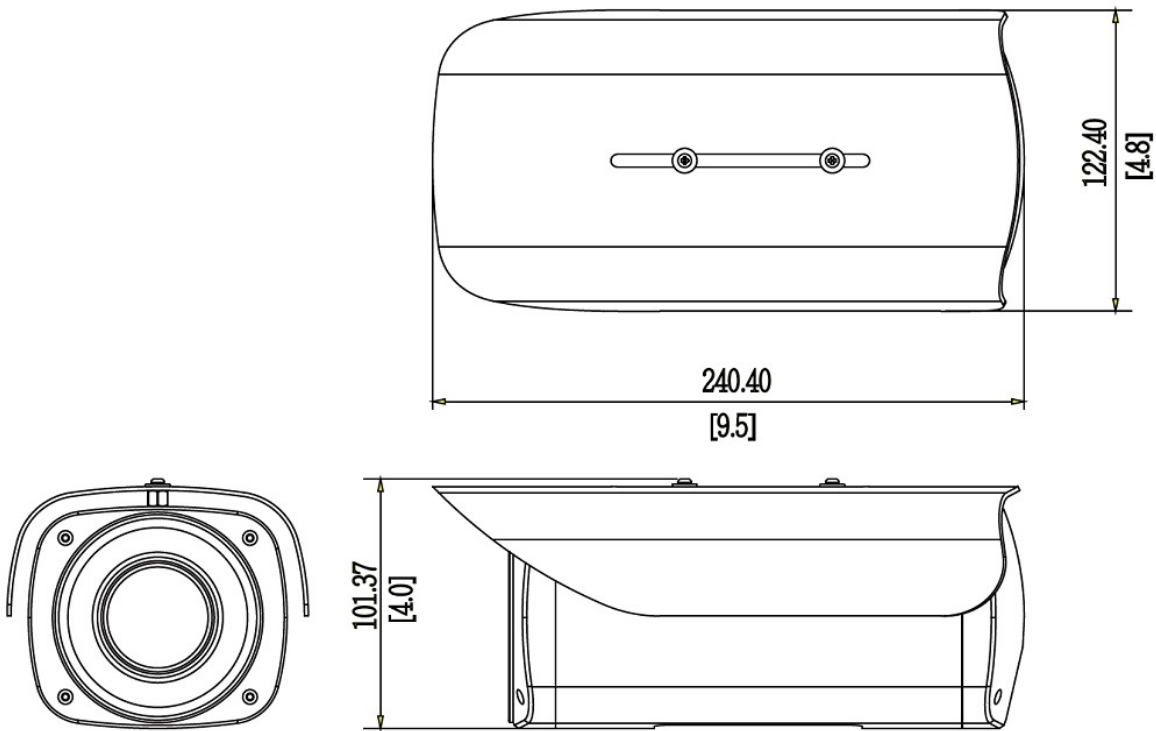



► Dimension Diagram



Unit: mm [inch]

▶ Related Products

Mounting Accessories - Camera Mount

| | | |
|------------|--|--|
| PMAX-0504 |  | Pole Mount (for B4x, B41x, E44, E45, E46, E48, E44A, E45A, E46A, E41x, I4x, PMAX-0330), supports 3.25" to 7.0" Poles |
| PMAX-0505 |  | Pole Mount (for B4x, B41x, E44, E45, E46, E48, E44A, E45A, E46A, E41x, I4x, PMAX-0312, PMAX-0313, PMAX-0314, PMAX-0330), supports 2" to 3" Poles |
| PMAX-0508 |  | Pole Mount (for PMAX-0203, PMAX-0204, PMAX-0205, PMAX-0206, PMAX-0704), supports 3" to 9" Poles |
| PMAX-0704 |  | Junction Box (for A4x, B4x, B41x, E44, E45, E46, E48, E44A, E45A, E46A, E41x, I4x, PMAX-0203~PMAX-0205) |
| PMAX-0806 |  | Gang Box Converter (for B4x, E39, E44, E45, E46, E44A, E45A, E46A), supports 4" Round and 4" Octagon Boxes |
| PMAX-1300 |  | Ceiling Bracket (for B4x) |
| R708-00001 |  | Bracket (for B41, B44, B45, B46, B47, B49, B410, I44, I45, I47) |

Note: Some mounting accessories may need additional accessories for installation. Please check www.acti.com/mountingselector for more information.



Bullet Covers - Front Cover

| | | |
|------------|---|---|
| R700-00007 |  | Front Cover (for B4x, B410, I4x except I42 and I48) |
|------------|---|---|





Power Supply Accessories - Power Adapter

| | | |
|-----------|---|--|
| PPBX-0011 |  | Power Adapter AC 100~240V, with universal connectors for all DC12V powered devices |
|-----------|---|--|

Power Supply Accessories - PoE Injector

| | | |
|-----------|---|---|
| PPOE-0000 |  | POE Injector , IEEE 802.3af compliant, AC 100~240V, for US & Japan |
| PPOE-0001 |  | PoE Injector IEEE 802.3af compliant, AC 100~240V, with universal connectors |

Network & Storage Peripherals - Data Switch

| | | |
|-----------|---|--|
| PPSW-0100 |  | PLANET FGSD-910HP 8-Port 802.3at PoE Switch (PoE Budget 120W) |
| PPSW-0101 |  | PLANET GS-4210-8P2T2S 8-Port Gigabit 802.3at Managed PoE Switch (PoE Budget 240W) |
| PPSW-0102 |  | PLANET FGSD-1011HP 8-Port 802.3at PoE Switch (PoE Budget 120W) |
| PPSW-1101 |  | PLANET GS-4210-24PL4C 24-Port Gigabit 802.3at Managed PoE Switch (PoE Budget 440W) |

| | | |
|-----------|---|--|
| PPSW-2101 |  | 4-Port 802.3at PoE Switch (PoE Budget 62W) |
|-----------|---|--|

| | | |
|-----------|---|--|
| PPSW-3100 |  | PLANET FGSW-1816HPS 16-Port 802.3at PoE Switch (PoE Budget 220W) |
|-----------|---|--|

Extenders - PoE Extender

| | | |
|-----------|---|--|
| PPEX-0100 |  | Veracity OUTREACH Max Power over Ethernet (PoE) Extender |
|-----------|---|--|

Extenders - PoE over Coaxial Extender Kit

| | | |
|-----------|---|---|
| PPOC-0100 |  | Planet LRP-101C-KIT Power over Coax Adapter Kit |
|-----------|---|---|

Audio Devices - Microphone

| | | |
|-----------|---|--|
| PMIC-0100 |  | Active Microphone Omnidirectional for all Cameras with Line-in Audio |
|-----------|---|--|

Illuminators - IR LED Illuminator

| | | |
|-----------|---|--|
| PLED-0200 |  | SPINLUX (SL-A2IRXX10-24CL) IR Illuminator 10° Angle with 120 m approx. range |
|-----------|---|--|

| | | |
|-----------|---|---|
| PLED-0201 |  | SPINLUX (SL-A2IRXX25-24CL) IR Illuminator 25° Angle with 50 m approx. range |
|-----------|---|---|

| | | |
|-----------|--|---|
| PLED-0202 |  | SPINLUX (SL-A2IRXX35-24CL) IR Illuminator 35° Angle with 25 m approx. range |
|-----------|--|---|

Other Accessories - Camera Part

| | | |
|------------|---|--------------------------|
| R716-00001 |  | Sunshield (for B4x, I4x) |
|------------|---|--------------------------|

Product Demo - Camera Demo Kit

| | | |
|-----------|---|---|
| PCDK-0001 |  | Camera Demo Kit Rack Box (350 x 550 x 140 mm) for all cameras except Mini Domes |
|-----------|---|---|

Installation Support - Camera Installation Kit

| | | |
|---------------|---|--|
| PMON-1001-010 |  | Camera Installation Kit for use with iOS Device with belt bag, battery and charger (US, AC 110~240V) |
|---------------|---|--|

| | | |
|---------------|---|--|
| PMON-1001-011 |  | Camera Installation Kit for use with iOS Device with belt bag, battery and charger (Europe, AC 110~240V) |
|---------------|---|--|

| | | |
|-----------|---|-------------------------|
| PMON-2000 |  | Camera Installation Kit |
|-----------|---|-------------------------|