

B61

5MP with D/N, Adaptive IR, Basic WDR, 3x Zoom Lens



- 5 Megapixel
- Day & Night with Adaptive IR LED
- 3x Zoom Lens with f3.0-9mm/F1.2-F2.1, DC iris, Auto focus
- Basic WDR
- Wide Angle
- Event trigger, response and notification

► Specifications

Device

| | |
|--------------------------|---|
| Product Type | Zoom Dome |
| Maximum Resolution | 5MP |
| Application Environment | Indoor |
| Image Sensor | Progressive Scan CMOS |
| Sensor Size | 1/3.2 " |
| Effective Pixels | 2592(H) X 1944(V) (5.04 MP) |
| Day / Night | Yes |
| Low Light Sensitivity | Standard |
| Minimum Illumination | Color: 0.1 lux at F1.2 (30 IRE, 2400 K); B/W: 0 lux at F1.2 (IR LED on) |
| Color to B/W Switch | ISP based switch, configurable |
| Mechanical IR Cut Filter | Yes |
| IR Sensitivity Range | 700-1100nm |
| IR LED | Adaptive IR LED x 10 (850 nm) |
| IR Working Distance | 40m |
| Electronic Shutter | 1/5-1/2000 second (manual mode); 1/5-1/10000 second (auto mode) |

| | |
|----------------------------------|----------|
| Horizontal Resolution (TV Lines) | 1500 TVL |
| S/N Ratio | 52 dB |

Lens

| | |
|--------------------------|---|
| Focal Length | Zoom, f3.0-9mm |
| Aperture | F1.2-F2.1 |
| Zoom Ratio | 3x optical |
| Zoom Application | Camera Installation, Auto Zoom by Event, Manual Operation |
| Iris | DC iris |
| Focus | Auto focus |
| Lens Mount | Board mount |
| Horizontal Viewing Angle | 85.7° - 30.5° |
| Vertical Viewing Angle | 64.6° - 23.2° |
| Viewing Angle Adjustment | Pan: 0°-350°, Tilt: 5°-175°, Rotation: 0°-350° |

PTZ

| | |
|----------------------------|---|
| Pan, Tilt or Zoom protocol | Visca, Pelco-D, Pelco-P, ACTi URL command |
|----------------------------|---|

Video

| | |
|-----------------------------------|---|
| Compression | H.264 (Baseline/ Main/ High profile), MJPEG |
| Maximum Frame Rate vs. Resolution | 15 fps at 2592 x 1944 15 fps at 2048 x 1536 30 fps at 1920 x 1080 30 fps at 1280 x 720 30 fps at 800 x 600 30 fps at 640 x 480 15 fps at 320 x 240 |
| Multi-Streaming | Simultaneous dual streams based on two configurations |
| Bit Rate | 28Kbps - 6Mbps (per stream) |
| Bit Rate Mode | Constant, Variable |
| Wide Dynamic Range | Basic WDR (74 dB) |
| Image Enhancement | White Balance, Brightness, Contrast, Sharpness, Automatic gain control, Flickerless |
| Digital Noise Reduction | DNR |
| Privacy Mask | 4 configurable regions for each of 17 preset points |
| Text Overlay | Yes |
| On-Screen Graphics | Yes |
| Server-based Analytics | Object Line Counting, People Counting, Face Detection, Object Based Motion Detection, Tamper, Object Line Crossing Detection, Object Enter Area Detection, Missing Object Detection, Unattended Object Detection, Smoke Detection, Heat Map, Dwell Time, People Queue Detection, (Require PC-based or standalone IVS or ALPR Server. Contact ACTi support for recommendations on how to maximize analytical accuracy) |
| Image Orientation | Flip, Mirror |

Audio

| | |
|-------------------|--|
| Audio Type | 2-way, Line-in, Line-out |
| Audio Compression | 8 kHz, 16 bit encoding, Mono, PCM, G.711 |

Network

| | |
|----------------------------|---|
| Network Protocol & Service | IPv4/v6, TCP, UDP, DHCP, PPPoE, HTTP, HTTPS, DNS, DDNS, NTP, RTP, RTSP, RTCP, SMTP, FTP, IGMP, ICMP, ARP, Bonjour, UPnP, QoS, SNMP, IEEE 802.1X |
| Ethernet Port | 1 x RJ-45 connector |
| Security | IP address filtering, HTTPS encryption, Password protected user level, Anonymous login, IEEE 802.1X network access control |

Event

| | |
|----------------|--|
| Event Trigger | Video motion detection (3 regions), External device through digital input, Sound detection, |
| Event Response | Notify control center, Go to Zoom preset point or preset tour, Change camera settings, Command other devices, E-mail notification with snapshots, Push notification to mobile device, Save video to local storage, Upload video or snapshot to FTP server, Upload video to NVR server, Activate external device through digital output |

Integration

| | |
|--------------------------|---|
| Unified Solution | Fully compatible with ACTi software |
| Software Development Kit | Yes |
| GPS Position | Manual setting |
| ONVIF Compliant | Yes, Profile S, Profile G, Profile T, Profile Q |
| GB28181 Compliant | Yes |
| Web Browser | IE 11 |
| Auto Firmware Upgrade | Yes |

Interface

| | |
|----------------------|--|
| Audio Interface | Terminal block |
| Local Storage | MicroSDHC, MicroSDXC Memory Card Slot (card not included, up to 256GB) |
| Digital Input/Output | 2/2 |
| Operating Button | Reset Button |

General

| | |
|-----------------------|--|
| Power Source | DC 12V, PoE Class 3 (IEEE802.3af) |
| Power Consumption | 6.24 W (PoE) |
| Weight | 717g (1.581lb) |
| Dimensions | (Ø x H): 146mm x 107mm (5.7" x 4.2") |
| Environmental Casing | Vandal resistant (IK09) |
| Mount Type | Surface, Gang Box, Flush, Pendant, Converter for NPT Standard Mounts, Wall Mount, Pole Mount, Corner Mount |
| Starting Temperature | -10°C ~ 50°C (14°F ~ 122°F) |
| Operating Temperature | -10°C ~ 50°C (14°F ~ 122°F) |
| Operating Humidity | 10% - 85% RH |
| Approvals | CE, FCC, IK09, UL (for optional PoE injector and power adapter) |
| Real-time Clock (RTC) | Yes |
| Warranty | 3 Year(s). For extended warranty offering, see http://www.acti.com/support/warranty |

► Photo Indication





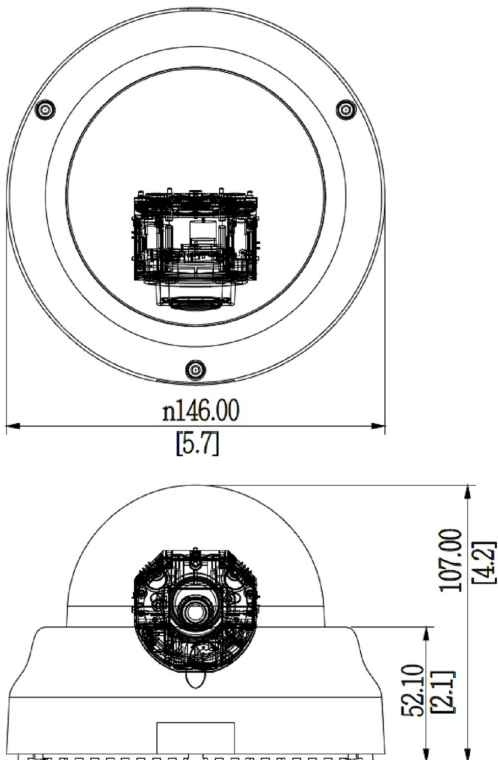













► Dimension Diagram



Unit: mm [inch]

► Related Products

Mounting Accessories - Camera Mount

| | | |
|-----------|--|--|
| PMAX-0101 |  | Mount Kit for all Dome Cameras (except Mini Domes) |
| PMAX-0102 |  | Straight Tube |
| PMAX-0103 |  | Straight Tube with Bracket |
| PMAX-0104 |  | Extension Tube |
| PMAX-0302 |  | Gooseneck with Bracket |
| PMAX-0303 |  | Gooseneck |
| PMAX-0305 |  | Heavy Duty Wall Mount |
| PMAX-0313 |  | Heavy Duty Wall Mount for Indoor Domes (for B5x, B6x, D6x, E6x, I5x) |
| PMAX-0402 |  | Corner Mount |
| PMAX-0503 |  | Pole Mount (for PMAx-0102, PMAx-0312, PMAx-0313, PMAx-0314, PMAx-0702, PMAx-1106, PMAx-1107), supports 5.25" to 8.5" Poles |
| PMAX-0505 |  | Pole Mount (for B4x, B41x, E44, E45, E46, E48, E44A, E45A, E46A, E41x, I4x, PMAx-0312, PMAx-0313, PMAx-0314, PMAx-0330), supports 2" to 3" Poles |
| PMAX-0702 |  | Junction Box for PTZ and Dome Cameras |
| PMAX-0804 |  | Gang Box Converter for Outdoor Domes, supports Two-Gang Boxes |
| PMAX-0807 |  | Gangbox Converter (for PMAx-0102, PMAx-0312, PMAx-0313, PMAx-0314, PMAx-0321), supports Two-Gang Boxes |
| PMAX-0808 |  | Converter Ring, 1.5" NPT for Third-Party Mounting Accessories |
| PMAX-1012 |  | Flush Mount Kit (for B6x) |

Note: Some mounting accessories may need additional accessories for installation. Please check www.acti.com/mountingselector for more information.

Dome Covers - Transparent Dome Cover

R701-70006



Transparent Dome Cover Only (for B51, B52, B53, B61~B67, B81~B87, B94~B97, D61~D65, D6xA, D7x, D7xA, D8x, D8xA, E61~E69, E6xA, E71~E77, E7xA, E81~E88, E8xA, Q61, Q81)

Dome Covers - Smoked Dome Cover

PDCX-1109



Vandal Proof Smoked Dome Cover for B6x, B8x, B9x

Dome Covers - Dome Cover Shroud

PDCX-1114



Dome Cover Shroud for B6x, B8x, Q61, Q81

Power Supply Accessories - Power Adapter

PPBX-0011



Power Adapter AC 100~240V, with universal connectors for all DC12V powered devices

Power Supply Accessories - PoE Injector

PPOE-0000



PoE Injector , IEEE 802.3af compliant, AC 100~240V, for US & Japan

PPOE-0001



PoE Injector IEEE 802.3af compliant, AC 100~240V, with universal connectors

Network & Storage Peripherals - Data Switch

PPSW-0100



PLANET FGSD-910HP 8-Port 802.3at PoE Switch (PoE Budget 120W)

PPSW-0101



PLANET GS-4210-8P2T2S 8-Port Gigabit 802.3at Managed PoE Switch (PoE Budget 240W)

PPSW-0102



PLANET FGSD-1011HP 8-Port 802.3at PoE Switch (PoE Budget 120W)

PPSW-1101



PLANET GS-4210-24PL4C 24-Port Gigabit 802.3at Managed PoE Switch (PoE Budget 440W)

PPSW-2101



4-Port 802.3at PoE Switch (PoE Budget 62W)

PPSW-3100



PLANET FGSW-1816HPS 16-Port 802.3at PoE Switch (PoE Budget 220W)

Extenders - PoE Extender

PPEX-0100



Veracity OUTREACH Max Power over Ethernet (PoE) Extender

Extenders - PoE over Coaxial Extender Kit

PPOC-0100



Planet LRP-101C-KIT Power over Coax Adapter Kit

Audio Devices - Microphone

PMIC-0100  Active Microphone Omnidirectional for all Cameras with Line-in Audio

Illuminators - IR LED Illuminator

PLED-0200  SPINLUX (SL-A2IRXX10-24CL) IR Illuminator 10° Angle with 120 m approx. range

PLED-0201  SPINLUX (SL-A2IRXX25-24CL) IR Illuminator 25° Angle with 50 m approx. range

PLED-0202  SPINLUX (SL-A2IRXX35-24CL) IR Illuminator 35° Angle with 25 m approx. range

Product Demo - Camera Demo Kit

PCDK-0001  Camera Demo Kit Rack Box (350 x 550 x 140 mm) for all cameras except Mini Domes

Installation Support - Camera Installation Kit

PMON-1001-010  Camera Installation Kit for use with iOS Device with belt bag, battery and charger (US, AC 110~240V)

PMON-1001-011  Camera Installation Kit for use with iOS Device with belt bag, battery and charger (Europe, AC 110~240V)

PMON-2000  Camera Installation Kit