

B912

5MP Outdoor Mini PTZ with D/N, Extreme WDR, SLLS, 10x Zoom Lens



- 5 Megapixel
- Day & Night with Superior Low Light Sensitivity
- 10x Zoom Lens with f4.7-47mm/F1.6-F3.0, DC iris, Auto focus
- Extreme WDR
- Pan & Tilt
- H.265 Compression
- Event trigger, response and notification

► Specifications

Device

Product Type	Mini PTZ
Maximum Resolution	5MP
Application Environment	Outdoor
Image Sensor	Progressive Scan CMOS
Sensor Size	1/2.9 "
Effective Pixels	3096(H) X 2202(V) (6.82 MP)
Day / Night	Yes
Low Light Sensitivity	Superior
Minimum Illumination	Color: 0.003 lux at F1.6; B/W: 0.002 lux at F1.6
Color to B/W Switch	ISP based switch
Mechanical IR Cut Filter	Yes
IR Sensitivity Range	700-1100nm
IR LED	No
Electronic Shutter	1/5-1/64000 second (manual mode); 1/5-1/64000 second (auto mode)
Horizontal Resolution (TV Lines)	1750 TVL

S/N Ratio	75 dB
-----------	-------

Lens

Focal Length	Zoom, f4.7-47mm
Aperture	F1.6-F3.0
Zoom Ratio	10x optical zoom
Zoom Application	Camera Installation, Manual Operation, Auto Zoom by Event
Iris	DC iris
Focus	Learning-based Auto Focus
Lens Mount	Board mount
Horizontal Viewing Angle	50.67° - 5.14°
Vertical Viewing Angle	39.23° - 3.86°

PTZ

Scan Panning / Tilting Speed	1.6° - 64°/second, 1.6° - 32°/second
Manual Panning / Tilting Speed	0.16° - 54.72°/second, 0.16° - 27.36°/second
Preset Panning / Tilting Speed	1.54° - 180°/second, 0.5° - 90°/second
Panning Range	-175°~175°
Tilting Range	0°~180° (with E-flip)
PTZ Control	Remote manual control, 10 preset tours, Auto scan
Preset Accuracy (Panning/Tilting)	1.5°/1.5°
Absolute Position	Yes
Pan, Tilt or Zoom protocol	Visca, Pelco-D, Pelco-P, ACTi URL command

Video

Compression	H.265, H.264 (Baseline/ Main/ High profile), MJPEG
Maximum Frame Rate vs. Resolution	30 fps at 2592 x 1944 30 fps at 2048 x 1536 30 fps at 1920 x 1080 30 fps at 1280 x 960 30 fps at 1280 x 720 30 fps at 800 x 600 30 fps at 640 x 480 30 fps at 320 x 240
Multi-Streaming	Simultaneous triple streams based on configurations of video resolution, compression format, and frame rate
Bit Rate	128Kbps - 12Mbps (per stream)
Bit Rate Mode	Constant, Variable
Wide Dynamic Range	Extreme WDR (120 dB)
Image Enhancement	White Balance, Brightness, Contrast, Saturation, Sharpness, Automatic gain control, Flickerless, Defogging
Digital Noise Reduction	2D + 3D DNR
Privacy Mask	4 configurable regions for each of 17 preset points
Text Overlay	Yes
Built-in Analytics	Object Based Motion Detection, Tampering Detection, Shock Detection

Server-based Analytics	Object Line Counting, People Counting, Face Detection, Object Based Motion Detection, Tamper, Object Line Crossing Detection, Object Enter Area Detection, Missing Object Detection, Unattended Object Detection, Smoke Detection, Heat Map, Dwell Time, Direction Detection, Automatic License Plate Recognition, People Queue Detection, (Require PC-based or standalone IVS or ALPR Server. Contact ACTi support for recommendations on how to maximize analytical accuracy)
Image Orientation	Flip, Mirror

Audio

Audio Type	2-way, Mic-in, Line-in, Line-out
Audio Compression	8 kHz, 16 bit encoding, Mono, PCM, G.711

Network

Network Protocol & Service	IPv4/v6, TCP, UDP, DHCP, PPPoE, HTTP, HTTPS, DNS, DDNS, NTP, RTP, RTSP, RTCP, SMTP, FTP, IGMP, ICMP, ARP, Bonjour, UPnP, QoS, SNMP, IEEE 802.1X
Ethernet Port	1 x RJ-45 connector
Security	IP address filtering, HTTPS encryption, Password protected user level, Anonymous login, IEEE 802.1X network access control, Standard IoT Security (anti-hacking, anti-malware)

Event

Event Trigger	Video motion detection (10 included and excluded polygonal regions), External device through digital input, Tampering detection, Shock Detection, Sound detection, Video streams loss, System log buffer overrun, Remove system log, Logon events (Login Failure, Login Success, Block an Account)
Event Response	Notify control center, Go to PTZ preset point or preset tour, Change camera settings, Command other devices, E-mail notification with snapshots, Push notification to mobile device, Save video to local storage, Upload video to NVR server, Upload video or snapshot to FTP server, Activate external device through digital output

System

System Monitor	CPU loading, memory usage and network statistics via API
System Log	Support
Watchdog	Support

Integration

Unified Solution	Fully compatible with ACTi software
GPS Position	Manual setting
Edge Recording	Support (integration with NVR by ONVIF Profile G or proprietary protocol)**
ONVIF Compliant	Yes, Profile S, Profile G, Profile T, Profile M
GB28181 Compliant	Yes
Web Browser	IE 11, Google Chrome*, Microsoft Edge*, Apple Safari*
Auto Firmware Upgrade	Yes

Interface

Local Storage	MicroSDHC, MicroSDXC Memory Card Slot (card not included, up to 256GB, Kingston or Sandisk only)
Digital Input/Output	1/1
Operating Button	Reset Button

General

Power Source	DC 12V, PoE Class 3 (IEEE802.3af)
Power Consumption	12 W (PoE)
Weight	1493g (3.292lb)
Dimensions	(Ø x H): 152.8mm x 131.0mm (6" x 5.2")
Environmental Casing	Weatherproof (IP67), Vandal proof (IK10)
Corrosion Protection	Optional for project request. Chassis corrosion resistance at the seashore approximately 10 years.
Mount Type	Surface, Wall Mount, Pendant, Flush, Corner Mount, Pole Mount, Gang Box
Heater	Yes
Starting Temperature	-30°C ~ 60°C (-22°F ~ 140°F) within 30 minutes
Operating Temperature	-40°C ~ 60°C (-40°F ~ 140°F)
Operating Humidity	10% - 85% RH
Approvals	CE (EN 55032 Class B, EN 55024), FCC Class B, EAC, IP67, IK10, NEMA 4X, UL (for optional PoE injector and power adapter)
Real-time Clock (RTC)	Yes
Warranty	3 Year(s) (3 months in continuous motion). For extended warranty offering, see http://www.acti.com/support/warranty

* cross-browser compatibility: Not available for H.265 video decoding and Intelligent Video settings ** Edge Recording function is integrated with NVR 3 Corporate / NVR 3 Business / INR / GNR series.

► Photo Indication



- 1 Ethernet Port
- 2 DC 12V Power Input
- 3 Audio Input / Output and Digital Input / Output
- 4 Reset Button
- 5 Memory Card Slot



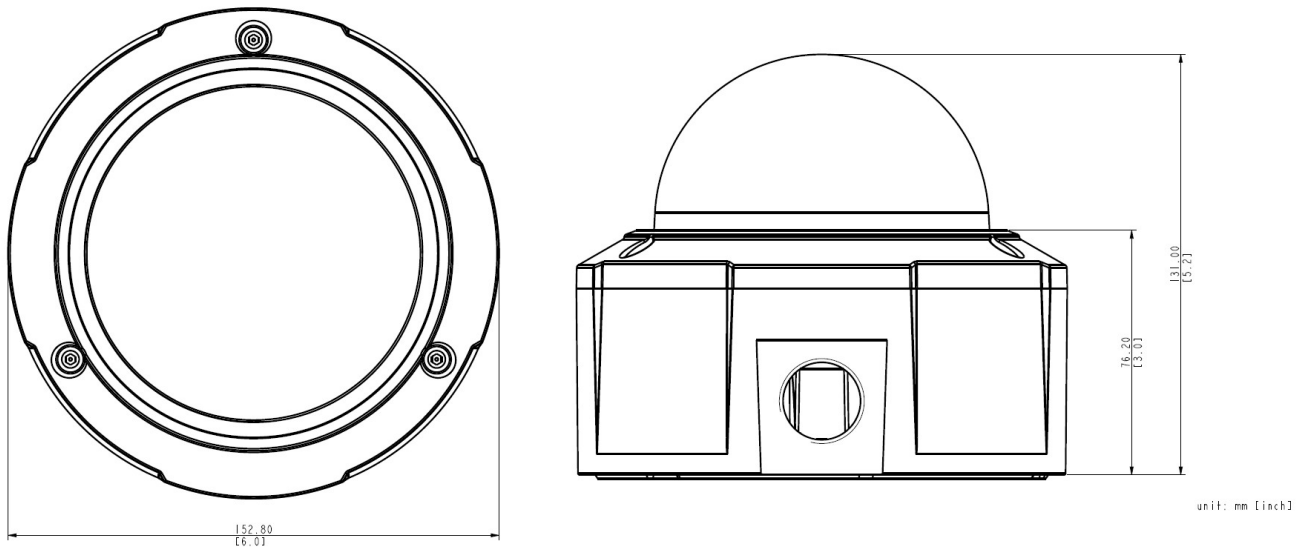













► Dimension Diagram



Unit: mm [inch]

► Related Products

Mounting Accessories - Camera Mount





PMAX-0101		Mount Kit for all Dome Cameras (except Mini Domes)
PMAX-0102		Straight Tube
PMAX-0103		Straight Tube with Bracket
PMAX-0104		Extension Tube
PMAX-0110		Mount Kit (for I91, I92, KCM-8111)
PMAX-0302		Gooseneck with Bracket
PMAX-0303		Gooseneck
PMAX-0354		Heavy Duty Wall Mount for A711, A713
PMAX-0402		Corner Mount
PMAX-0503		Pole Mount (for PMA-0102, PMA-0312, PMA-0313, PMA-0314, PMA-0702, PMA-1106, PMA-1107), supports 5.25" to 8.5" Poles
PMAX-0505		Pole Mount (for B4x, B41x, E44, E45, E46, E48, E44A, E45A, E46A, E41x, I4x, PMA-0312, PMA-0313, PMA-0314, PMA-0330), supports 2" to 3" Poles
PMAX-0702		Junction Box for PTZ and Dome Cameras
PMAX-0807		Gangbox Converter (for PMA-0102, PMA-0312, PMA-0313, PMA-0314, PMA-0321), supports Two-Gang Boxes
PMAX-0808		Converter Ring, 1.5" NPT for Third-Party Mounting Accessories
PMAX-1015		Flush Mount Kit (for B71, E89, E815~E817, E822)
PMAX-1501		Cable Gland for Outdoor Domes (except Hemispheric Domes)

Note: Some mounting accessories may need additional accessories for installation. Please check www.acti.com/mountingselector for more information.

Power Supply Accessories - Power Adapter

PPBX-0011		Power Adapter AC 100~240V, with universal connectors for all DC12V powered devices
-----------	---	--

Network & Storage Peripherals - Data Switch

PPSW-0102		PLANET FGSD-1011HP 8-Port 802.3at PoE Switch (PoE Budget 120W)
PPSW-0105		PLANET GS-4210-8P2C 8-Port Gigabit 802.3at Managed PoE Switch (PoE Budget 120W)
PPSW-1101		PLANET GS-4210-24PL4C 24-Port Gigabit 802.3at Managed PoE Switch (PoE Budget 440W)
PPSW-3100		PLANET FGSW-1816HPS 16-Port 802.3at PoE Switch (PoE Budget 220W)



Extenders - PoE Extender

PPEX-0100		Veracity OUTREACH Max Power over Ethernet (PoE) Extender
-----------	---	--

Extenders - PoE over Coaxial Extender Kit

PPOC-0100		Planet LRP-101C-KIT Power over Coax Adapter Kit
-----------	---	---

Audio Devices - Microphone

PMIC-0100		Active Microphone Omnidirectional for all Cameras with Line-in Audio
PMIC-0201		Passive Microphone Omnidirectional for all Cameras with Mic-In Audio using Cable Wire or Terminal Connector, 2m cable

Illuminators - IR LED Illuminator

PLED-0200		SPINLUX (SL-A2IRXX10-24CL) IR Illuminator 10° Angle with 120 m approx. range
PLED-0201		SPINLUX (SL-A2IRXX25-24CL) IR Illuminator 25° Angle with 50 m approx. range