

B922

5MP Outdoor Speed Dome with D/N, Extreme WDR, SLLS, 36x Zoom Lens



- 5 Megapixel
- Day & Night with Superior Low Light Sensitivity
- 36x Zoom Lens with f4.6-165.6mm/F1.55-F5.0, DC iris, Auto focus
- Extreme WDR
- Endless Pan & Tilt
- H.265 Compression
- Event trigger, response and notification

► Specifications

Device

Product Type	Speed Dome
Maximum Resolution	5MP
Application Environment	Outdoor
Image Sensor	Progressive Scan CMOS
Sensor Size	1/2.9 "
Effective Pixels	3096(H) X 2202(V) (6.82 MP)
Day / Night	Yes
Low Light Sensitivity	Superior
Minimum Illumination	Color: 0.1 lux at F1.55 (30 IRE , 2400 K); B/W: 0.05 lux at F1.55 (30 IRE, 2400 K)
Color to B/W Switch	ISP based switch, configurable
Mechanical IR Cut Filter	Yes
IR Sensitivity Range	700-1100nm
IR LED	No
Electronic Shutter	1/5-1/64000 second (manual mode); 1/5-1/64000 second (auto mode)
Horizontal Resolution (TV Lines)	1750 TVL
S/N Ratio	56 dB

Lens

Focal Length	Zoom, f4.6-165.6mm
Aperture	F1.55-F5.0
Zoom Ratio	36x optical
Zoom Application	Camera Installation, Manual Operation, Auto Zoom by Event
Iris	DC iris
Focus	Learning-based Auto Focus
Lens Mount	Board mount
Horizontal Viewing Angle	51.14° - 2.17°
Vertical Viewing Angle	39.62° - 1.62°

PTZ

Scan Panning / Tilting Speed	1.6° - 64°/second, 1.6° - 32°/second
Manual Panning / Tilting Speed	0.16° - 54.4°/second, 0.16° - 27.2°/second
Preset Panning / Tilting Speed	0.16° - 720°/second, 0.16° - 360°/second
Panning Range	360° endless
Tilting Range	-20°~200°
Absolute Position	Yes
Pan, Tilt or Zoom protocol	ACTi URL command

Video

Compression	H.265, H.264 (Baseline/ Main/ High profile), MJPEG
Maximum Frame Rate vs. Resolution	30 fps at 2592 x 1944 30 fps at 2048 x 1536 30 fps at 1920 x 1080 30 fps at 1280 x 960 30 fps at 1280 x 720 30 fps at 800 x 600 30 fps at 640 x 480 30 fps at 320 x 240
Multi-Streaming	Simultaneous triple streams based on three configurations
Bit Rate	128Kbps - 12Mbps (per stream)
Bit Rate Mode	Constant, Variable
Wide Dynamic Range	Extreme WDR (120 dB)
Image Enhancement	White Balance, Brightness, Contrast, Saturation, Sharpness, Automatic gain control, Flickerless, Digital Image Stabilizer (DIS, EIS)(*), Defogging
Digital Noise Reduction	2D + 3D DNR
Privacy Mask	32 configurable 3D privacy masks (To be available through future firmware upgrade)
Text Overlay	Yes
Built-in Analytics	Object Based Motion Detection, Tampering Detection, Shock Detection
Image Orientation	Flip, Mirror

Audio

Audio Type	2-way, Line-in, Line-out
------------	--------------------------

Network

Network Protocol & Service	IPv4/v6, TCP, UDP, DHCP, PPPoE, HTTP, HTTPS, DNS, DDNS, NTP, RTP, RTSP, RTCP, SMTP, FTP, IGMP, ICMP, ARP, Bonjour, UPnP, QoS, SNMP, IEEE 802.1X
Ethernet Port	1 x Ethernet (10/100 Base-T), RJ-45 pigtail connector

Security	IP address filtering, HTTPS encryption, Password protected user level, Anonymous login, IEEE 802.1X network access control
----------	--

Event

Event Trigger	Video motion detection (10 included and excluded polygons regions) External device through digital input Sound detection
Event Response	Notify control center, Go to PTZ preset point or preset tour, Change camera settings, Command other devices, Execute system command to activate other programs, Push notification to mobile device, Save video to local storage, Upload video or snapshot to FTP server, Activate external device through digital output

Integration

GPS Position	Manual setting
ONVIF Compliant	Yes, Profile S, Profile G, Profile T, Profile Q
GB28181 Compliant	Yes
Web Browser	IE 11
Auto Firmware Upgrade	Yes

Interface

Local Storage	MicroSDHC, MicroSDXC memory card slot (card not included)
Digital Input/Output	4/2 (Cable with Terminal block)

General

Power Source	AC 24V, High PoE (IEEE802.3at)
Power Consumption	52 W (PoE, heater and fan on), 62 W (AC, heater and fan on)
Weight	2751g (6.065lb)
Environmental Casing	Weatherproof (IP67), Vandal proof (IK10), Built-in dehumidifier
Bundled Accessories	High PoE injector (for USA) or Power Adapter (for other countries)
Mount Type	Wall Mount, Pendant, Flush, Corner Mount, Pole Mount, Gang Box
Fan	Yes
Heater	Yes
Dehumidifier	Yes
Starting Temperature	-40°C ~ 50°C (-40°F ~ 122°F) within 30 minutes
Operating Temperature	-40°C ~ 50°C (-40°F ~ 122°F)
Operating Humidity	10% - 85% RH
Approvals	CE, FCC, IP67, NEMA 4X, IK10, UL (for bundled power adapter)
Warranty	3 Year(s) (1 year in continuous motion). For extended warranty offering, see http://www.acti.com/support/warranty

* To be available through future firmware upgrade

▶ Photo Indication

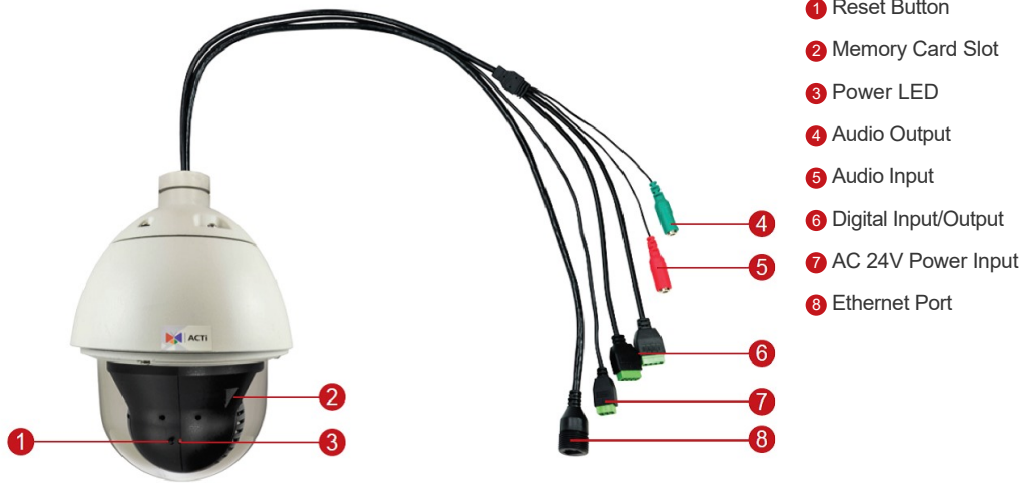

▶ Dimension Diagram

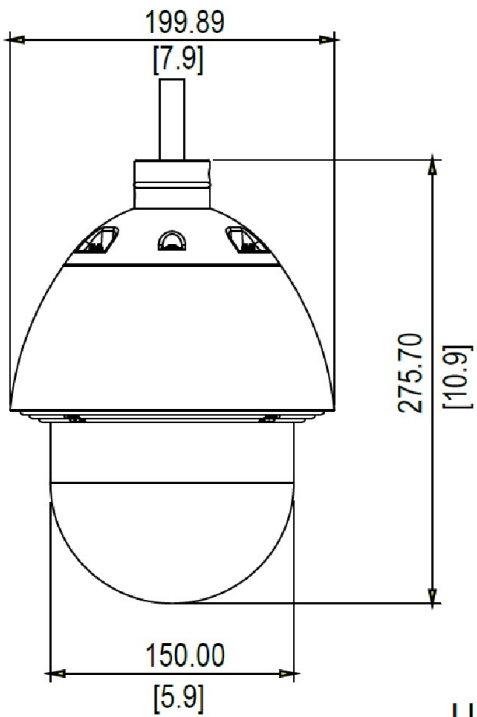













Unit: mm [inch]

Unit: mm [inch]

▶ Related Products

Mounting Accessories - Camera Mount

PMAX-0102		Straight Tube
PMAX-0103		Straight Tube with Bracket
PMAX-0104		Extension Tube
PMAX-0108		Straight Tube (for TCM-6630)
PMAX-0302		Gooseneck with Bracket
PMAX-0303		Gooseneck
PMAX-0312		PTZ Wall Mount for Outdoor PTZ / Speed Dome (except KCM-8211 & TCM-6630)
PMAX-0402		Corner Mount
PMAX-0503		Pole Mount (for PMA-0102, PMA-0312, PMA-0313, PMA-0314, PMA-0702, PMA-1106, PMA-1107), supports 5.25" to 8.5" Poles
PMAX-0505		Pole Mount (for B4x, B41x, E44, E45, E46, E48, E44A, E45A, E46A, E41x, I4x, PMA-0312, PMA-0313, PMA-0314, PMA-0330), supports 2" to 3" Poles
PMAX-0702		Junction Box for PTZ and Dome Cameras
PMAX-0807		Gangbox Converter (for PMA-0102, PMA-0312, PMA-0313, PMA-0314, PMA-0321), supports Two-Gang Boxes
PMAX-0808		Converter Ring, 1.5" NPT for Third-Party Mounting Accessories

Note: Some mounting accessories may need additional accessories for installation. Please check www.acti.com/mountingselector for more information.

Dome Covers - Smoked Dome Cover

PDCX-1108		Vandal Proof Smoked Dome Cover for I93~I97, I99, I910, B916, B917, B922, B943
-----------	---	---

Extenders - PoE Extender

PPEX-0100		Veracity OUTREACH Max Power over Ethernet (PoE) Extender
-----------	---	--

Extenders - PoE over Coaxial Extender Kit

PPOC-0100		Planet LRP-101C-KIT Power over Coax Adapter Kit
-----------	---	---

Audio Devices - Microphone

PMIC-0100



Active Microphone Omnidirectional for all Cameras with Line-in Audio

Illuminators - IR LED Illuminator

PLED-0200



SPINLUX (SL-A2IRXX10-24CL) IR Illuminator 10° Angle with 120 m approx. range

PLED-0201



SPINLUX (SL-A2IRXX25-24CL) IR Illuminator 25° Angle with 50 m approx. range

PLED-0204



SPINLUX (SL-A2IRXX25-48CL) IR Illuminator 25° Angle with 80 m approx. range

PLED-0205



SPINLUX (SL-A2IRXX35-48CL) IR Illuminator 35° Angle with 40 m approx. range

Installation Support - Camera Installation Kit

PMON-2000



Camera Installation Kit