

# B928

## 5MP Outdoor Speed Dome with D/N, Adaptive IR, Extreme WDR, SLLS, 36x Zoom Lens



- 5 Megapixel
- Day & Night with Superior Low Light Sensitivity and Adaptive IR LED
- 36x Zoom Lens with f4.6-165.6mm/F1.55-F5.0, DC iris, Auto focus
- Extreme WDR
- Endless Pan & Tilt
- H.265 Compression
- Taiwan IoT Cybersecurity Certification Level 1 (TAICS)
- Event trigger, response and notification

### ► Specifications

#### Device

|                          |                                                                  |
|--------------------------|------------------------------------------------------------------|
| Product Type             | Speed Dome                                                       |
| Maximum Resolution       | 5MP                                                              |
| Application Environment  | Outdoor                                                          |
| Image Sensor             | Progressive Scan CMOS                                            |
| Sensor Size              | 1/2.9 "                                                          |
| Effective Pixels         | 3096(H) X 2202(V) (6.82 MP)                                      |
| Day / Night              | Yes                                                              |
| Low Light Sensitivity    | Superior                                                         |
| Minimum Illumination     | Color: 0.003 lux at F1.55; B/W: 0 lux (IR LED on)                |
| Color to B/W Switch      | ISP based switch, configurable                                   |
| Mechanical IR Cut Filter | Yes                                                              |
| IR Sensitivity Range     | 700-1100nm                                                       |
| IR LED                   | Adaptive IR LED x 6 (850 nm)                                     |
| IR Working Distance      | 200m                                                             |
| Electronic Shutter       | 1/5-1/64000 second (manual mode); 1/5-1/64000 second (auto mode) |

|                                  |          |
|----------------------------------|----------|
| Horizontal Resolution (TV Lines) | 1750 TVL |
| S/N Ratio                        | 75 dB    |

### Lens

|                          |                                                           |
|--------------------------|-----------------------------------------------------------|
| Focal Length             | Zoom, f4.6-165.6mm                                        |
| Aperture                 | F1.55-F5.0                                                |
| Zoom Ratio               | 36x optical zoom                                          |
| Zoom Speed               | 2 second (wide to tele)                                   |
| Zoom Application         | Camera Installation, Auto Zoom by Event, Manual Operation |
| Iris                     | DC iris                                                   |
| Focus                    | Learning-based Auto Focus                                 |
| Lens Mount               | Board mount                                               |
| Horizontal Viewing Angle | 51.14° - 2.17°                                            |
| Vertical Viewing Angle   | 39.62° - 1.62°                                            |

### PTZ

|                                   |                                                                      |
|-----------------------------------|----------------------------------------------------------------------|
| Scan Panning / Tilting Speed      | 1.6° - 64°/second, 1.6° - 32°/second                                 |
| Manual Panning / Tilting Speed    | 0.16° - 54.4°/second, 0.16° - 27.2°/second                           |
| Preset Panning / Tilting Speed    | 0.16° - 300°/second, 0.16° - 150°/second                             |
| Panning Range                     | 360° endless                                                         |
| Tilting Range                     | -20°~200°                                                            |
| PTZ Control                       | Remote manual control, 256 preset points, 10 preset tours, Auto scan |
| Preset Accuracy (Panning/Tilting) | ±0.265°/±0.265°                                                      |
| Absolute Position                 | Yes                                                                  |
| Pan, Tilt or Zoom protocol        | Visca, Pelco-D, Pelco-P, ACTi URL command                            |

### Video

|                                   |                                                                                                                                                                         |
|-----------------------------------|-------------------------------------------------------------------------------------------------------------------------------------------------------------------------|
| Compression                       | H.265, H.264 (Baseline/ Main/ High profile), MJPEG                                                                                                                      |
| Maximum Frame Rate vs. Resolution | 30 fps at 2592 x 1944 30 fps at 2048 x 1536 30 fps at 1920 x 1080 30 fps at 1280 x 960 30 fps at 1280 x 720 30 fps at 800 x 600 30 fps at 640 x 480 30 fps at 320 x 240 |
| Multi-Streaming                   | Simultaneous triple streams based on configurations of video resolution, compression format, and frame rate                                                             |
| Bit Rate                          | 128Kbps - 12Mbps (per stream)                                                                                                                                           |
| Bit Rate Mode                     | Constant, Variable                                                                                                                                                      |
| Wide Dynamic Range                | Extreme WDR (120 dB)                                                                                                                                                    |
| Image Enhancement                 | White Balance, Brightness, Contrast, Saturation, Sharpness, Automatic gain control, Flickerless, Defogging                                                              |
| Digital Noise Reduction           | 2D + 3D DNR                                                                                                                                                             |
| Privacy Mask                      | 4 configurable regions for each of 17 preset points                                                                                                                     |

|                        |                                                                                                                                                                                                                                                                                                                                                                                                                                                                                 |
|------------------------|---------------------------------------------------------------------------------------------------------------------------------------------------------------------------------------------------------------------------------------------------------------------------------------------------------------------------------------------------------------------------------------------------------------------------------------------------------------------------------|
| Text Overlay           | Yes                                                                                                                                                                                                                                                                                                                                                                                                                                                                             |
| Built-in Analytics     | Object Based Motion Detection, Tampering Detection, Shock Detection                                                                                                                                                                                                                                                                                                                                                                                                             |
| Server-based Analytics | Object Line Counting, People Counting, Face Detection, Object Based Motion Detection, Tamper, Object Line Crossing Detection, Object Enter Area Detection, Missing Object Detection, Unattended Object Detection, Smoke Detection, Heat Map, Dwell Time, Direction Detection, Automatic License Plate Recognition, People Queue Detection, (Require PC-based or standalone IVS or ALPR Server. Contact ACTi support for recommendations on how to maximize analytical accuracy) |
| Image Orientation      | Flip, Mirror                                                                                                                                                                                                                                                                                                                                                                                                                                                                    |

## Audio

|                   |                                          |
|-------------------|------------------------------------------|
| Audio Type        | 2-way, Line-in, Line-out                 |
| Audio Compression | 8 kHz, 16 bit encoding, Mono, PCM, G.711 |

## Network

|                            |                                                                                                                                                                                |
|----------------------------|--------------------------------------------------------------------------------------------------------------------------------------------------------------------------------|
| Network Protocol & Service | IPv4/v6, TCP, UDP, DHCP, PPPoE, HTTP, HTTPS, DNS, DDNS, NTP, RTP, RTSP, RTCP, SMTP, FTP, IGMP, ICMP, ARP, Bonjour, UPnP, QoS, SNMP, IEEE 802.1X                                |
| Ethernet Port              | 1 x RJ-45 pigtail connector                                                                                                                                                    |
| Security                   | IP address filtering, HTTPS encryption, Password protected user level, Anonymous login, IEEE 802.1X network access control, Standard IoT Security (anti-hacking, anti-malware) |

## Event

|                |                                                                                                                                                                                                                                                                                                           |
|----------------|-----------------------------------------------------------------------------------------------------------------------------------------------------------------------------------------------------------------------------------------------------------------------------------------------------------|
| Event Trigger  | Video motion detection (10 included and excluded polygonal regions), External device through digital input, Tampering detection, Shock Detection, Sound detection, Video streams loss, System log buffer overrun, Remove system log, Logon events (Login Failure, Login Success, Block an Account)        |
| Event Response | Notify control center, Go to PTZ preset point or preset tour, Change camera settings, Command other devices, E-mail notification with snapshots, Push notification to mobile device, Save video to local storage, Upload video or snapshot to FTP server, Activate external device through digital output |

## System

|                |                                                          |
|----------------|----------------------------------------------------------|
| System Monitor | CPU loading, memory usage and network statistics via API |
| System Log     | Support                                                  |
| Watchdog       | Support                                                  |

## Integration

|                          |                                                                             |
|--------------------------|-----------------------------------------------------------------------------|
| Unified Solution         | Fully compatible with ACTi software                                         |
| Software Development Kit | Yes                                                                         |
| GPS Position             | Manual setting                                                              |
| Edge Recording           | Support (integration with NVR by ONVIF Profile G or proprietary protocol)** |
| ONVIF Compliant          | Yes, Profile S, Profile G, Profile T, Profile M                             |
| GB28181 Compliant        | Yes                                                                         |
| Web Browser              | IE 11, Google Chrome*, Microsoft Edge*, Apple Safari*                       |
| Auto Firmware Upgrade    | Yes                                                                         |

**Interface**

|                      |                                                                                                  |
|----------------------|--------------------------------------------------------------------------------------------------|
| Audio Interface      | 1/1, Cable with 3.5mm Phone Jack                                                                 |
| Local Storage        | MicroSDHC, MicroSDXC Memory Card Slot (card not included, up to 256GB, Kingston or Sandisk only) |
| Digital Input/Output | 4/2 (Cable with Terminal block)                                                                  |
| Operating Button     | Reset Button                                                                                     |

**General**

|                       |                                                                                                                                                                      |
|-----------------------|----------------------------------------------------------------------------------------------------------------------------------------------------------------------|
| Power Source          | AC 24V, High PoE 75W                                                                                                                                                 |
| Power Consumption     | 56 W (PoE, heater and fan on), 62 W (AC, heater and fan on)                                                                                                          |
| Weight                | 3146g (6.936lb)                                                                                                                                                      |
| Dimensions            | (Ø x H): Outdoor: 170mm x 260mm (6.69" x 10.24")                                                                                                                     |
| Environmental Casing  | Weatherproof (IP66), Vandal proof metal casing (IK10), Built-in dehumidifier, Scratch-resistant and water-repellent lens glass                                       |
| Corrosion Protection  | Optional for project request. Chassis corrosion resistance at the seashore approximately 10 years.                                                                   |
| Bundled Accessories   | High PoE injector (for USA) or Power Adapter (for other countries)                                                                                                   |
| Mount Type            | Wall Mount, Pendant, Corner Mount, Pole Mount, Gang Box                                                                                                              |
| Fan                   | Yes                                                                                                                                                                  |
| Heater                | Yes                                                                                                                                                                  |
| Dehumidifier          | Yes                                                                                                                                                                  |
| Starting Temperature  | -40°C ~ 55°C (-40°F ~ 131°F) within 30 minutes                                                                                                                       |
| Operating Temperature | -40°C ~ 55°C (-40°F ~ 131°F)                                                                                                                                         |
| Operating Humidity    | 10% - 85% RH                                                                                                                                                         |
| Approvals             | CE Class B, FCC Class B, EAC, IP66, NEMA 4X, IK10 (metal casing), Taiwan IoT Cybersecurity Certification Level 1 (TAICS)                                             |
| Material              | Housing Material: Metal                                                                                                                                              |
| Real-time Clock (RTC) | Yes                                                                                                                                                                  |
| Warranty              | 3 Year(s) (1 year in continuous motion). For extended warranty offering, see <a href="http://www.acti.com/support/warranty">http://www.acti.com/support/warranty</a> |

\* cross-browser compatibility: Not available for H.265 video decoding and Intelligent Video settings \*\* Edge Recording function is integrated with NVR 3 Corporate / NVR 3 Business / INR / GNR series.

► Photo Indication



- 1 Power LED
- 2 Reset Button
- 3 Memory Card Slot
- 4 Audio Output
- 5 Audio Input
- 6 Digital Input/Output
- 7 AC 24V Power Input
- 8 Ethernet Port

► Dimension Diagram

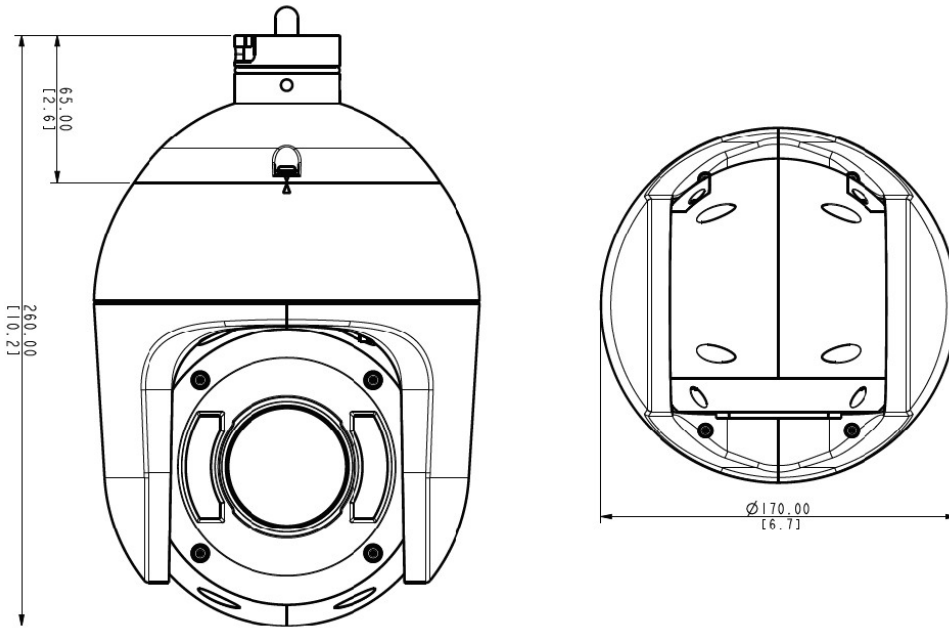













Unit: mm [inch]

Unit: mm [inch]



## ► Related Products

### Mounting Accessories - Camera Mount

|           |                                                                                                                                              |                                                                                                                                                  |
|-----------|----------------------------------------------------------------------------------------------------------------------------------------------|--------------------------------------------------------------------------------------------------------------------------------------------------|
| PMAX-0102 |                                                             | Straight Tube                                                                                                                                    |
| PMAX-0103 |                                                             | Straight Tube with Bracket                                                                                                                       |
| PMAX-0104 |                                                             | Extension Tube                                                                                                                                   |
| PMAX-0302 |                                                             | Gooseneck with Bracket                                                                                                                           |
| PMAX-0303 |                                                             | Gooseneck                                                                                                                                        |
| PMAX-0312 |                                                             | PTZ Wall Mount for Outdoor PTZ / Speed Dome (except KCM-8211 & TCM-6630)                                                                         |
| PMAX-0402 |                                                             | Corner Mount                                                                                                                                     |
| PMAX-0503 |                                    | Pole Mount (for PMAX-0102, PMAX-0312, PMAX-0313, PMAX-0314, PMAX-0702, PMAX-1106, PMAX-1107), supports 5.25" to 8.5" Poles                       |
| PMAX-0505 |                                     | Pole Mount (for B4x, B41x, E44, E45, E46, E48, E44A, E45A, E46A, E41x, I4x, PMAX-0312, PMAX-0313, PMAX-0314, PMAX-0330), supports 2" to 3" Poles |
| PMAX-0702 |                                                           | Junction Box for PTZ and Dome Cameras                                                                                                            |
| PMAX-0807 |                                                           | Gangbox Converter (for PMAX-0102, PMAX-0312, PMAX-0313, PMAX-0314, PMAX-0321), supports Two-Gang Boxes                                           |
| PMAX-0808 |  | Converter Ring, 1.5" NPT for Third-Party Mounting Accessories                                                                                    |

**Note:** Some mounting accessories may need additional accessories for installation. Please check [www.acti.com/mountingselector](http://www.acti.com/mountingselector) for more information.

### Power Supply Accessories - PoE Injector

|           |                                                                                     |                                                                                                                                                                                              |
|-----------|-------------------------------------------------------------------------------------|----------------------------------------------------------------------------------------------------------------------------------------------------------------------------------------------|
| PPOE-0103 |  | High PoE Injector, Single-port, 60W Gigabit Midspan, 4-Pairs, 802.3at Compliant, AC 100~240V, with universal connectors (for, I93~I910, I915, B915~B917, B922, B928, B945, B949, A950, A951) |
| PPOE-0104 |  | High PoE Injector, Single-port, 10/100/1000Mbps 60W, 4-Pairs, 802.3at Compliant, AC 100~240V, with universal connectors (for, I93~I910, I915, B915~B917, B922, B928, B945, B949, A950, A951) |

### Network & Storage Peripherals - Data Switch

|           |                                                                                     |                                                                                 |
|-----------|-------------------------------------------------------------------------------------|---------------------------------------------------------------------------------|
| PPSW-0105 |  | PLANET GS-4210-8P2C 8-Port Gigabit 802.3at Managed PoE Switch (PoE Budget 120W) |
|-----------|-------------------------------------------------------------------------------------|---------------------------------------------------------------------------------|

### Extenders - PoE Extender

PPEX-0100



Veracity OUTREACH Max Power over Ethernet (PoE) Extender

### Extenders - PoE over Coaxial Extender Kit

PPOC-0100



Planet LRP-101C-KIT Power over Coax Adapter Kit

### Audio Devices - Microphone

PMIC-0100



Active Microphone Omnidirectional for all Cameras with Line-in Audio

### Illuminators - IR LED Illuminator

PLED-0200



SPINLUX (SL-A2IRXX10-24CL) IR Illuminator 10° Angle with 120 m approx. range

PLED-0201



SPINLUX (SL-A2IRXX25-24CL) IR Illuminator 25° Angle with 50 m approx. range