

B934

2MP Indoor Speed Dome with D/N, Extreme WDR, SLLS, 30x Zoom Lens



- 2 Megapixel
- Day & Night with Superior Low Light Sensitivity
- 30x Zoom Lens with f4.5-135mm/F1.6-F4.4, DC iris, Auto focus
- Extreme WDR
- Event trigger, response and notification

► Specifications

Device

Product Type	Speed Dome
Maximum Resolution	2MP
Application Environment	Indoor
Image Sensor	Progressive Scan CMOS
Sensor Size	1/2.8 "
Effective Pixels	1945(H) X 1097(V) (2.13 MP)
Day / Night	Yes
Low Light Sensitivity	Superior
Minimum Illumination	Color: 0.002 lux at F1.6 (30 IRE); B/W: 0.001 lux (IR LED on)
Color to B/W Switch	ISP based switch, configurable
Mechanical IR Cut Filter	Yes
IR Sensitivity Range	700-1100nm
IR LED	No
Electronic Shutter	1/5-1/32000 second (manual mode); 1/5-1/32000 second (auto mode)
Horizontal Resolution (TV Lines)	1450 TVL

S/N Ratio	75 dB
-----------	-------

Lens

Focal Length	Zoom, f4.5-135mm
Aperture	F1.6-F4.4
Zoom Ratio	30x optical zoom, 16x digital zoom
Zoom Speed	2.4 second (wide to tele)
Zoom Application	Camera Installation, Auto Zoom by Event, Manual Operation
Iris	DC iris
Focus	Auto focus
Lens Mount	Board mount
Horizontal Viewing Angle	62.4° - 3.5°
Vertical Viewing Angle	37.6° - 2°

PTZ

Scan Panning / Tilting Speed	0.16° - 32°/second, 0.16° - 16°/second
Manual Panning / Tilting Speed	0.16° - 54.4°/second, 0.16° - 27.2°/second
Preset Panning / Tilting Speed	0.16° - 720°/second, 0.16° - 360°/second
Panning Range	360° endless
Tilting Range	0°~180°
PTZ Control	Remote manual control, 256 preset points, 10 preset tours, Auto scan
Preset Accuracy (Panning/Tilting)	±0.265°/±0.265°
Absolute Position	Yes
Pan, Tilt or Zoom protocol	Visca, Pelco-D, Pelco-P, ACTi URL command

Video

Compression	H.264 (Baseline/ Main/ High profile), MJPEG
Maximum Frame Rate vs. Resolution	60 fps at 1920 x 1080 60 fps at 1280 x 720 30 fps at 640 x 480 30 fps at 320 x 240
High Frame Mode	Support
Multi-Streaming	Simultaneous triple streams based on configurations of video resolution, compression format, and frame rate
Bit Rate	128Kbps - 12Mbps (per stream)
Bit Rate Mode	Constant, Variable
Wide Dynamic Range	Extreme WDR (145 dB)
Image Enhancement	White Balance, Brightness, Contrast, Sharpness, Automatic gain control, Flickerless, Digital Image Stabilizer (DIS, EIS), Defogging
Digital Noise Reduction	2D + 3D DNR
Privacy Mask	20 configurable 3D privacy masks
Text Overlay	Yes

Built-in Analytics	Basic Face Detection, Object Based Motion Detection, Tampering Detection, Shock Detection, PTZ Auto Tracking, Object Line Crossing Detection, Object Enter Area Detection, Missing Object Detection, Unattended Object Detection, Object Loitering Detection
Server-based Analytics	Object Line Counting, People Counting, Face Detection, Object Based Motion Detection, Tamper, Object Line Crossing Detection, Object Enter Area Detection, Missing Object Detection, Unattended Object Detection, Smoke Detection, Heat Map, Dwell Time, People Queue Detection, (Require PC-based or standalone IVS or ALPR Server. Contact ACTi support for recommendations on how to maximize analytical accuracy)
Image Orientation	Mirror, Flip
IVS performance	Certain algorithms may require more computing power, which may limit the number of algorithms that can be concurrently used in the camera. Please test the actual performance before using in a project.

Audio

Audio Type	2-way, Mic-in, Line-in, Line-out
Audio Compression	8 kHz, 16 bit encoding, Mono, PCM, G.711

Network

Network Protocol & Service	IPv4/v6, TCP, UDP, DHCP, PPPoE, HTTP, HTTPS, DNS, DDNS, NTP, RTP, RTSP, RTCP, SMTP, FTP, IGMP, ICMP, ARP, Bonjour, UPnP, QoS, SNMP, IEEE 802.1X
Ethernet Port	1 x RJ-45 connector
Security	IP address filtering, HTTPS encryption, Password protected user level, Anonymous login, IEEE 802.1X network access control, Standard IoT Security (anti-hacking, anti-malware)

Video Analytics

Analysis Source Type	Video
Metadata Accuracy	Standard

Event

Event Trigger	Video motion detection (10 included and excluded polygonal regions), External device through digital input, Sound detection, Intelligent event detection, Video streams loss, System log buffer overrun, Remove system log, Logon events (Login Failure, Login Success, Block an Account)
Event Response	Notify control center, Go to PTZ preset point or preset tour, Change camera settings, Command other devices, E-mail notification with snapshots, Push notification to mobile device, Save video to local storage, Upload video or snapshot to FTP server, Activate external device through digital output, Upload video to NVR server

System

System Monitor	CPU loading, memory usage and network statistics via API
System Log	Support
Watchdog	Support

Integration

Unified Solution	Fully compatible with ACTi software
Software Development Kit	Yes
GPS Position	Manual setting
Edge Recording	Support (integration with NVR by ONVIF Profile G or proprietary protocol)**

ONVIF Compliant	Yes, Profile S, Profile G, Profile T, Profile Q, Profile M* (To be available through future firmware upgrade)
GB28181 Compliant	Yes
Web Browser	IE 11, Google Chrome, Microsoft Edge, Apple Safari
Auto Firmware Upgrade	Yes

Interface

Audio Interface	1/1, 3.5mm Phone Jack
Local Storage	MicroSDHC, MicroSDXC Memory Card Slot (card not included, up to 256GB, Kingston or Sandisk only)
Digital Input/Output	2/2 (Terminal block)
Operating Button	Reset Button

General

Power Source	DC 12V, High PoE (IEEE802.3at)
Power Consumption	10.8 W (DC), 25.5 W (PoE)
Weight	1574g (3.47lb)
Dimensions	(Ø x H): 150mm x 170mm (5.9" x 6.7")
Environmental Casing	Vandal resistant (IK09)
Bundled Accessories	Surface mount, Power Adapter
Mount Type	Surface, Gang Box, Pendant, Converter for NPT Standard Mounts, Flush, Wall Mount, Pole Mount, Corner Mount
Starting Temperature	-10°C ~ 50°C (14°F ~ 122°F) within 30 minutes
Operating Temperature	-20°C ~ 50°C (-4°F ~ 122°F)
Operating Humidity	10% - 85% RH
Approvals	Camera: CE Class B, FCC Class B, IK09, Adapter: CE, FCC, UL, PSE, Efficiency Level V
Real-time Clock (RTC)	Yes
Warranty	3 Year(s) (1 year in continuous motion). For extended warranty offering, see http://www.acti.com/support/warranty

** Edge Recording function is integrated with NVR 3 Corporate / NVR 3 Business / INR / GNR series.

► Photo Indication

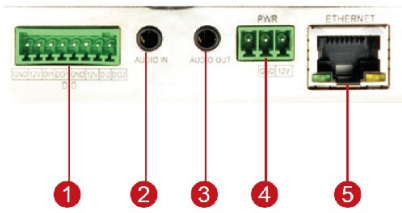

- 1 Digital Input/Output
- 2 Audio-In
- 3 Audio-Out
- 4 DC 12V Power Input
- 5 Ethernet Port
- 6 Memory Card Slot
- 7 Reset Button
- 8 Power LED



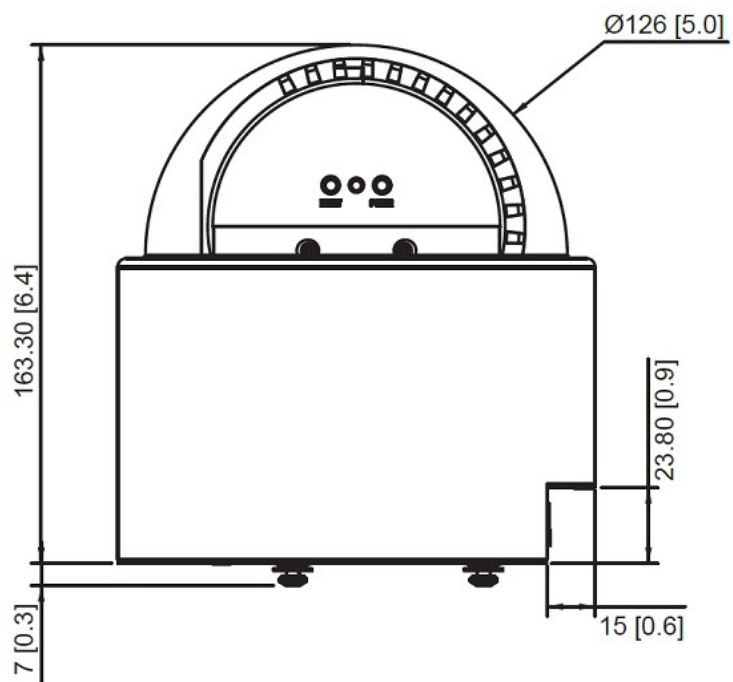
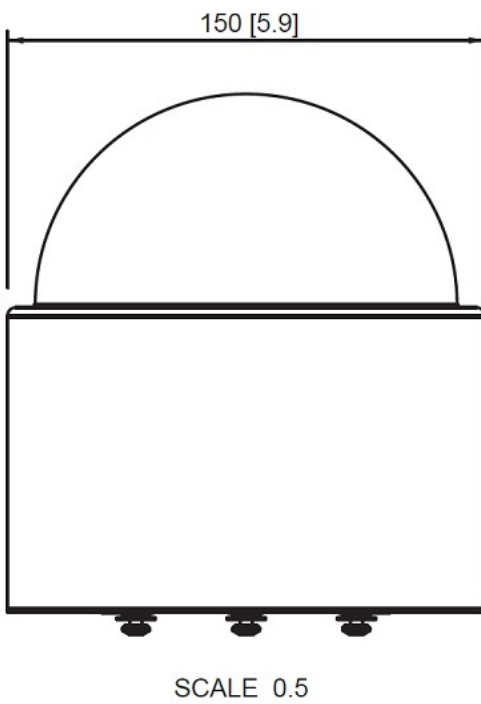









► Dimension Diagram



Unit: mm [inch]

► Related Products

Mounting Accessories - Camera Mount

PMAX-0102		Straight Tube
PMAX-0103		Straight Tube with Bracket
PMAX-0104		Extension Tube
PMAX-0110		Mount Kit (for I91, I92, KCM-8111)
PMAX-0302		Gooseneck with Bracket
PMAX-0303		Gooseneck
PMAX-0311		L-Type Wall Mount (for I91, I92, KCM-8111)
PMAX-0402		Corner Mount
PMAX-0503		Pole Mount (for PMA-0102, PMA-0312, PMA-0313, PMA-0314, PMA-0702, PMA-1106, PMA-1107), supports 5.25" to 8.5" Poles
PMAX-0702		Junction Box for PTZ and Dome Cameras
PMAX-0807		Gangbox Converter (for PMA-0102, PMA-0312, PMA-0313, PMA-0314, PMA-0321), supports Two-Gang Boxes
PMAX-0808		Converter Ring, 1.5" NPT for Third-Party Mounting Accessories
PMAX-1010		Flush Mount Kit (for I91, I92, KCM-8111)

Note: Some mounting accessories may need additional accessories for installation. Please check www.acti.com/mountingselector for more information.

Enclosures - PTZ Camera Housing

PMAX-0224		PTZ Explosion Proof Housing, SUS316 (for I92, B913, B923, B934)
-----------	---	---

Dome Covers - Smoked Dome Cover

PDCX-1105		Smoked Dome Cover for I91, I92, I912, B913, B923, B934, KCM-8111
-----------	---	--

Power Supply Accessories - Power Adapter

PPBX-0011  Power Adapter AC 100~240V, with universal connectors for all DC12V powered devices

Power Supply Accessories - PoE Injector

PPOE-0101  High PoE Injector IEEE 802.3at compliant, AC 100~240V, with universal connectors (for A416, A418, B913, B923, B934, Q450, Q75, VMGB-400, VMGB-603, VMGB-604, Z36, Z37, Z71, Z710, Z952)

PPOE-0106  High PoE Injector IEEE 802.3at compliant, AC 100~240V, with universal connectors (for A416, A418, B913, B923, B934, Q450, Q75, VMGB-60X, Z37, Z71, Z952)

Network & Storage Peripherals - Data Switch

PPSW-0102  PLANET FGSD-1011HP 8-Port 802.3at PoE Switch (PoE Budget 120W)

PPSW-0105  PLANET GS-4210-8P2C 8-Port Gigabit 802.3at Managed PoE Switch (PoE Budget 120W)

PPSW-1101  PLANET GS-4210-24PL4C 24-Port Gigabit 802.3at Managed PoE Switch (PoE Budget 440W)

PPSW-3100  PLANET FGSW-1816HPS 16-Port 802.3at PoE Switch (PoE Budget 220W)

Extenders - PoE Extender

PPEX-0100  Veracity OUTREACH Max Power over Ethernet (PoE) Extender

Extenders - PoE over Coaxial Extender Kit

PPOC-0100  Planet LRP-101C-KIT Power over Coax Adapter Kit

Audio Devices - Microphone

PMIC-0100  Active Microphone Omnidirectional for all Cameras with Line-in Audio

PMIC-0200  Passive Microphone Omnidirectional for all Cameras with Mic-in Audio using 3.5mm Phone Jack

Illuminators - IR LED Illuminator

PLED-0200  SPINLUX (SL-A2IRXX10-24CL) IR Illuminator 10° Angle with 120 m approx. range

PLED-0201  SPINLUX (SL-A2IRXX25-24CL) IR Illuminator 25° Angle with 50 m approx. range