

User Manual



4K Decoder

Please read this manual thoroughly before use and keep it handy for future reference.

WARNING

TO REDUCE THE RISK OF FIRE OR ELECTRIC SHOCK, DO NOT EX- POSE THIS PRODUCT TO RAIN OR MOISTURE. DO NOT INSERT ANY METALLIC OBJECT THROUGH THE VENTILATION GRILLS OR OTHER OPENNINGS ON THE EQUIPMENT.

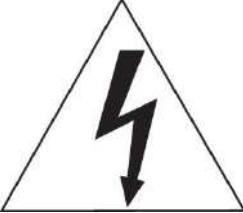
CAUTION

	CAUTION RISK OF ELECTRIC SHOCK DO NOT OPEN	
<p>WARNING: TO REDUCE THE RISK OF ELECTRIC SHOCK, DO NOT REMOVE COVER (OR BACK). NO USER-SERVICABLE PARTS INSIDE. REFER SERVICING TO QUALIFIED SERVICE PERSONNEL</p>		

EXPLANATION OF GRAPHICAL SYMBOLS

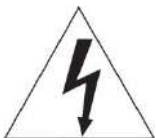

The lightning flash with arrowhead symbol, within an equilateral triangle, is intended to alert the user to the presence of dangerous voltage within the products enclosure that may be of sufficient magnitude to constitute a risk of electric shock to persons.



The exclamation point within an equilateral triangle is intended to alert the user to the presence of important operating and maintenance (servicing) instructions in the literature accompanying the product.

FCC COMPLIANCE STATEMENT

This device complies with Part 15 of the FCC Rules. Operation is subject to the following two conditions: (1) this device may not cause harmful interference, and (2) this device must accept any interference received, including interference that may cause undesired operation.

FCC INFORMATION: This equipment has been tested and found to comply with the limits for a Class A digital device, pursuant to Part 15 of the FCC Rules. These limits are designed to provide reasonable protection against harmful interference when the equipment is operated in a commercial environment. This equipment generates, uses, and can radiate radio frequency energy and, if not installed and used in accordance with the instruction manual, may cause harmful interference to radio communications. Operation of this equipment in a residential area is likely to cause harmful interference in which case the user will be required to correct the interference at his own expense.

CAUTION: Changes or modifications not expressly approved by the party responsible for compliance could void the user's authority to operate the equipment.

This Class A digital apparatus complies with Canadian ICES-003.
Cet appareil numérique de la classe A est conforme à la norme NMB-003 du Canada.

CE COMPLIANCE STATEMENT

WARNING

This is a Class A product. In a domestic environment this product may cause radio interference in which case the user may be required to take adequate measures.

CAUTION

RISK OF EXPLOSION IF BATTERY IS REPLACED BY AN INCORRECT TYPE.
DISPOSE OF USED BATTERIES ACCORDING TO THE INSTRUCTIONS.

IMPORTANT SAFETY INSTRUCTIONS

1. Read these instructions.
2. Keep these instructions.
3. Heed all warnings.
4. Follow all instructions.
5. Do not use this apparatus near water.
6. Clean only with dry cloth.
7. Do not block any ventilation openings. Install in accordance with the manufacturer's instructions.
8. Do not install near any heat sources such as radiators, heat registers, stoves, or other apparatus (including amplifiers) that produce heat.
9. Do not defeat the safety purpose of the polarized or grounding-type plug. A polarized plug has two blades with one wider than the other. A grounding type plug has two blades and a third grounding prong. The wide blade or the third prong is provided for your safety. If the provided plug does not fit into your outlet, consult an electrician for replacement of the obsolete outlet.
10. Protect the power cord from being walked on or pinched particularly at plugs, convenience receptacles, and the point where they exit from the apparatus.
11. Only use attachments/accessories specified by the manufacturer.
12. Use only with the cart, stand, tripod, bracket, or table specified by the manufacturer, or sold with the apparatus. When a cart is used, use caution when moving the cart/apparatus combination to avoid injury from tip-over.
13. Unplug this apparatus during lightning storms or when unused for long periods of time.
14. Refer all servicing to qualified service personnel. Servicing is required when the apparatus has been damaged in any way, such as power-supply cord or plug is damaged, liquid has been spilled or objects have fallen into the apparatus, the apparatus has been exposed to rain or moisture, does not operate normally, or has been dropped.
- 15. CAUTION – THESE SERVICING INSTRUCTIONS ARE FOR USE BY QUALIFIED SERVICE PERSONNEL ONLY. TO REDUCE THE RISK OF ELECTRIC SHOCK DO NOT PERFORM ANY SERVICING OTHER THAN THAT CONTAINED IN THE OPERATING INSTRUCTIONS UNLESS YOU ARE QUALIFIED TO DO SO.**
- 16. Use satisfy clause 2.5 of IEC60950-1/UL60950-1 or Certified/Listed Class 2 power source only.**
17. ITE is to be connected only to PoE networks without routing to the outside plant.



Table of Contents

Table of Contents	1
1. Overview	3
1.1 Package Contents	4
1.2 Decoder Description	4
2. Installation	6
2.1 Starting System	6
2.2 Quick Setup	7
2.2.1 Account	7
2.2.2 System	8
2.2.3 Network.....	9
2.2.4 Time/Date.....	9
2.2.5 Easy Installation Wizard	10
3. Live Screen Configuration	11
3.1 Icons in Live screen	12
3.2 Quick menu.....	13
3.2.1 Channel Assign	14
4. Setup menu.....	15
4.1 General buttons in Setup menu.....	16
4.2 SYSTEM.....	17
4.2.1 System	17
4.2.2 Time/Date.....	19
4.2.3 Account > User	20
4.2.4 Configuration (Config)	22
4.3 CAMERA.....	24
4.3.1 Channel	24
4.4 DEVICE	25
4.4.1 Display.....	25
4.4.2 Serial Device	29
4.5 EVENT.....	30
4.5.1 Alarm In	30
4.5.2 Motion	31
4.5.3 Video Loss.....	31
4.6 NETWORK	32
4.6.1 Basic	32
5. Web Setup.....	33
5.1 Log In	33

5.2	General buttons in Setup menu	34
5.3	SYSTEM	35
5.3.1	System	35
5.3.2	Time/Date.....	37
5.4	CAMERA	38
5.4.1	Channel Assign	38
5.5	DEVICE.....	39
5.5.1	Display.....	39
5.5.2	External	40
5.6	EVENT	41
5.6.1	Alarm In	41
5.6.2	Motion	42
5.6.3	Video Loss.....	42
5.7	NETWORK	43
5.7.1	Basic	43
6.	Product Specification	44

1. Overview

This chapter describes device overview, components and their terms and features.

This product is a device that displays images transmitted from an IP camera on monitor.

The device features include the following:

- Convenient UI from user's viewpoint
- 16 IP camera input
- Providing H.264, H.265 compression
- Support dashboard display
- 4K resolution support
- Remote control through a network or local monitor

1.1 Package Contents

The device package contents consist of the following:

 **Note** Please check all components involved.

Table 1-1 Package contents

No	Name	No	Name
1	Decoder	2	Mounting Bracket
3	DC 12V Adaptor	4	Bracket fixing screw
5	Quick guide	6	Program CD

1.2 Decoder Description

Each part is listed in the below:

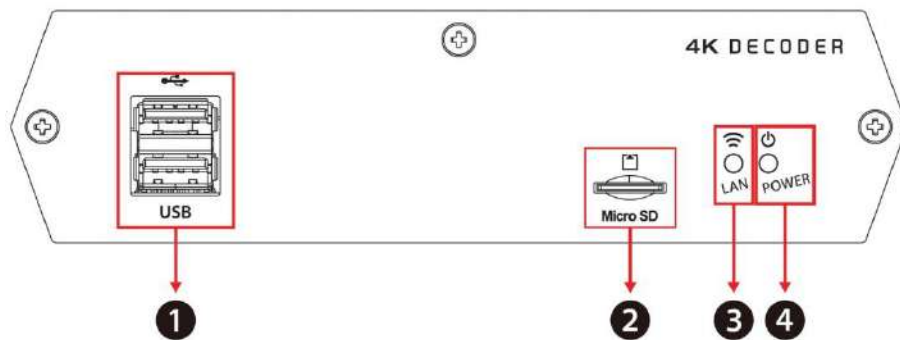

Figure 1-1 Name and Connection of each front section

Table 1-2 Name and Function of each front section

No.	Name	Function
1	USB port	USB port is connected for USB mouse or firmware upgrade.
2	Micro SD	Store media file.
3	LAN LED	Pointing out network in connection.
4	Power status LED	Pointing out device on/off.
5	USB port	USB port is connected for USB mouse or firmware upgrade, and data back-up.

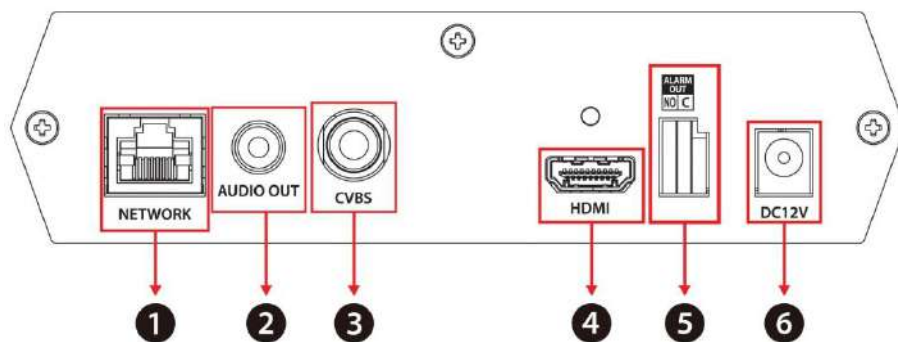

Figure 1-2 Name and Connection of rear section

Table 1-3 Name and Function of rear section

No.	Name	Function
1	NETWORK	Network connector for IP Camera and CMS.
2	AUDIO OUT	Audio output port.
3	CVBS	CVBS(Spot Video) output port.
4	HDMI	HDMI output port.
5	ALARM OUT	Alarm output connector.
6	DC12V	Power supply connector.

2. Installation

You can fix the product on the wall using the supplied bracket.

Refer to the drawing below for the hole position of the bracket.

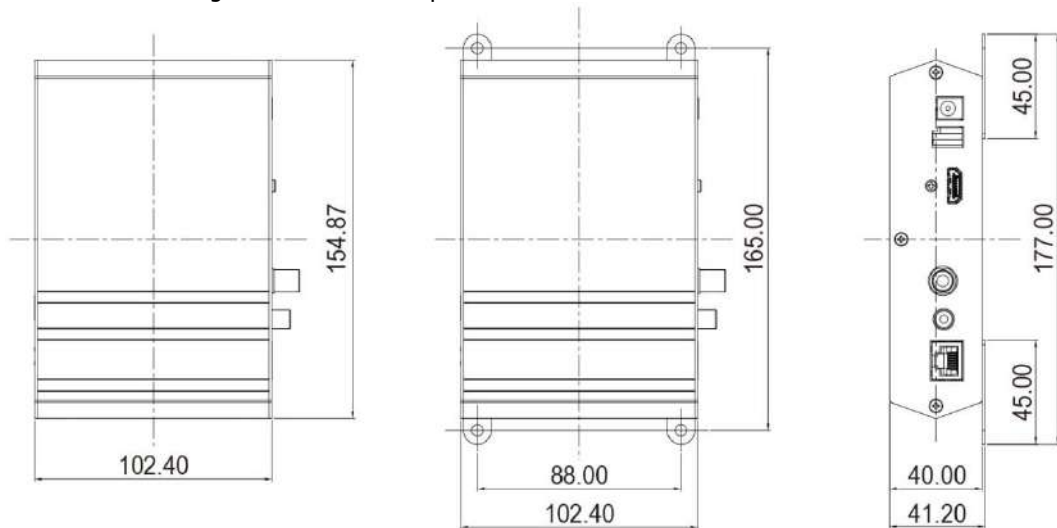

Figure 2-1 Dimension

2.1 Starting System

Power supply begins with system operation as follows:

- 1 Switching on initialize with below icons in order.



- 2 With buzzer sounds, the start screen is presented.

- 3 In **Log in** screen, enter the **ID**, **Password** and press **OK**.

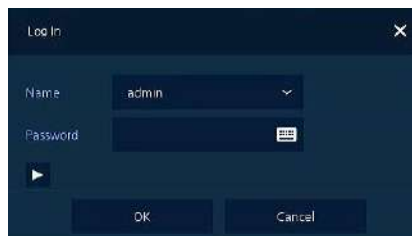

Note Default **ID & Password** is admin/admin.

Attention

Please change password after login due to security.

2.2 Quick Setup

Select to **Run** for easy installation.

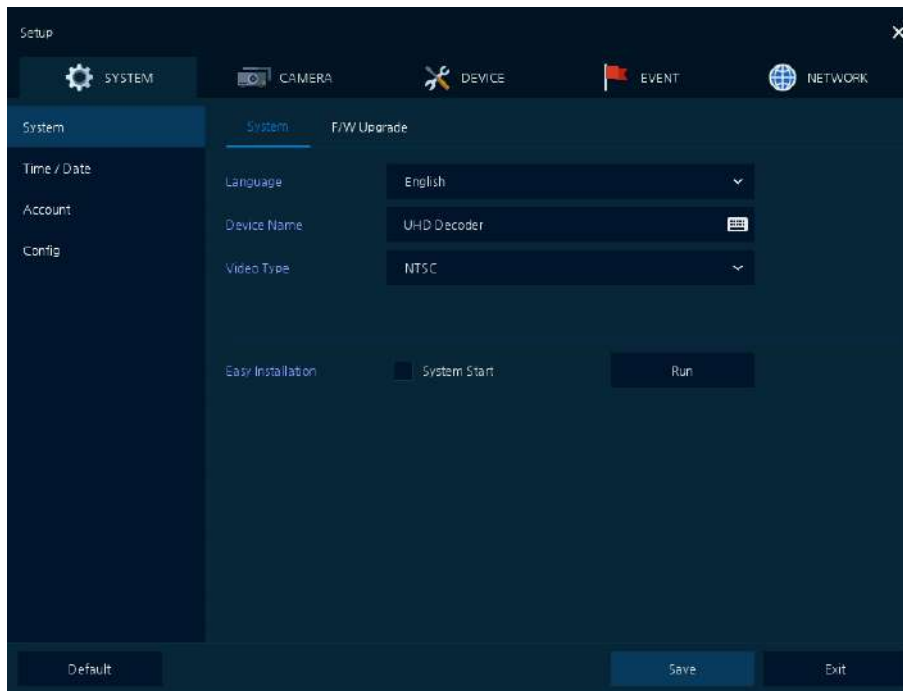

2.2.1 Account

1 Set **ID** and **Password**.

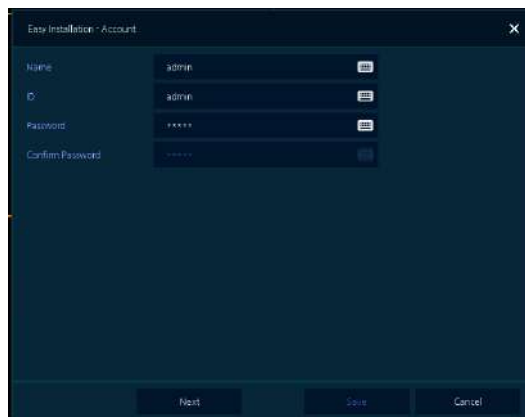

Note

- Default ID/Password is admin/admin.
 - Change the password for security.
-

2.2.2 System

How to set the system of Easy Installation:

- 1 Set each item in **System** setting screen.

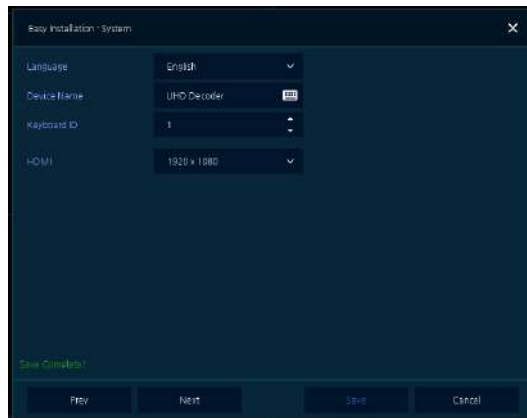

- Language: Select system language.
- Device Name: Enter the device name.
- Keyboard ID: Default keyboard ID is 1.
- HDMI: Set resolution of a monitor connected to the device.

- 2 Press **Save** button to save set value.

- 3 Press **Next** to end System setting and move the next setting phase.

2.2.3 Network

How to set the network of Easy Installation:

- 1 Set each item in **Network** setting screen.

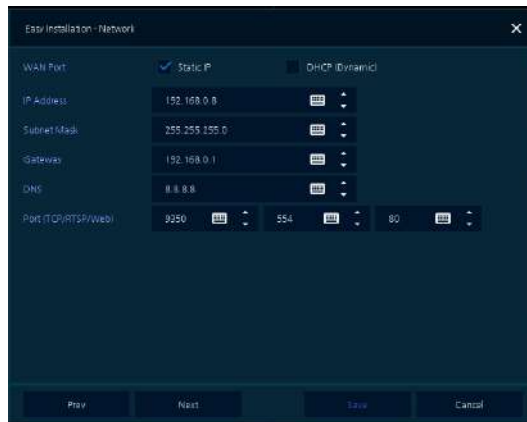

- WAN Port: Select whether to use static IP or dynamic IP.
 - IP Address, Subnet Mask, Gateway, DNS, Port, and RTSP port server: As for dynamic IP, enter information in each space.
- 2 Press **Save** button to save set value.
 - 3 Press **Next** to end Network setting and move the next setting phase.

2.2.4 Time/Date

How to set the time/date of Easy Installation:

- 1 Set each item in **Time/Date** setting screen.

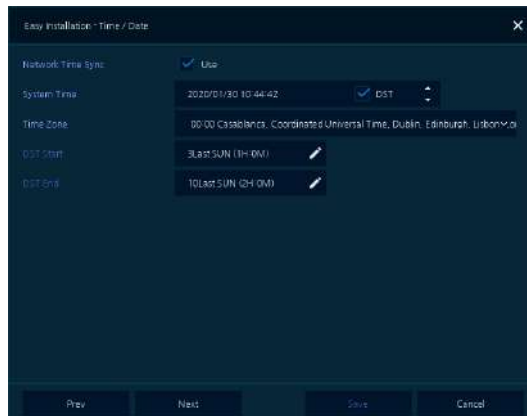

- Network Time Sync: Select network for synchronizing with time server.
 - System Time: Not for synchronizing with network time server, set the device time; otherwise (applying for Daylight saving time), select DST.
 - Time Zone: Select time zone for the system being installed.
 - DST Start/End: For applying Daylight saving time, set the application period.
- 2 Press **Save** button to save set value.
 - 3 Press **Next** to end Time/Date setting and move the next setting phase.

2.2.5 Easy Installation Wizard

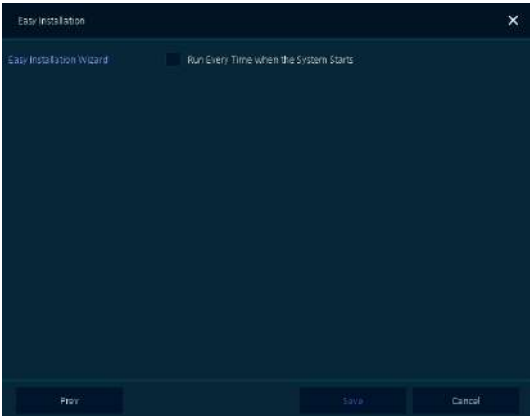

- 1 Select to run Easy Installation every time when the system start.
- 2 Press **Save** button to save set value and end Easy Installation.

3.1 Icons in Live screen

Each icon in the live screen displays a present setting status or a function. UI screen consists of like below.

Note Chosen live screen is marked as a blue frame; mouse-located live screen is marked as yellow one.

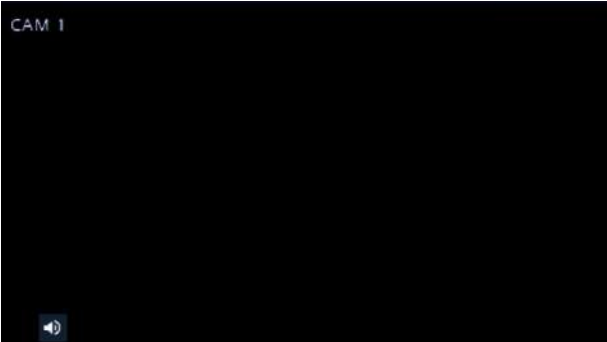



Figure 3-2 Live screen icon

Table 3-2 Live screen icon and its description

No.	Icon	Description
1		Display channel number.
2		Speaker on/off.

3.2 Quick menu

This chapter depicts Quick menu when users click the right button of the mouse in live screen.



Figure 3-3 Quick menu

Table 3-3 Quick menu Item and Description

No.	Item	Description
1	Screen Mode	Selecting the partition mode of live screen. (Full, 2X2, 1+7, 3X3, 2+8, 4x4, PIP and Save Sequence) User can change the channel display order by pressing and holding the screen. When the order is changed, the Save Sequence menu appears in the screen mode and user can select Save to save the sequence.
2	Zoom in	Magnifying selected live screen (Zoom out, 2 times, 4 times, and 8 times).
3	Sequence	Set the sequence.
4	Speaker Output/Mute	Turning on/off a sound speaker.
5	Stop Alarm	Set the Stop Alarm.
6	Setup	Opens the main set up menu. For more information about setting menu, see section "4 Setup menu".
7	Manual Delete	Delete registered cameras.
8	Channel Assign	Opens a pop-up menu for Channel Assign.
9	Log in/Log out	Log in/Log out.
10	Shutdown	Shuts down or restarts the device (shutdown, restart).

3.2.1 Channel Assign

Users can assign the channel.

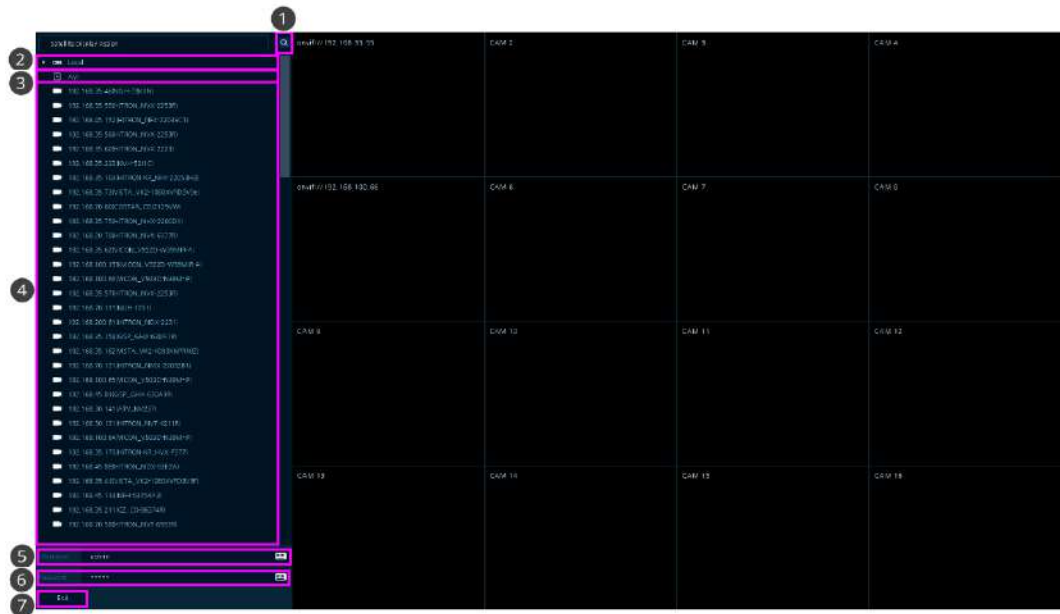

Figure 3-4 Channel Assign

Table 3-4 Camera Registration

No.	Item	Description
1		Search the device registered.
2	Local	Display registered image list.
3	AVI	Display media file list. Drag & drop the desired media file. Drag the screen and drop it on the AVI to unregister the selected media file.
4	List	Displayed registered device list. Drag & drop the desired channel. Drag the screen and drop it on the list to unregister the selected channel.
5	Username	Enter the ID of the device.
6	Password	Enter the password of the device.
7	Exit	Close the window after save.

4. Setup menu

This chapter describes Setup menu.



Figure 4-1 Setup menu

Selecting the menu opens the setting screen.

Note Setup screen is available to click **Setup** in Quick menu by clicking the right button of the mouse.

Table 4-1 Setup menu Item and Description

No.	Item	Description
1	SYSTEM	Setting the system environment.
2	CAMERA	Setting the camera.
3	DEVICE	Setting the devices connected to the decoder.
4	EVENT	Setting the event type.
5	NETWORK	Setting the network environment.

Setup menu includes:

Table 4-2 Setup menu tree

1 Depth	2 Depth	3 Depth
SYSTEM	System	System
		F/W Upgrade
	Time/Date	Time/Date
	Account	User
	Config	Export/Import
Factory Default		
CAMERA	Channel	Basic
DEVICE	Display	Display
		OSD
		Sequence
		Media Sequence
	Serial Device	Serial Device
Event	Alarm In	Setup
	Motion	Setup
	Video Loss	Setup
NETWORK	Basic	WAN Port

4.1 General buttons in Setup menu

This section depicts General buttons in Setup menu.

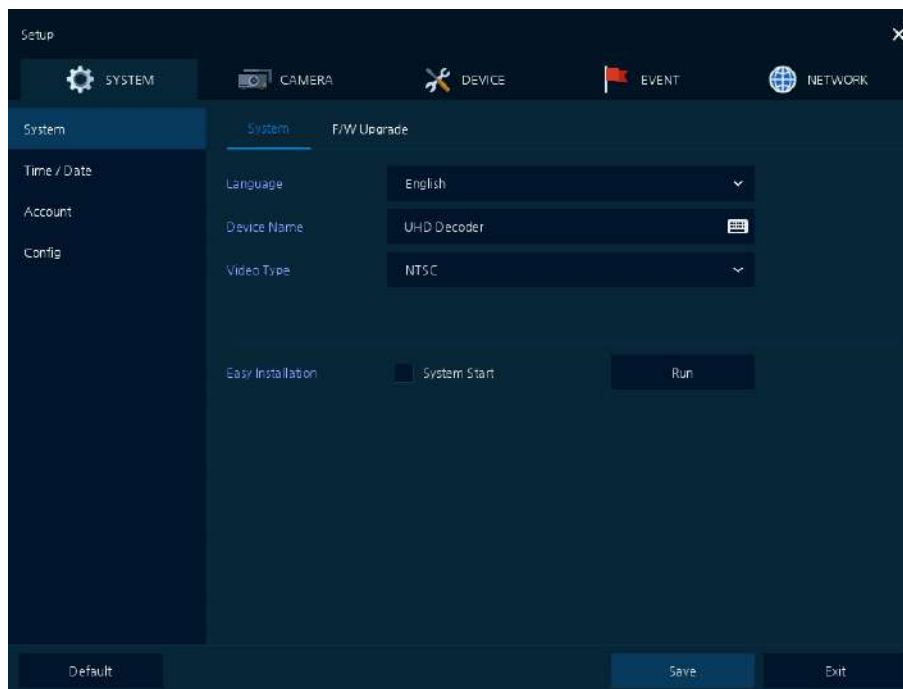

Figure 4-2 General buttons in Setup menu

Table 4-3 Item and Description of General buttons in Setup menu

No.	Item	Description
1	Default	Reverse changed setting value to default in factory.
2	Save	Save the set content.
3	Cancel	Cancel the set value.
4	Restore	Cancel the set value, and reverse it to default.
5	Apply	Apply the content set.

4.2 SYSTEM

In **SYSTEM**, basic system environment is set.



4.2.1 System

Set and upgrade the basic items of the system.

System > System

Set the basic items in the System.

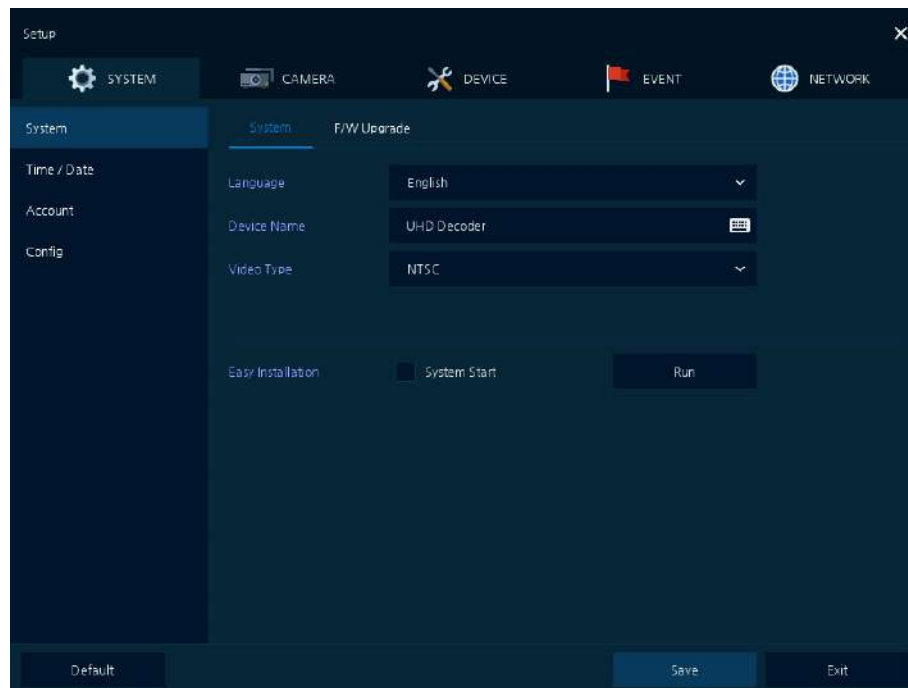

Figure 4-3 SYSTEM > System > System

Table 4-4 SYSTEM > System > System Item and Description

No.	Name	Function
1	Language	Set the system language.
2	Device Name	Enter the device name.
3	Video Type	Select image standard types (NTSC, PAL).
4	Easy Installation	Select Easy Installation in starting the system.
5	Run button	Run Easy Installation.

System > F/W Upgrade

Set the upgraded items of the system.

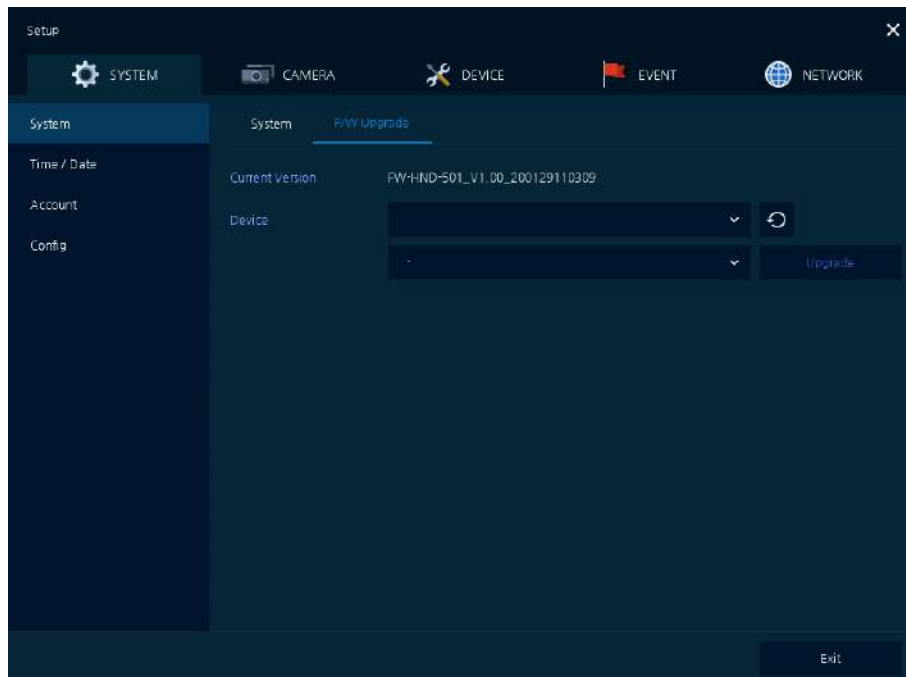

Figure 4-4 SYSTEM > System > F/W Upgrade

Table 4-5 SYSTEM > System > F/W Upgrade Item and Description

No.	Name	Function
1	Current Version	Displaying the present tool version.
2	Device	Connect USB memory that has files to upgrade to the USB port, select files to upgrade.
3	Upgrade button	Run upgrade.

4.2.2 Time/Date

Set the date, time, and holidays of the system.

Time/Date > Time/Date

Set the date, time, and holidays of the system.

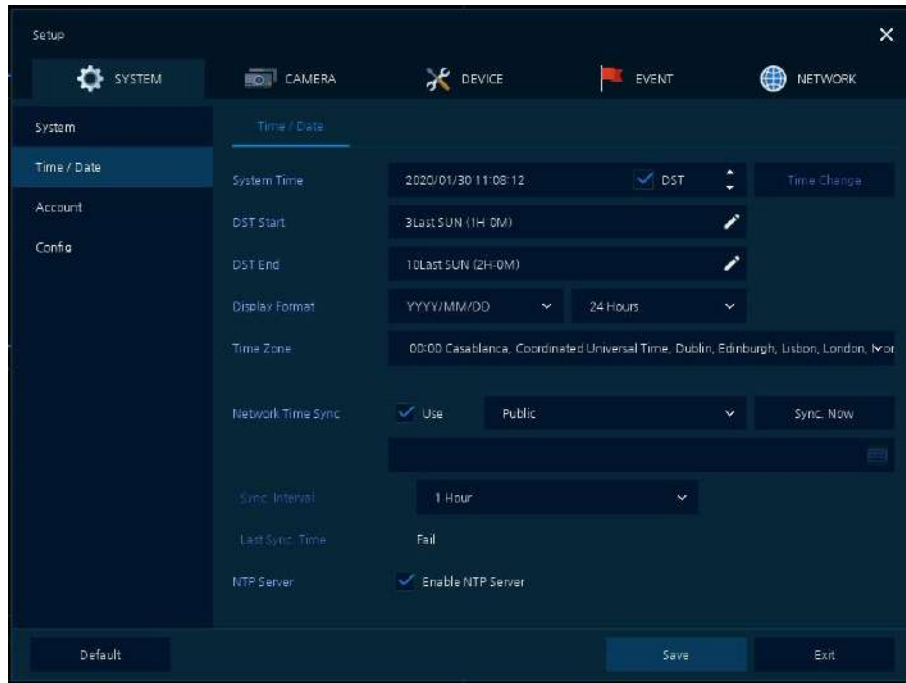

Figure 4-5 SYSTEM > Time/Date > Time/Date

Table 4-6 SYSTEM > Time/Date > Time/Date Item and Description

No.	Name	Function
1	System Time	Set the date and time. <ul style="list-style-type: none"> DST: Select whether to use summer time.
2	DST Start	Set the starting date of summer time
3	DST End	Set the ending date of summer time
4	Display Format	Select the format to present date and time.
5	Time Zone	Select time zone.
6	Network Time Sync	For using a specific network time server, click the Use checkbox and enter the server address. <ul style="list-style-type: none"> Sync. Interval: Select synchronization period (1~7-hour) Last Sync. Time: Displaying the final synchronized time
7	NTP Server	Select whether to use the device as an NTP server.

4.2.3 Account > User

Set the user's account of the system.

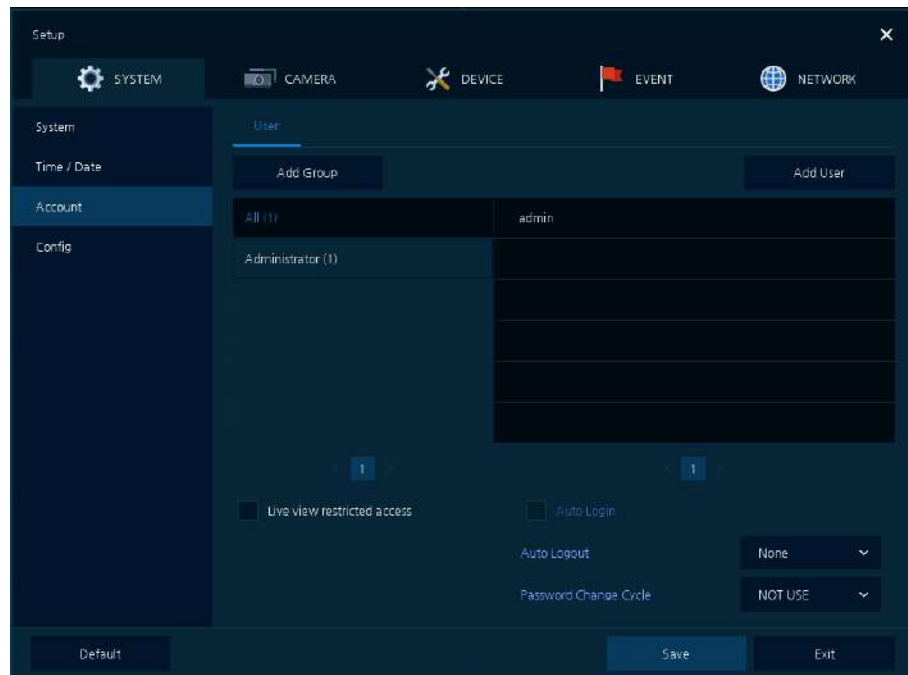

Figure 4-6 SYSTEM > Account > User

Table 4-7 SYSTEM > Account > User Item and Description

No.	Name	Function
1	Add Group	Add users' group.
2	Add User	Add user.
3	Group List	Display a total group list.
4	User List	Display user lists across groups.
5	Live view restricted access	Do not display live video if log it out.
6	Auto Login	Click/clear the automatic login checkbox.
7	Auto Logout	Select automatic logout time (Null, 1min, 2min, 3min, 4min, 5min, 6min, 7min, 8min, 9min, 10min, and 30min).
8	Password Change Cycle	If enable, user should change the password periodically. (Not use, 1month~12month)

Press **Add Group** button, then **Add Group** screen displays.

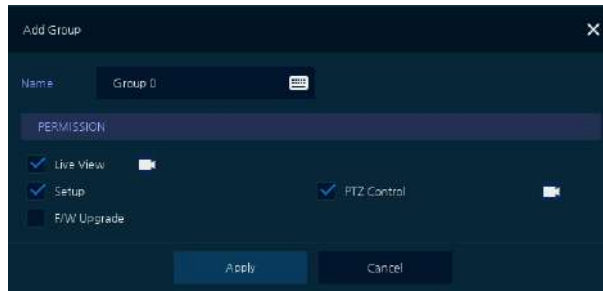



Figure 4-7 SYSTEM > Account > User > Add Group

Table 4-8 SYSTEM > Account > User > Add Group Item and Description

No.	Name	Function
1	Name	Enter the group name.
2	PERMISSION	Select items to permit access.
3		Select channels to permit access. (Live View, Setup, F/W Upgrade, PTZ Control)

Press **Add User** button, then **Add User** screen displays.

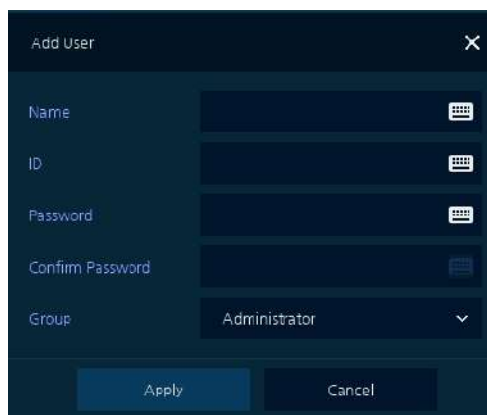

Figure 4-8 SYSTEM > Account > User > Add User

Table 4-9 SYSTEM > Account > User > Add User Item and Description

No.	Name	Function
1	Name	Enter the user name.
2	ID	Enter the user ID.
3	Password	Enter the password.
4	Confirm Password	Confirm the password.
5	Group	Select to the group to which belongs.

4.2.4 Configuration (Config)

Set Export/Import and Factory Default of the system.

Config > Export/Import

Through a save medium, users may apply information set to other devices identically.

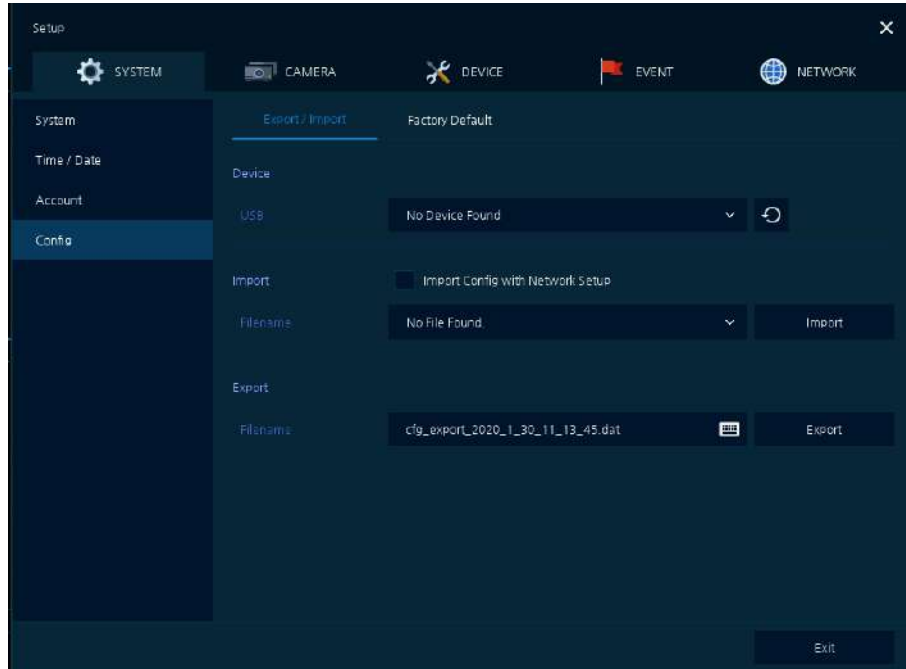

Figure 4-9 SYSTEM > Config > Export/Import

Table 4-10 SYSTEM > Config > Export/Import Item and Description

No.	Name	Function
1	Device	Select an exterior connector with USB. <ul style="list-style-type: none"> USB: Displays the USB device connected. Refresh button: Re-recognize the device.
2	Import	Apply information saved in USB to the device. <ul style="list-style-type: none"> Import Config with network setup: The network setting information is brought from the setting information. Filename: Select setting file. Import button: The file in USB is brought to the designated device.
3	Export	Save the set information in the USB. <ul style="list-style-type: none"> Filename: Set filename to be exported. Export button: Save the set information in the USB.

Config > Factory Default

Default the setting value of the device.

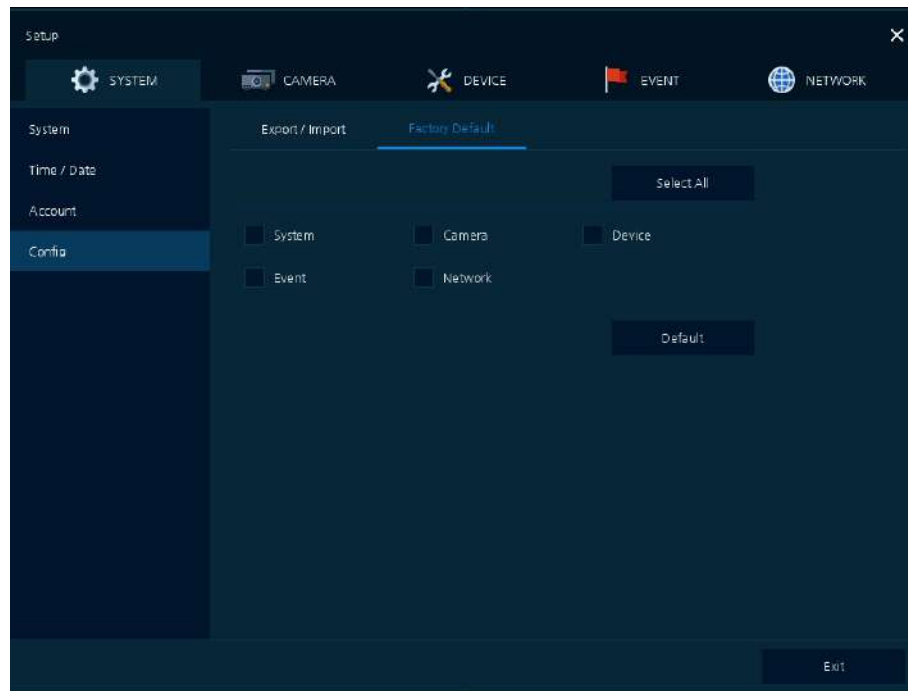

Figure 4-10 SYSTEM > Config > Factory Default

Table 4-11 SYSTEM > Config > Factory Default Item and Description

No.	Name	Function
1	Select All /Unselect All	Select/deselect all items to be defaulted.
2	Default Item	Select/deselect related items to be defaulted. (System, Camera, Device, Event, Network)
3	Default button	Default the system to the basics.

4.3 CAMERA

In **Camera** section, set the camera to be connected with the device.



4.3.1 Channel

Channel > Basic

Set the basic items of camera by channels.

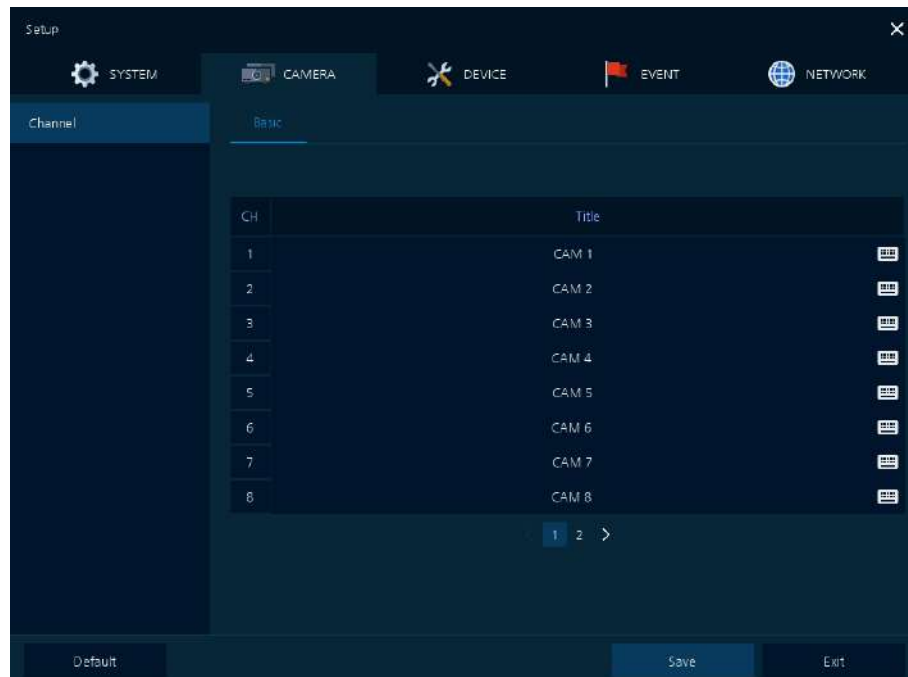

Figure 4-11 CAMERA > Channel > Basic

Table 4-12 CAMERA > Channel > Basic Item and Description

No.	Name	Function
1	CH	Display the channel name.
2	Title	Enter the camera name of relevant channels.

4.4 DEVICE

In **DEVICE**, set the device to connect with the unit.



4.4.1 Display

Set matters related to a display device and live screen.

Display > Display

Set the display device.

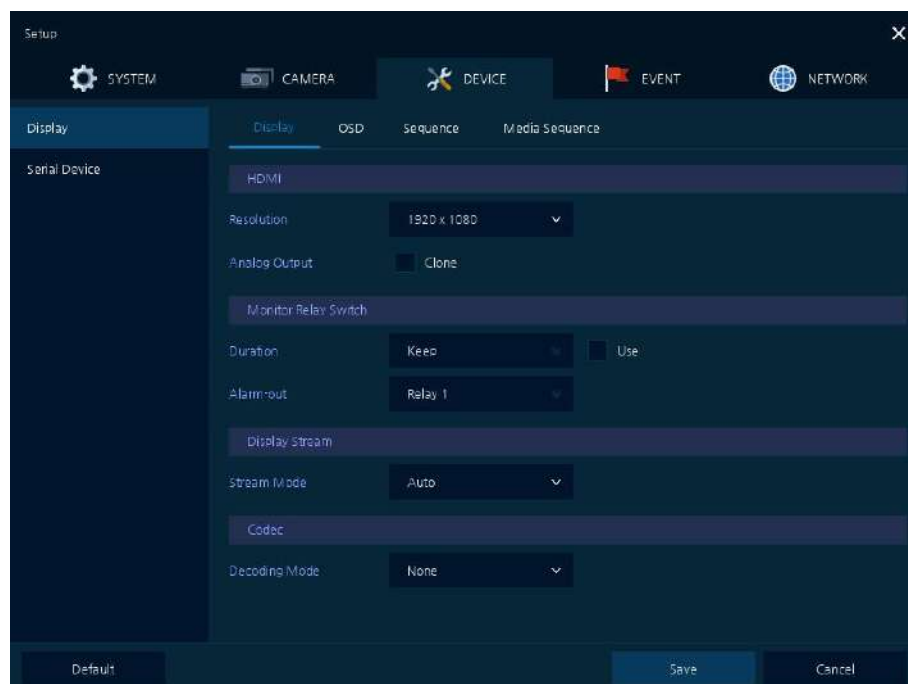

Figure 4-12 DEVICE > Display > Display

Table 4-13 DEVICE > Display > Display Item and Description

No.	Name	Function
1	HDMI	Select the resolution of the display device (1920x1080, 3840x2160). Analog Output: Copy HDMI main output to analog output.
2	Monitor Relay Switch	Select Use to activate the monitor relay switch. Select duration (Keep, 1 Second ~ 1 Hour). Select Alarm-out (Relay 1).
3	Display Stream	Set stream mode (Auto, Sub stream only).
4	Codec	Select Decoding Mode (None, Camera, Time Sync).

Display > OSD

Set the OSD of the display device.

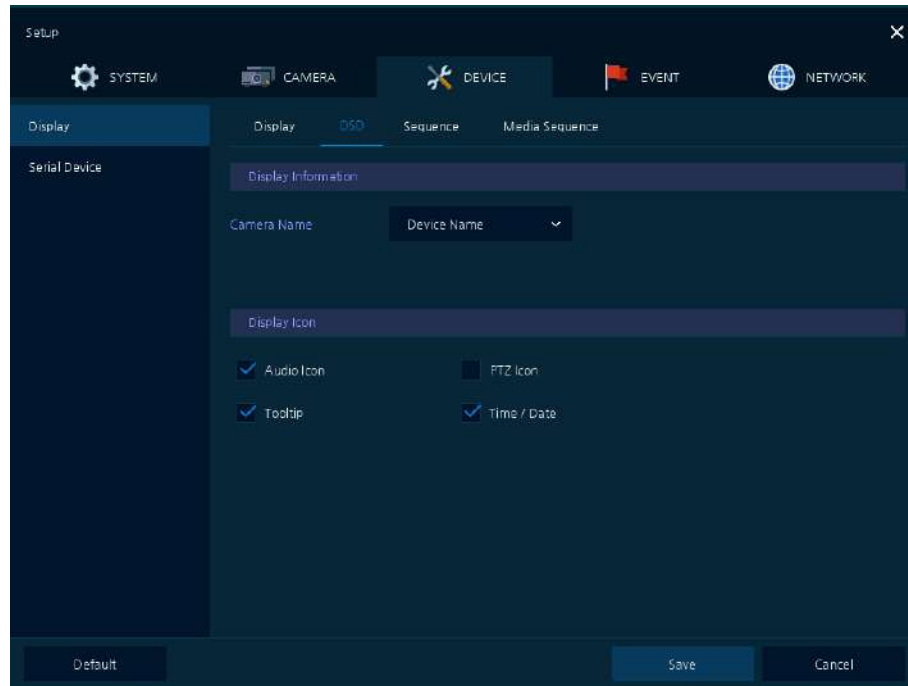

Figure 4-13 DEVICE > Display > OSD

Table 4-14 DEVICE > Display > OSD Item and Description

No.	Name	Function
1	Camera Name	Select the way to display camera in live screen (Off, Device Name, CH+Device Name, Title, CH+Title).
2	Display Icon	Select/deselect icons to display in the live screen.

Display > Sequence

Display selected sequence to media screen in order.

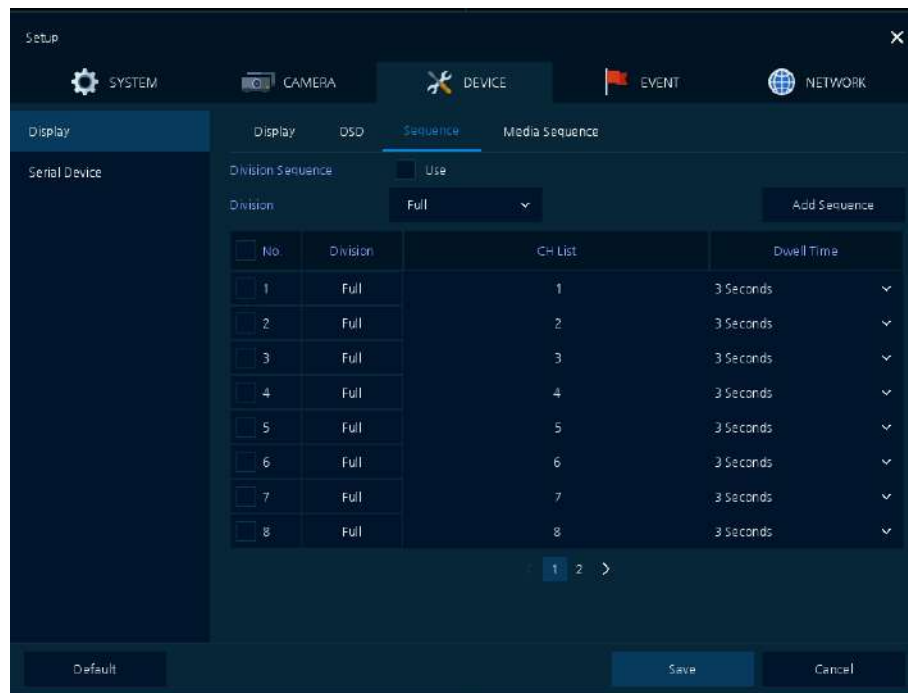

Figure 4-14 DEVICE > Display > Sequence

Table 4-15 DEVICE > Display > Sequence Item and Description

No.	Name	Function
1	Device Sequence	Select Use to active device sequence.
2	Division	Select division and display the full division's channel information.
3	CH List	Display the channel list. Click the channel list, and display the edit sequence screen.
4	Dwell Time	Select dwell time (3, 5, 10, 15, 30 Seconds).

Press **Add Sequence** button, then **Add Sequence** screen displays.

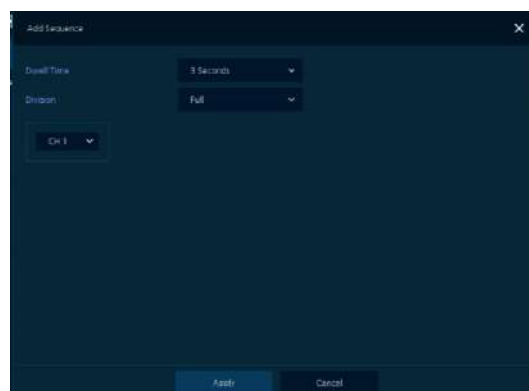

Figure 4-15 DEVICE > Display > Sequence > Add Sequence

Table 4-16 DEVICE > Display > Sequence > Add Sequence

No.	Name	Function
1	Dwell Time	Set dwell time (3, 5, 10, 15, 30 Seconds).
2	Division	Set division (Full).
3	Channel	Set the channel.

Display > Media Sequence

Display selected media sequence to live screen in order.

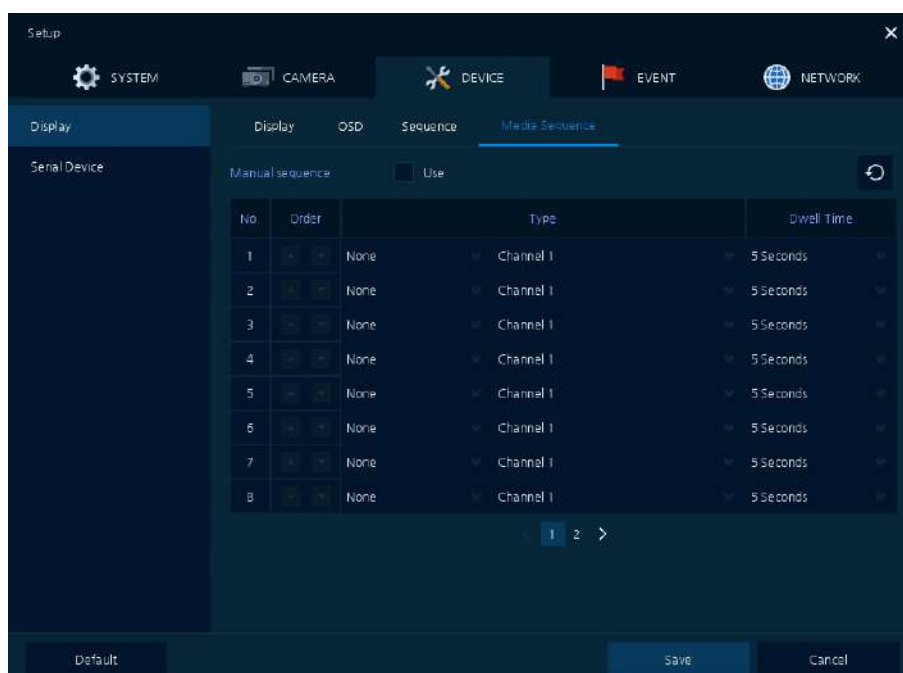



Figure 4-16 DEVICE > Display > Media Sequence

Table 4-17 DEVICE > Display > Media Sequence

No.	Name	Function
1	Manual Sequence	Select Use to active manual sequence.
2		Reset media sequence setting.
3	Order	Set the order of media sequence.
4	Type	Select the type. (None, Camera Image, JPG File, AVI Play) (Channel 1~16)
5	Dwell Time	Set dwell time (5, 10, 15, 30 Seconds, 1, 5 Minutes).

4.4.2 Serial Device

[Serial Device](#) > [Serial Device](#)

Users need to set Serial Device to connect USB device with the unit.

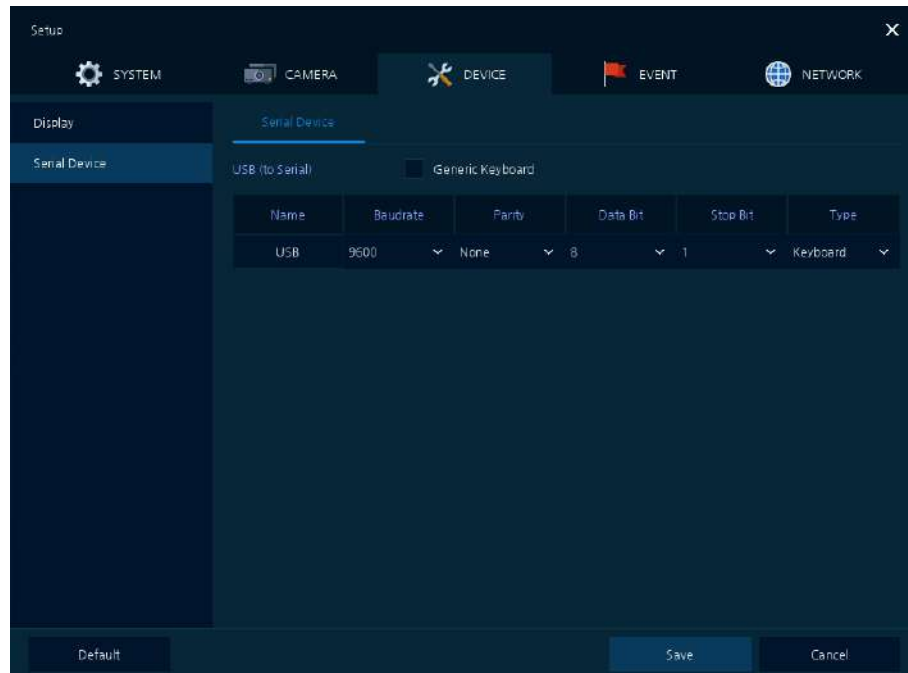

Figure 4-17 DEVICE > Serial Device > Serial Device

Table 4-18 DEVICE > Serial Device > Serial Device Item and Description

No.	Name	Function
1	USB (to Serial)	Set communication transmission value of USB device.

Set the communication transmission value based on the device to be connected.

4.5 EVENT

In **EVENT**, users may set the event type.



4.5.1 Alarm In

[Alarm In > Setup](#)

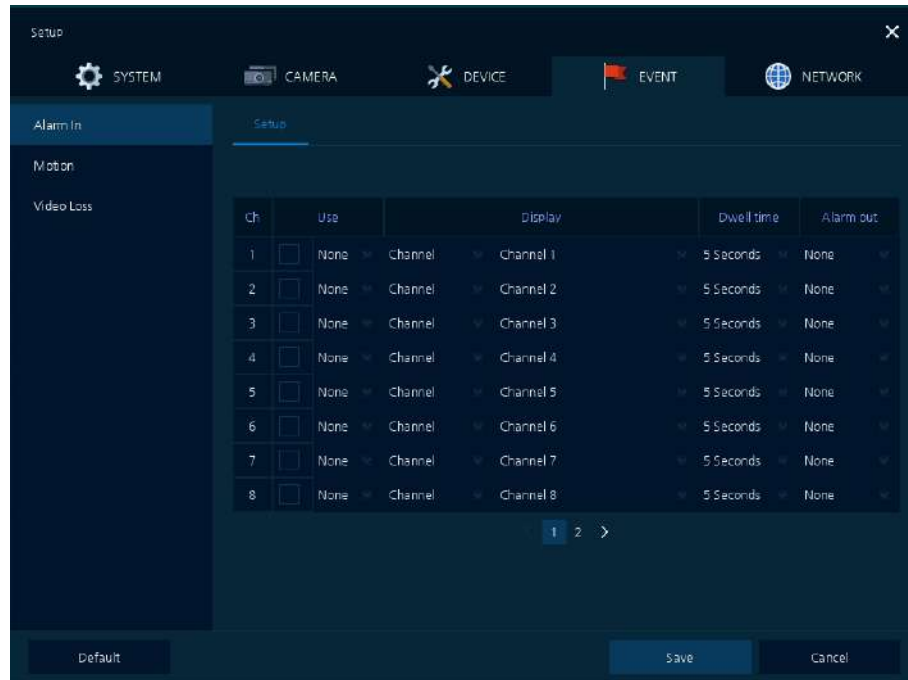

Figure 4-18 EVENT > Alarm In > Setup

Table 4-19 EVENT > Alarm In > Setup Item and Description

No.	Name	Function
1	Ch	Display channel.
2	Use	Select/Unselect Use with None, Popup or PIP.
3	Display	Set Display ((Channel, Media file), (Channel 1~16)).
4	Dwell Time	Select dwell time.
5	Alarm Out	Set the Alarm Out (None, 5 Seconds ~ 5 Minutes).

4.5.2 Motion

Motion > Setup

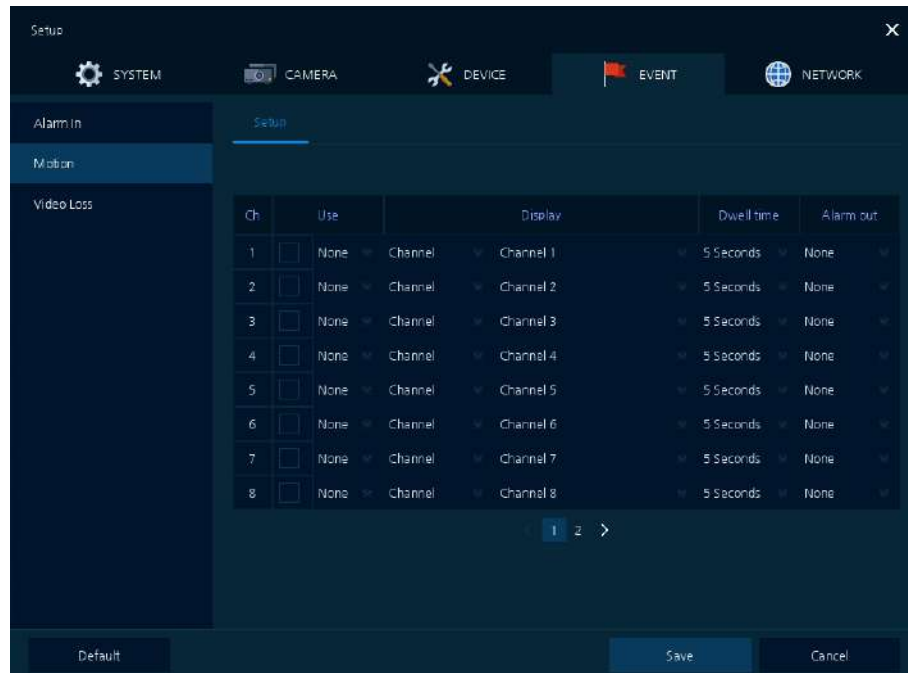

Figure 4-19 EVENT > Motion > Setup

4.5.3 Video Loss

Video > Setup

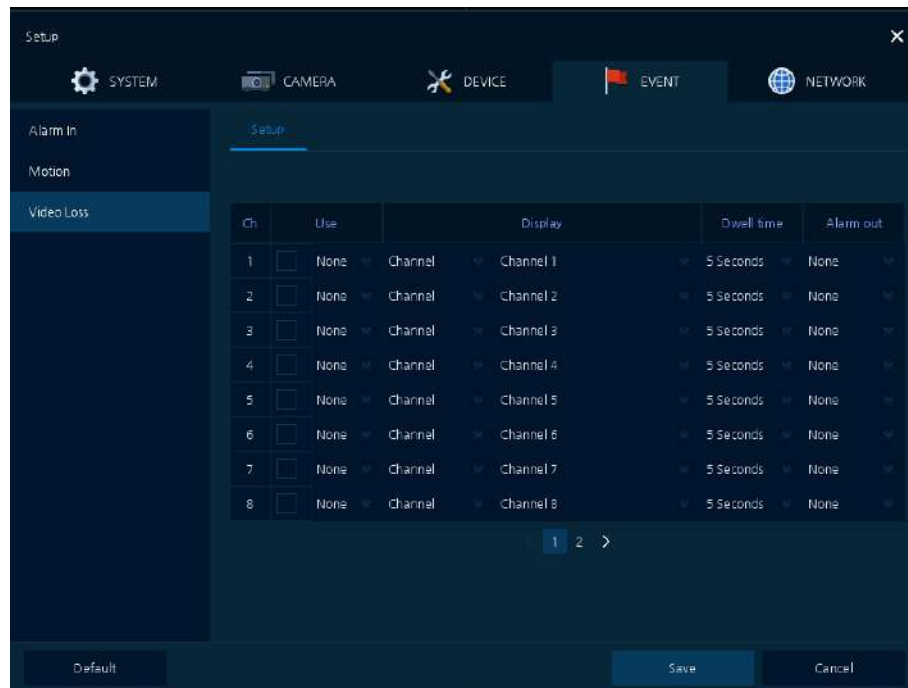

Figure 4-20 EVENT > Video Loss > Setup

4.6 NETWORK

In **NETWORK**, users may set the network environment.



4.6.1 Basic

Basic > WAN Port

To set the network WAN port

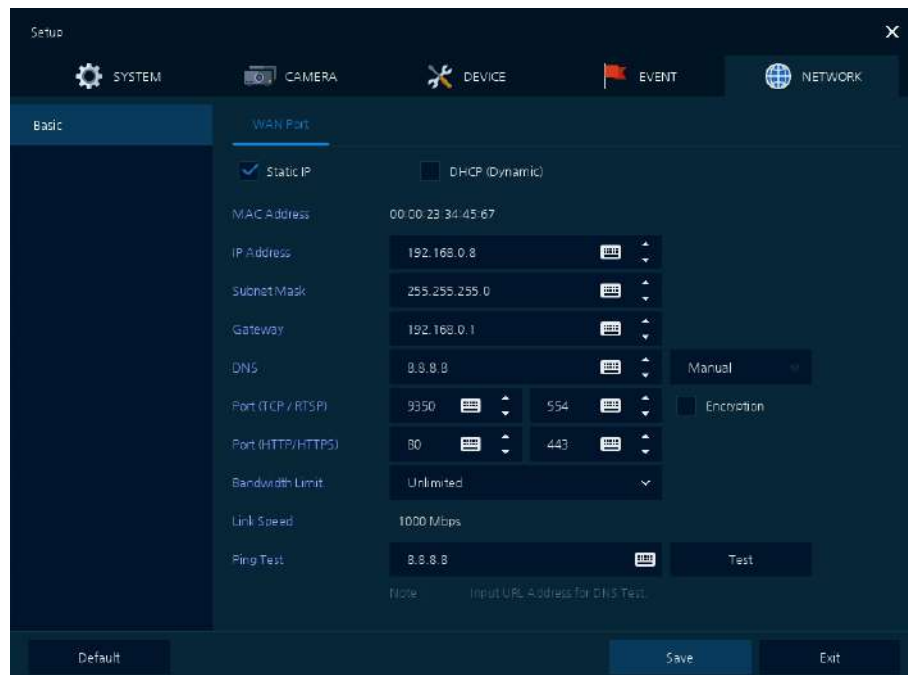

Figure 4-21 NETWORK > Basic > WAN Port

Table 4-20 NETWORK > Basic > WAN Port Item and Description

No.	Name	Function
1	Static IP	Check if you use static IP. For using static IP, enter IP address, Subnet Mask, and Gateway.
2	DHCP (Dynamic)	Select whether to use DHCP (Dynamic).
3	MAC Address	Display the MAC Address.
4	UPnP	Select whether to use UPnP function.
5	DNS	Select manual and enter DNS; otherwise choose automatic function.
6	Port	Enter the port for the stream port and RTSP.
7	Bandwidth Limit	Select bandwidth to limit (no limits, 50Mbps, 10Mbps, 5Mbps, 2Mbps, 1Mbps, 500Kbps, 400Kbps, 300Kbps, 200Kbps, and 100Kbps).
8	Link Speed	Display linked network speed.
9	Ping Test	Enter IP in Ping test and implement the text.

5. Web Setup

5.1 Log In

Enter **ID** and **Password**.

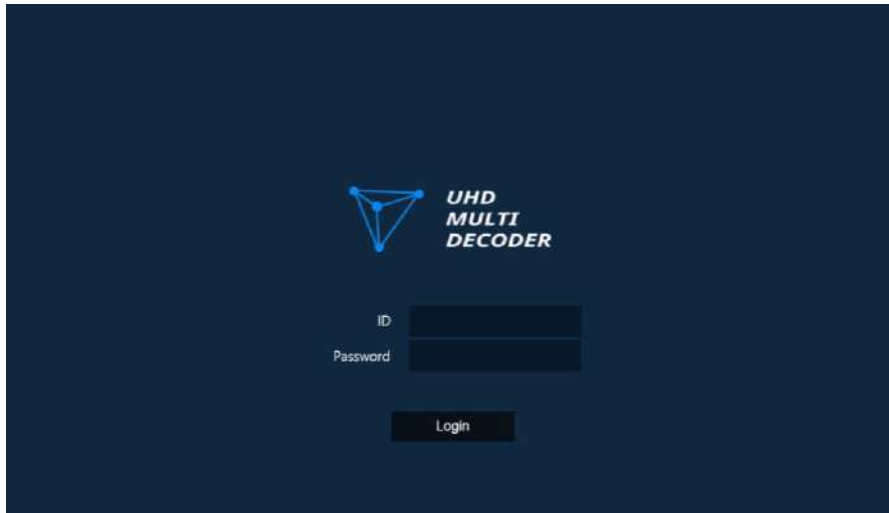

Figure 5-1 Web Setup > Log In

Table 5-1 Web Setup > Log In Item and Description

Note	▪ Default ID/Password is admin/admin.
	▪ Change the password for security.
	▪ Max character length is 12c.

5.2 General buttons in Setup menu

This section depicts General buttons in Setup menu.

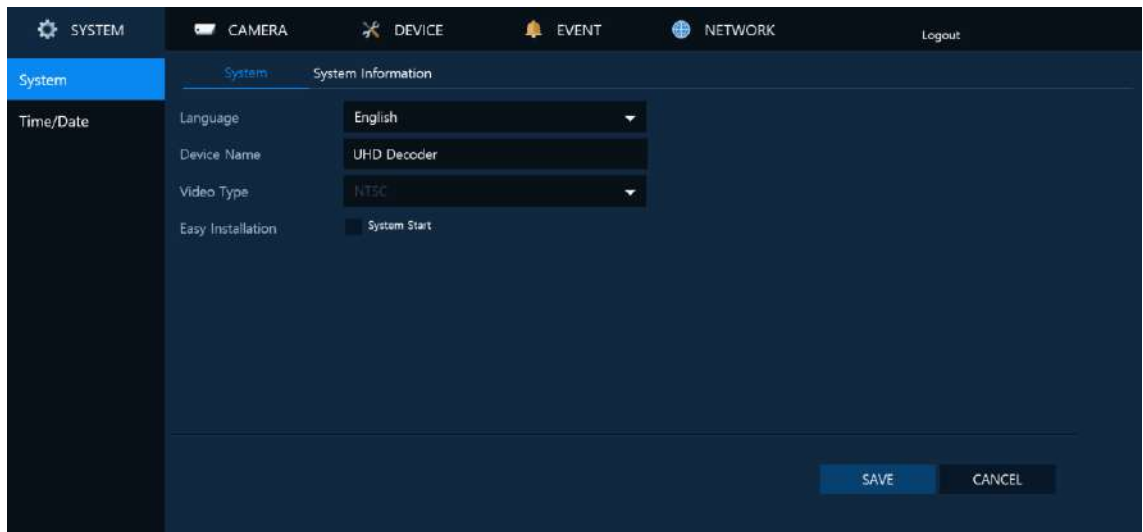

Figure 5-2 General buttons in Setup menu

Table 5-2 Item and Description of General buttons in Setup menu

No.	Item	Description
1	Save	Save the set content.
2	Cancel	Cancel the set value.
3	Default	Reverse changed setting value to default in factory.
4	Restore	Cancel the set value, and reverse it to default.
5	Apply	Apply the content set.
6	Logout	Logout the account.

5.3 SYSTEM

In **SYSTEM**, basic system environment is set.



5.3.1 System

Set and upgrade the basic items of the system.

System > System

Set the basic items in the System.

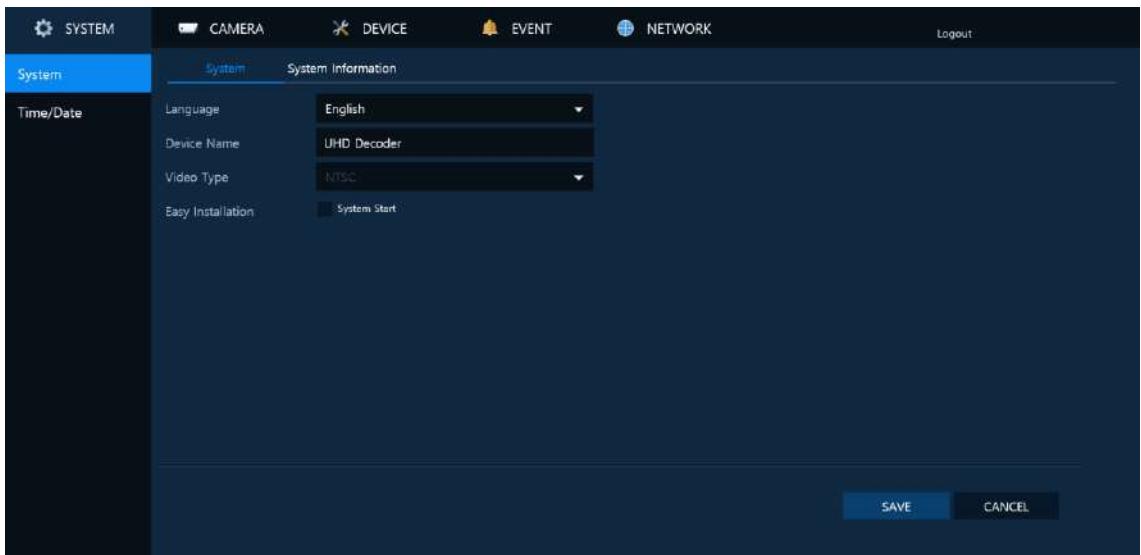

Figure 5-3 SYSTEM > System > System

Table 5-3 SYSTEM > System > System Item and Description

No.	Name	Function
1	Language	Set the system language.
2	Device Name	Enter the device name.
3	Video Type	Select image standard types (NTSC, PAL).
4	Easy Installation	Select the System Start for easy Installation in starting the system.

System > System Information

Display system information.

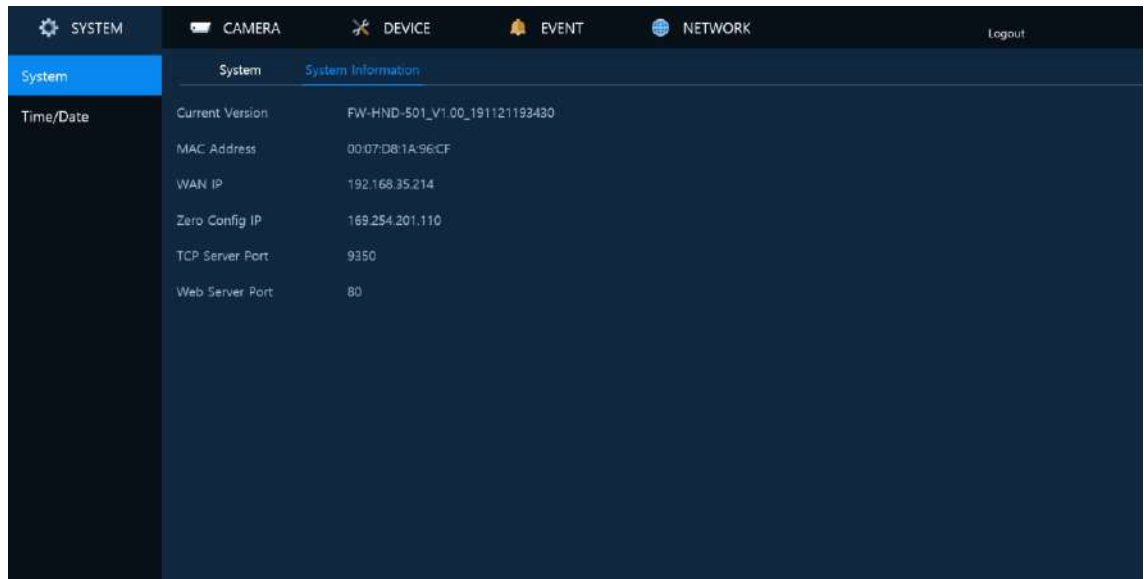

Figure 5-4 SYSTEM > System > System Information

Table 5-4 SYSTEM > System > System Information Item and Description

No.	Name	Function
1	Current Version	Displaying the present tool version.
2	MAC Address	Display the MAC address.
3	WAN IP	Display the WAN IP.
4	Zero Config IP	Display the Zero configuration IP.
5	TCP Server Port	Display the TCP server port.
6	Web Server Port	Display the Web server port.

5.3.2 Time/Date

Set the date, time, and holidays of the system.

Time/Date > Time/Date

Set the date, time, and holidays of the system.

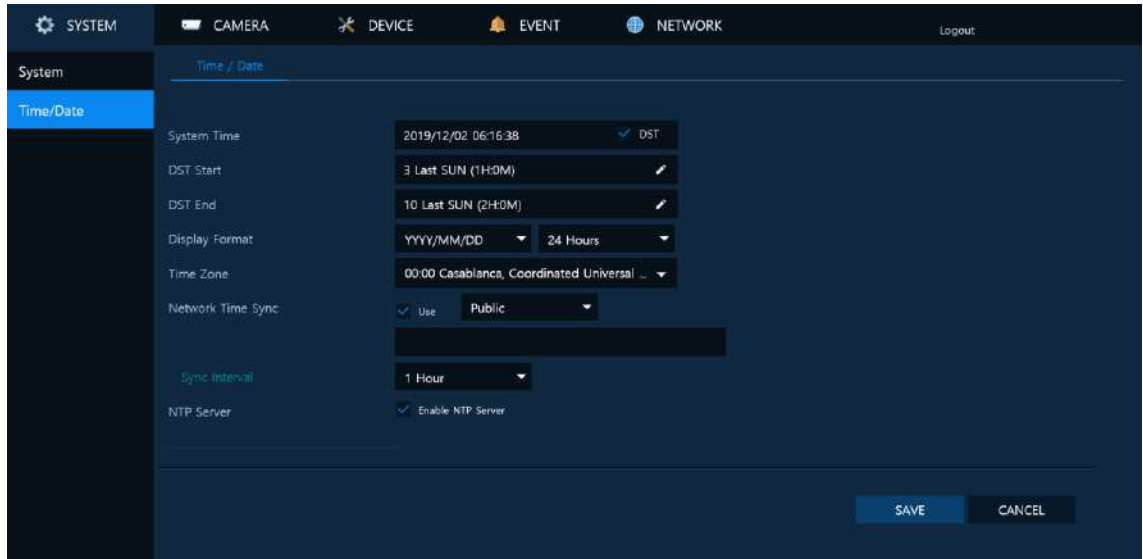

Figure 5-5 SYSTEM > Time/Date > Time/Date

Table 5-5 SYSTEM > Time/Date > Time/Date Item and Description

No.	Name	Function
1	System Time	Set the date and time. <ul style="list-style-type: none"> DST: Select whether to use summer time.
2	DST Start	Set the starting date of summer time
3	DST End	Set the ending date of summer time
4	Display Format	Select the format to present date and time.
5	Time Zone	Select time zone.
6	Network Time Sync	For using a specific network time server, click the Use checkbox and enter the server address. <ul style="list-style-type: none"> Sync. Interval: Select synchronization period (1, 3, 5, 7 Hour)
7	NTP Server	Select whether to use the device as an NTP server.

5.4 CAMERA

In **Camera** section, set the camera to be connected with the device.



5.4.1 Channel Assign

[Channel Assign](#) > [Channel Assign](#)

Display and set the assigned channel.

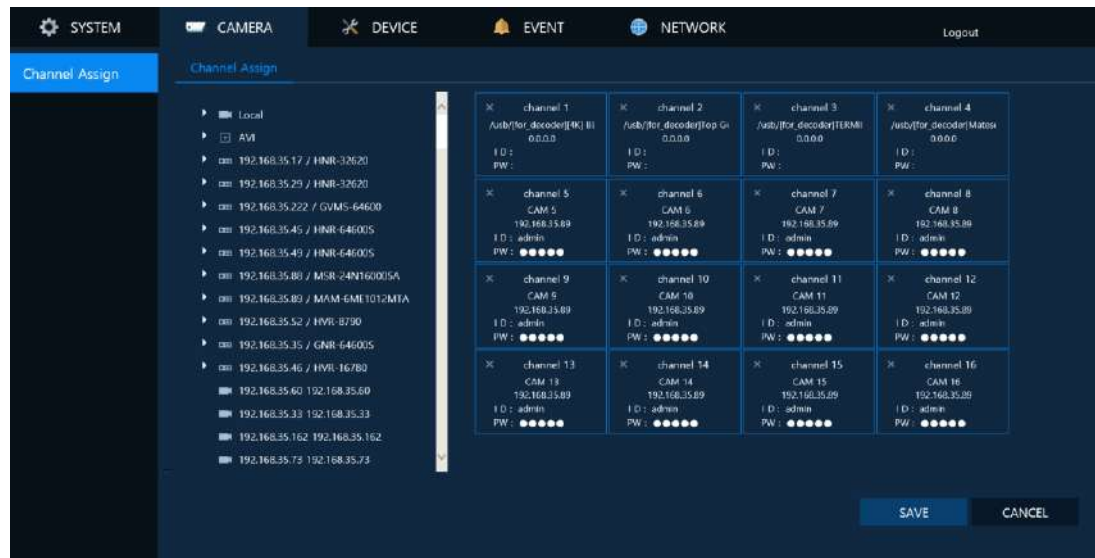

Figure 5-6 CAMERA > Channel Assign > Channel Assign

5.5 DEVICE

In **DEVICE**, set the device to connect with the unit.



5.5.1 Display

Set matters related to a display device and live screen.

[Display](#) > [Display](#)

Set the local display device with Web setting.

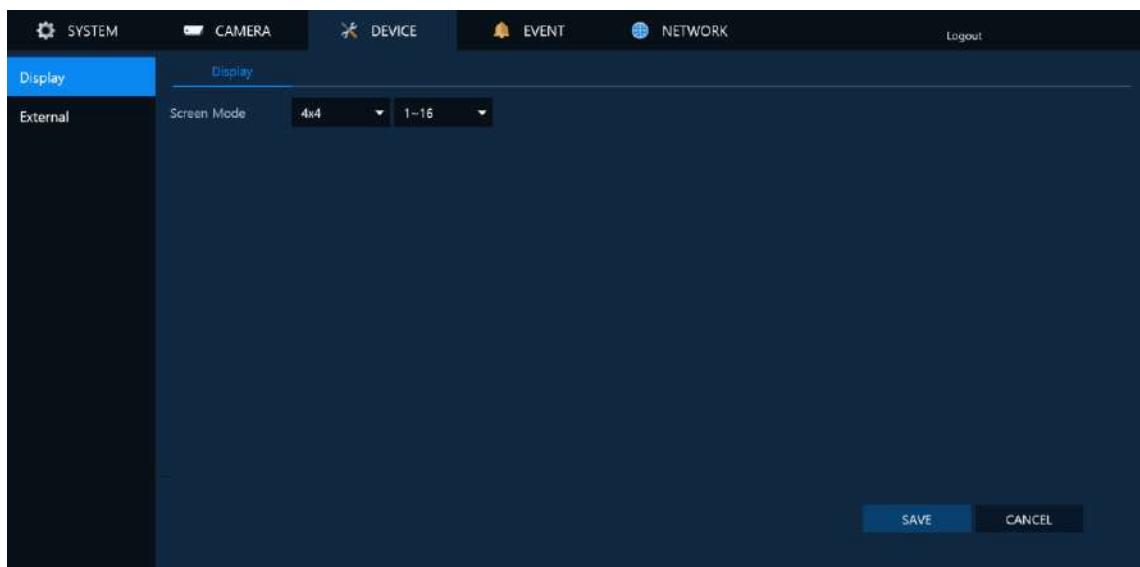

Figure 5-7 DEVICE > Display > Display

Table 5-6 DEVICE > Display > Display Item and Description

No.	Name	Function
1	Screen Mode	Set the screen mode.

5.5.2 External

External > USB

Upload or delete external file via USB

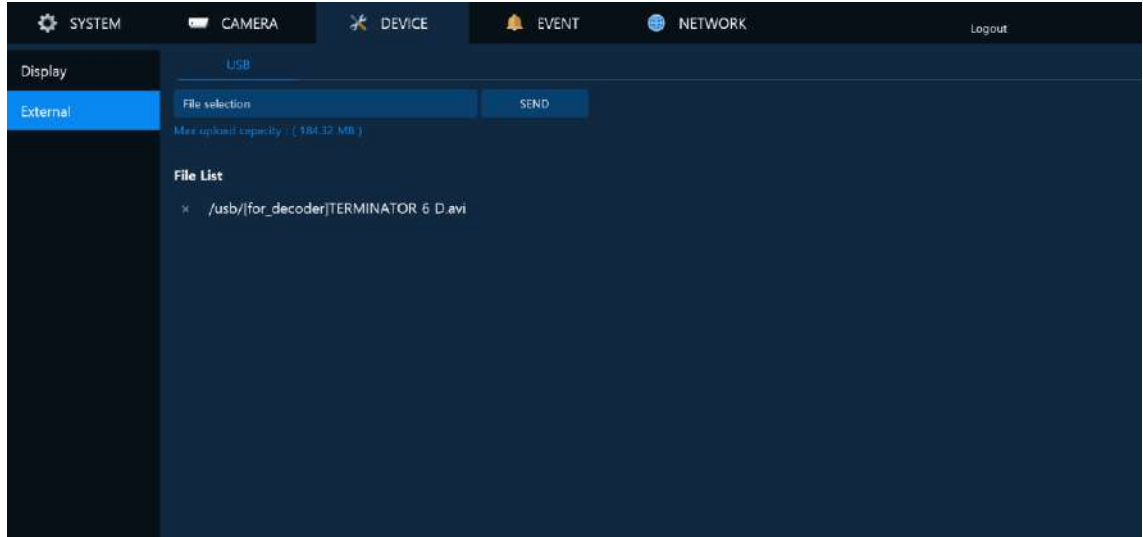

Figure 5-8 DEVICE > External > USB

Table 5-7 DEVICE > Serial Device > Serial Device Item and Description

No.	Name	Function
1	USB (to Serial)	Set communication transmission value of USB device.

5.6 EVENT

In **EVENT**, users may set the event type.



5.6.1 Alarm In

[Alarm In > Setup](#)

Set the sensor alarms.

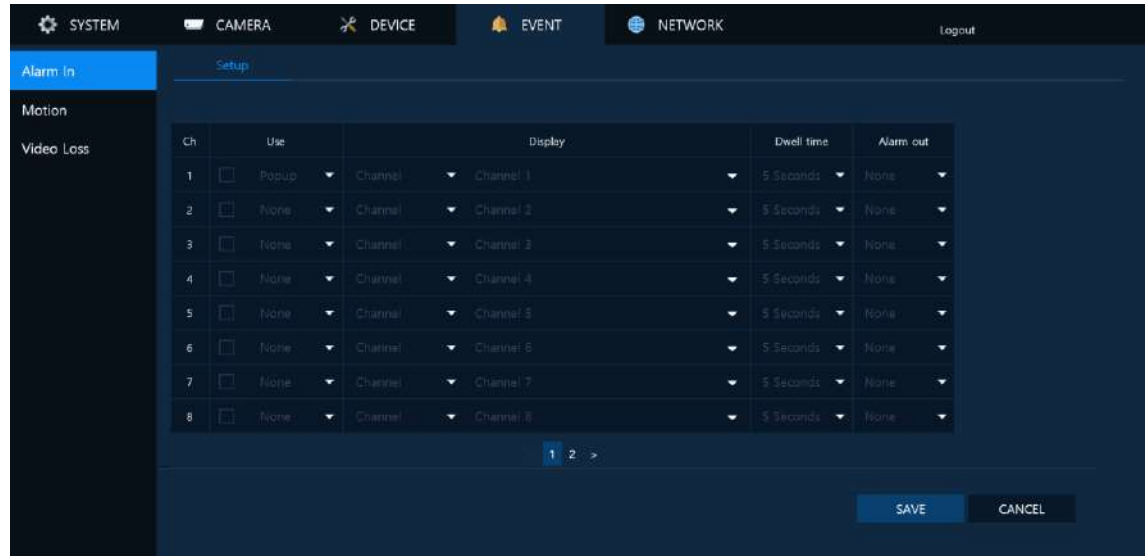

Figure 5-9 Event > Alarm In > Setup

Table 5-8 Event > Alarm In > Setup Item and Description

No.	Name	Function
1	Ch	Display channel.
2	Use	Select/deselect whether to use alarm in the sensor Select the alarm type (None, Popup, PIP).
3	Display	Select channel type and channel number to display.
4	Dwell time	Select alarm duration (5 Seconds ~ 5 Minute).
5	Alarm out	Set the time of alarm out (None, 5 Seconds ~ 5 Minute).

5.6.2 Motion

[Motion > Setup](#)

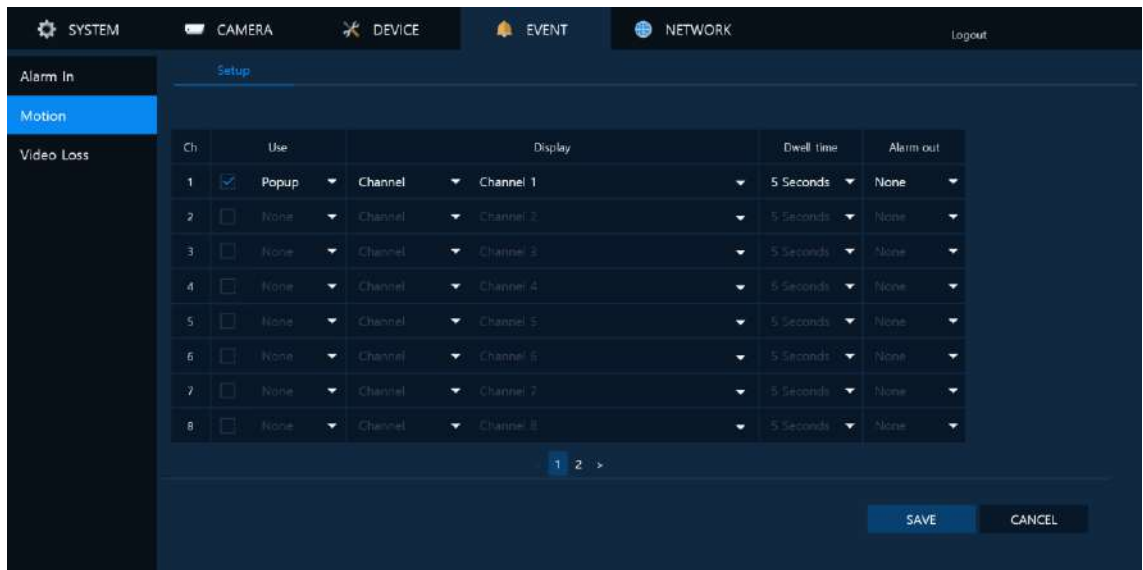

Figure 5-10 Event > Motion > Setup

5.6.3 Video Loss

[Video Loss > Setup](#)

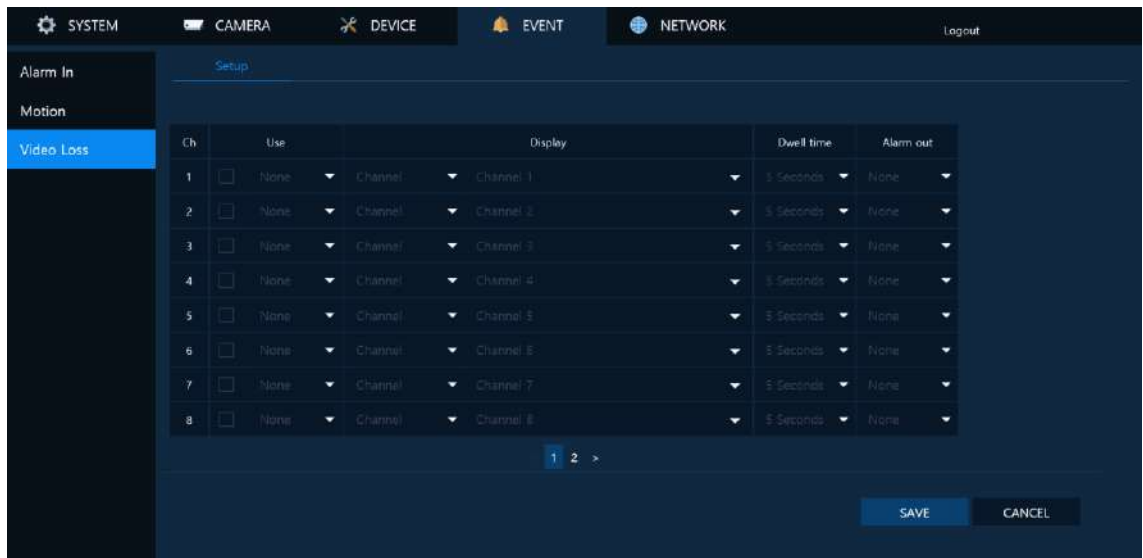

Figure 5-11 Event > Video Loss > Setup

5.7 NETWORK

In **NETWORK**, users may set the network environment.



5.7.1 Basic

Basic > WAN Port

To set the network WAN port.

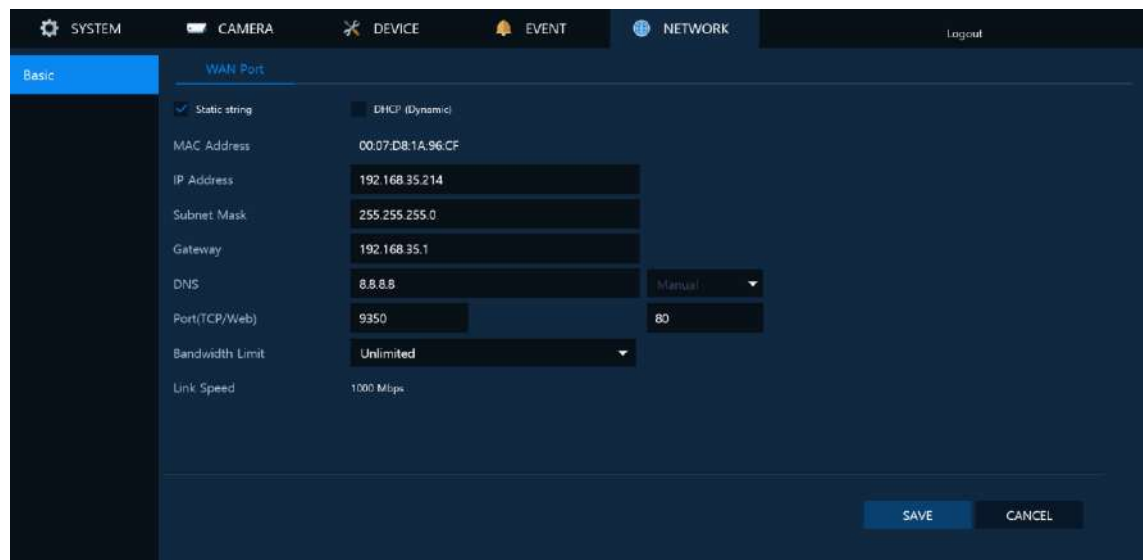

Figure 5-12 NETWORK > Basic > WAN Port

Table 5-9 NETWORK > Basic > WAN Port Item and Description

No.	Name	Function
1	Static string	Check if you use static string. For using static string, enter IP address, Subnet Mask, and Gateway.
2	DHCP (Dynamic)	Select whether to use DHCP (Dynamic).
3	MAC Address	Display the MAC Address.
4	IP Address Subnet Mask Gateway	Enter the each information properly.
5	DNS	Select manual and enter DNS; otherwise choose automatic function.
6	Port(TCP/Web)	Enter the TCP port for TCP. Or enter the Web port for Web.
7	Bandwidth Limit	Select bandwidth to limit (no limits, 50Mbps, 10Mbps, 5Mbps, 2Mbps, 1Mbps, 500Kbps, 400Kbps, 300Kbps, 200Kbps, and 100Kbps).
8	Link Speed	Display linked network speed.

6. Product Specification

Model	Decoder
VIDEO	
Video Input	16ch
Video Input Resolution	Up to 8MP
Compression	H.264, H.265
Media File Play	Max. 4ch
Display Output	1 HDMI, 1 BNC(CVBS)
Display Resolution	HDMI: 3840x2160, 1920x1080 CVBS: NTSC/PAL
Display Speed	HDMI: 400/480fps, CVBS: 25/30fps(PAL/NTSC)
Display Mode	HDMI: 1/4/8/9/10/16 CVBS: 1
NETWORK	
Ethernet	1 RJ45 (10/100/1000 Base-T)
Max. Output Throughput	576Mbps
Remote Monitoring	Web, Smart Manager, CMS, VM
EXTERNAL IN/OUT	
Audio Out	1 RCA, 1 HDMI
Alarm Out	2 Output (Terminal block)
USB	2 USB2.0, 1 USB3.0
SD Card	1 Micro SD(Media File)
ETC	
Operating Humidity	0 ~ 90% RH (Non-condensing)
Operating Temperature	0°C ~ +40°C
Power Supply	12VDC, 2A
Power Consumption	Max. 10W
Dimension(WxHxD)	155x40x102mm
Net Weight	Approx. 0.45Kg

※ Specifications are subject to change without notice.