



FCC SDoC Test Report

Issued date: Sep. 08, 2021

Project No.: 21Q072101

Product : Network Camera

Model : FE9391-EHV-v2, FE931-EHV

Applicant : VIVOTEK INC.

Address : 6F, No.192, Lien-Cheng Rd., Chung-Ho , New Taipei City, 235,
Taiwan, R.O.C.

Report No: WD-EF-R-210267-A0

According to

47 CFR FCC Part 15, Subpart B, Class A

ANSI C63.4: 2014

ANSI C63.4a: 2017

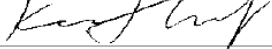
Authorized Signatory :  / Ken Huang

Wendell Industrial Co., Ltd
Wendell EMC & RF Laboratory

Add: 5F-1, No. 188, Baoqiao Road, Xindian District, New Taipei City 23145, Taiwan R.O.C.





Table of Contents

1	Certification	5
1.1	Summary of Test Result.....	6
2	Test Configuration of Equipment Under Test	7
2.1	Test Facility.....	7
2.2	Measurement Uncertainty	8
2.2.1	Conducted Emission test.....	8
2.2.2	Radiated Emission test.....	8
3	General Information.....	9
3.1	Description of EUT.....	9
3.2	Description of Test Modes.....	10
3.3	EUT Operating Condition	11
3.4	Description of Support Unit	12
3.5	Configuration of System Under Test.....	13
4	Emission Test.....	14
4.1	Conducted Emission Measurement	14
4.1.1	Limit of Conducted Emission Measurement	14
4.1.2	Test Instrument	15
4.1.3	Test Procedure.....	16
4.1.4	Deviation from Test Standard	16
4.1.5	Test Setup.....	17
4.1.6	Test Result	18
4.1.7	Photographs of Test Configuration	20
4.2	Radiated Emission Measurement	21
4.2.1	Limits of Radiated Emission Measurement	21
4.2.2	Test Instrument	23
4.2.3	Test Procedure.....	24
4.2.4	Deviation from Test Standard	24
4.2.5	Test Setup.....	25
4.2.6	Test Result	26
4.2.7	Photographs of Test Configuration	34



History of this test report

Report No.	Issue date	Description
WD-EF-R-210267-A0	Sep. 08, 2021	Initial Issue

Declaration

This report is for your exclusive use. Any copying or replication of this report to or for any other person or entity, or use of our name or trademark, is permitted only with our prior written permission. This report sets forth our findings solely with respect to the test samples identified herein. The results set forth in this report are not indicative or representative of the quality or characteristics of the lot from which a test sample was taken or any similar or identical product unless specifically and expressly noted. Our report includes all of the tests requested by you and the results thereof based upon the information that you provided to us.



History of supplementary report

Report No.	Issue date	Description
WD-EF-R-210267-A0	Sep. 08, 2021	Original report

Declaration

This report is for your exclusive use. Any copying or replication of this report to or for any other person or entity, or use of our name or trademark, is permitted only with our prior written permission. This report sets forth our findings solely with respect to the test samples identified herein. The results set forth in this report are not indicative or representative of the quality or characteristics of the lot from which a test sample was taken or any similar or identical product unless specifically and expressly noted. Our report includes all of the tests requested by you and the results thereof based upon the information that you provided to us.



1 Certification

Product: Network Camera

Brand Name: VIVOTEK

Model: FE9391-EHV-v2, FE931-EHV

Applicant: VIVOTEK INC.

Tested: Aug. 11 ~ Aug. 27, 2021

Standard: 47 CFR FCC Part 15, Subpart B, Class A

ANSI C63.4: 2014

ANSI C63.4a: 2017

The above equipment (Model: FE9391-EHV-v2) has been tested by **Wendell EMC & RF Laboratory**, and found compliance with the requirement of the above standards. The test record, data evaluation and Equipment Under Test (EUT) configurations represented herein are true and accurate accounts of the measurements of the sample's EMC characteristics under the conditions specified in this report.

Please note that the measurement uncertainty are provided for informational purpose only and are not used in determining the Pass/Fail results.



1.1 Summary of Test Result

The EUT has been tested according to the following specifications:

Emission				
Standard	Test Item	Limit	Result	Remark
47 CFR FCC Part 15, Subpart B	Conducted disturbance at mains terminals	Class A	Pass	Meets the requirements
	Radiated disturbance	Class A	Pass	Meets the requirements

Note: Test record contained in the referenced test report relate only to the EUT sample and test item.



2 Test Configuration of Equipment Under Test

2.1 Test Facility

Conducted disturbance at mains terminals Test

W01: 5F-1, No.188, Baoqiao Rd., Xindian Dist., New Taipei City 23145, Taiwan (R.O.C)

Conducted disturbance at mains terminals and Radiated emission (9*6*6 Chamber) Tests

W08: No.119, Wugong 3rd Rd., Wugu Dist., New Taipei City 248, Taiwan (R.O.C)

ACCREDITATIONS

The laboratories are accredited and approved by the TAF according to ISO/IEC 17025.

2.2 Measurement Uncertainty

The measurement instrumentation uncertainty is evaluated according to CISPR 16-4-2.

This uncertainty represents an expanded uncertainty expressed at approximately the 95% confidence level using a coverage factor of $k=2$.

Wendell EMC & RF Laboratory U_{lab} is less than U_{cispr} , therefore compliance or non-compliance with a disturbance limit shall be determined in the following manner.

- compliance is deemed to occur if no measured disturbance level exceeds the disturbance limit;
- non-compliance is deemed to occur if any measured disturbance level exceeds the disturbance limit.

Please note that the measurement uncertainty (U_{lab}) is provided for informational purpose only and is not used in determining the Pass/Fail results.

2.2.1 Conducted Emission test

Test Site	Measurement Freq. Range	dB (U_{lab})	Note
W01	150 kHz ~ 30 MHz	2.72	N/A
W08	150 kHz ~ 30 MHz	2.70	N/A

2.2.2 Radiated Emission test

Test Site	Measurement Freq. Range	Ant	dB (U_{lab})	Note
W08	30 MHz ~ 200 MHz	V	3.68	N/A
	30 MHz ~ 200 MHz	H	2.70	N/A
	200 MHz ~ 1000 MHz	V	5.19	N/A
	200 MHz ~ 1000 MHz	H	3.26	N/A
	1 GHz ~ 6 GHz	V	4.98	N/A
	1 GHz ~ 6 GHz	H	5.07	N/A
	6 GHz ~ 18 GHz	V	5.09	N/A
	6 GHz ~ 18 GHz	H	4.99	N/A
	18 GHz ~ 40 GHz	V	4.72	N/A
	18 GHz ~ 40 GHz	H	4.72	N/A



3 General Information

3.1 Description of EUT

Product	Network Camera
Brand	VIVOTEK
Model	FE9391-EHV-v2, FE931-EHV
Applicant	VIVOTEK INC.
Received Date	Jul. 21, 2021
EUT Power Rating	12Vdc (from AC-DC adapter) or 55Vdc (from PoE injector)
Model Differences	The models are electrically identical, different models no. are for marketing purpose. This series model information is provided by client.
Operating System	N/A
Data Cable Supplied	N/A
Accessory Device	N/A
I/O Port	Please refer to the User's Manual

Note:

1. The EUT's highest operating frequency is 1866MHz. Therefore the radiated emission is tested up to 10GHz.

3.2 Description of Test Modes

For conducted emission, the EUT has been pre-tested under the following test modes, and **test mode 1** was the worst case for final test.

Test Mode	Test Condition
1	AC-DC adapter mode (IR ON)
2	AC-DC adapter mode (IR OFF)

For radiated emission, the EUT has been pre-tested under the following test modes, and **test mode 1 and 3** were the worst case for final test.

Test Mode	Test Condition
1	AC-DC adapter mode (IR ON)
2	AC-DC adapter mode (IR OFF)
3	PoE mode (IR ON)
4	PoE mode (IR OFF)

Test results are presented in the report as below.

Test Mode	Test Condition
Conducted emission test	
-	AC-DC adapter mode (IR ON)
Radiated emission 30MHz ~ 1GHz test	
A	AC-DC adapter mode (IR ON)
B	PoE mode (IR ON)
Radiated emission above 1GHz test	
A	AC-DC adapter mode (IR ON)
B	PoE mode (IR ON)

3.3 EUT Operating Condition

Adapter mode

- a. Placed the EUT on the test table.
- b. Prepare PC to act as a communication partner and placed it outside of testing area.
- c. The EUT was connected to the PC with LAN cable.
- d. The communication partner sent data to EUT by command “ping” via LAN.
- e. The EUT sent video signal to PC via LAN cable.
- f. The microphone sent voice signal to EUT.
- g. The EUT sent voice signal to earphone.
- h. The EUT write data with Micro SD card.

PoE mode

- a. Placed the EUT on the test table.
- b. Prepare PC and PoE injector to act as a communication partner and placed it outside of testing area.
- c. The EUT was connected to PC via LAN and PoE.
- d. The communication partner sent data to EUT by command “ping” via LAN.
- e. The EUT sent video signal to PC via LAN cable.
- f. The microphone sent voice signal to EUT.
- g. The EUT sent voice signal to earphone.
- h. The EUT write data with Micro SD card.



3.4 Description of Support Unit

The EUT has been conducted testing with other necessary accessories or support units.

Item	Equipment	Brand	Model No.	Serial No.	FCC ID	Data Cable	Power Cord	Remark
1	Desktop PC	DELL	D13M	H6K10 A00	FCC DoC Approved	20m CAT.5E non-shielded RJ45 cable (for adapter mode) 1m CAT.5E non-shielded RJ45 cable (for PoE mode)	1.8m non-shielded cable	-
2	PoE injector	Microsemi	PD-9601G/AC	N/A	N/A	20m CAT.5E non-shielded RJ45 cable	1.8m non-shielded cable	-
3	Earphone & microphone	E-books	E-EPA057	N/A	N/A	1.4m non-shielded cable	N/A	-
4	Micro SD card	ADATA	32GB	N/A	N/A	N/A	N/A	-
5	Grounding wire	N/A	N/A	N/A	N/A	1m non-shielded cable	N/A	-

- Note:**
1. The core(s) is(are) originally attached to the cable(s).
 2. Item 1-2 acted as communication partners to transfer data.
 3. The EUT uses the follow adapter and PoE injector:

AC-DC adapter (support unit only)	
Brand	SPC
Model	ZZU1588-200120-2A
Input Power	100-240Vdc, 1.5A, 50-60Hz
Output Power	12Vdc, 2A
Power line	Output: 1.8m non-shielded cable

PoE injector (support unit only)	
Brand	Microsemi
Model	PD-9601G/AC
Input Power	100-240Vdc, 1.35A, 50/60Hz
Output Power	55Vdc, 1.75A
Power line	1.8m non-shielded cable

3.5 Configuration of System Under Test

Adapter mode

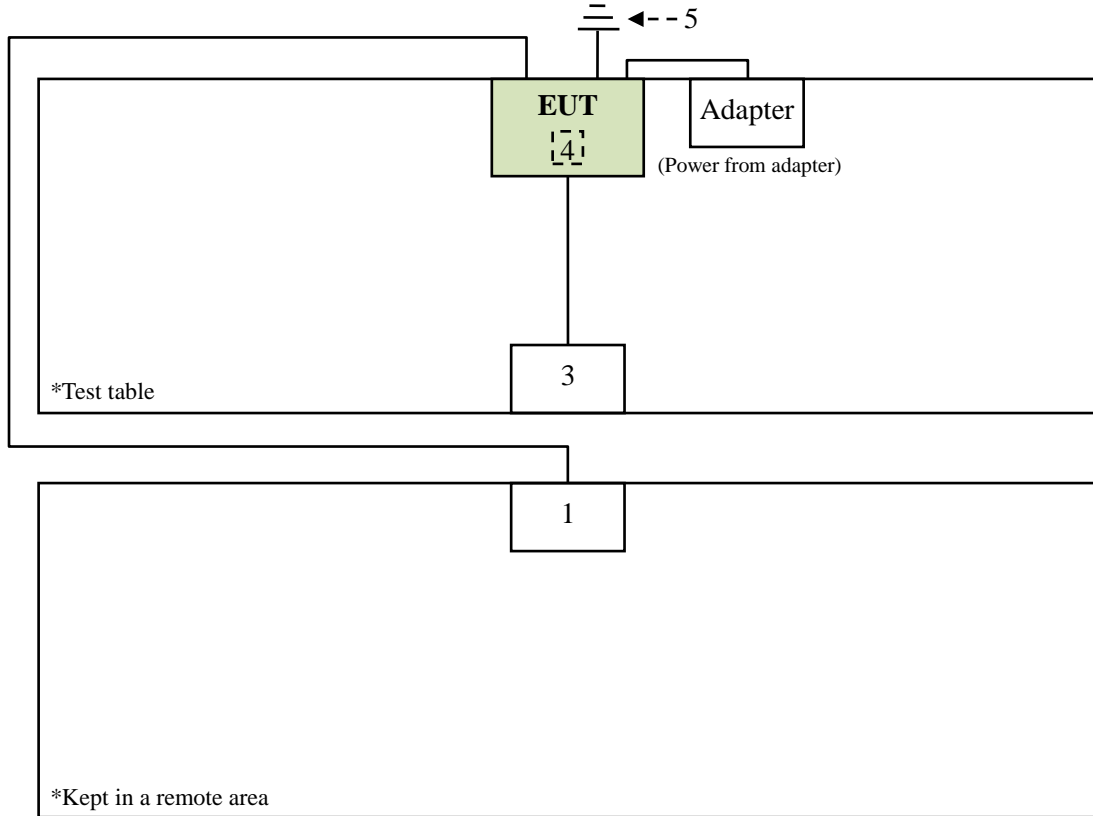

PoE mode

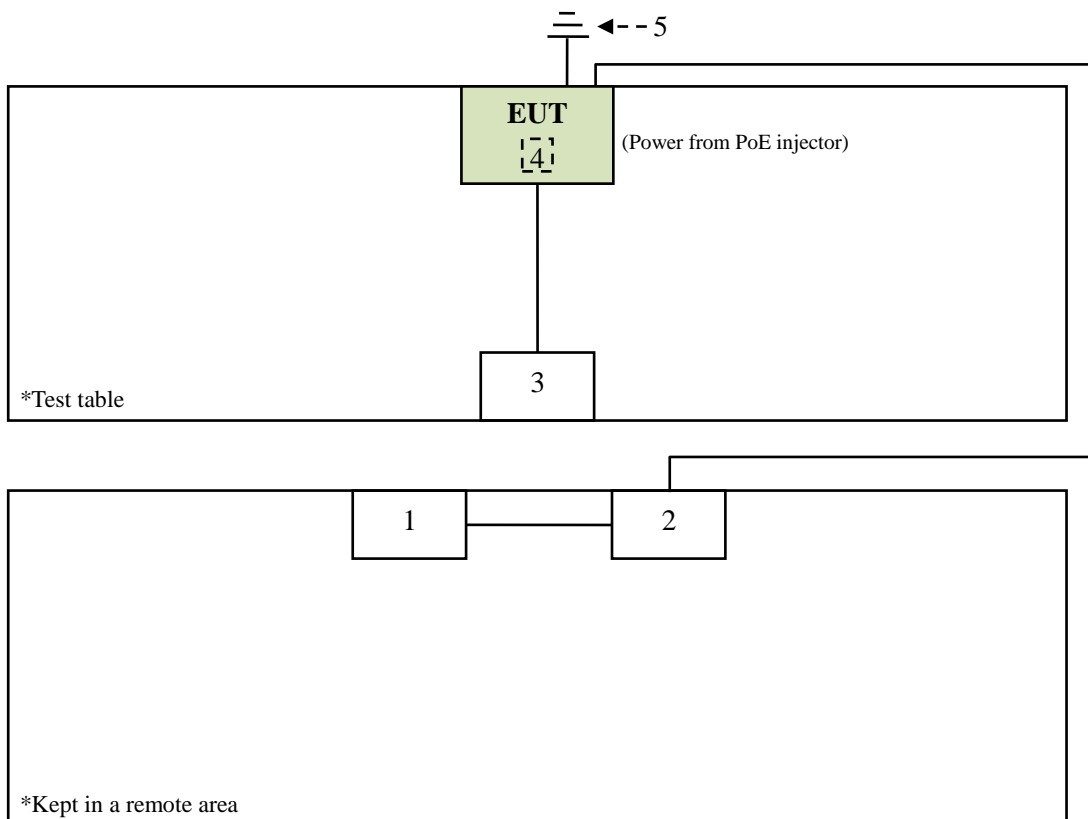



4 Emission Test

4.1 Conducted Emission Measurement

4.1.1 Limit of Conducted Emission Measurement

Frequency (MHz)	Class A (dB μ V)		Class B (dB μ V)	
	Quasi-peak (dB μ V)	Average (dB μ V)	Quasi-peak (dB μ V)	Average (dB μ V)
0.15 - 0.5	79	66	66 to 56	56 to 46
0.5 - 5	73	60	56	46
5 - 30	73	60	60	50

- Note:**
1. The lower limit shall apply at the transition frequencies.
 2. The limit decreases in line with the logarithm of the frequency in the range of 0.15 to 0.50 MHz.
 3. Detector function in the form: PK = Peak, QP = Quasi Peak, AV = Average
 4. The test result calculated as following:
Measurement Value = Reading Level + Correct Factor
Correction Factor = Insertion loss of LISN + Cable loss + Transient Limiter (If use)
Margin Level = Measurement Value – Limit Value



4.1.2 Test Instrument

Test Site: W01-CE					
Item	Equipment	Manufacturer	Model	Meter No.	Calibration Date
1	TWO-LINE V-NETWORK	R&S	ENV216	CT-1-025-1	May 30, 2021
2	Pulse limiter	R&S®	ESH3-Z2	CT-2-015	May 27, 2021
3	EMI Test Receiver	R&S	ESCI	CT-1-024	May 24, 2021
4	V-LISN	SCHWARZBECK	NSLK8127	CT-1-104-1	May 30, 2021
5	Test Cable	Marvelous Microwave Inc	200200.400LL .500A	CT-10-048-1	May 27, 2021
6	50ohm Termination	N/A	N/A	CT-1-065-1	May 31, 2021
7	Measurement Software	EZ-EMC	Ver: EMC-CON 3A1	CT-3-012	No calibration request

Note: 1. The calibration interval of the above test instruments is 12 months.

Test Site: W08-CE					
Item	Equipment	Manufacturer	Model	Meter No.	Calibration Date
1	TWO-LINE V-NETWORK LISN	R&S®	ENV216	CT-1-025-2	Jun. 11, 2021
2	Test Cable	EMCI	EMCCFD300-BM-BM-5000	CT-1-107-2	Jun. 10, 2021
3	EMI Test Receiver	R&S	ESR3	CT-1-103	Jun. 08, 2021
4	LISN	SCHWARZBECK	NSLK 8127RC	CT-1-104-1RC	Jun. 11, 2021
5	Transient Limiter	EM Electronics Corporation	EM-7600	CT-1-026	Jun. 10, 2021
6	50ohm Termination	HUBER+SUHNER	N/A	CT-1-109-1	Jun. 11, 2021
7	Measurement Software	EZ-EMC	Ver: EMC-CON 3A1	CT-3-012	No calibration request

Note: 1. The calibration interval of the above test instruments is 12 months.

4.1.3 Test Procedure

- a. The table-top EUT was placed 0.8 meter height wooden table from the horizontal ground plane with EUT being connected to power source through a line impedance stabilization network (LISN). The LISN at least be 80 cm from nearest chassis of EUT. The floor-standing EUT and all cables shall be insulated from the ground plane by up to 12 mm of insulating material if required.
- b. The line impedance stabilization network (LISN) provides 50 ohm/50uH of coupling impedance for the measuring instrument. All other support equipments powered from additional LISN(s).
- c. Interrelating cables that hang closer than 40 cm to the ground plane shall be folded back and forth in the center forming a bundle. All I/O cables were positioned to simulate typical usage.
- d. All I/O cables that are not connected to a peripheral shall be bundle in the center. The end of the cable may be terminated, if required, using the correct terminating impedance. The overall length shall not exceed 1 m.
- e. The EMI test receiver connected to LISN powering the EUT. The actual test configuration, please refer to EUT test photos.
- f. The receiver scanned from 150kHz to 30MHz for emissions in each of test modes. A scan was taken on both power lines, Line and Neutral, recording at least six highest emissions.
- g. The EUT and cable configuration of the above highest emission levels were recorded. The test data of the worst case was recorded.

4.1.4 Deviation from Test Standard

No deviation

4.1.5 Test Setup

< Table-Top equipment >

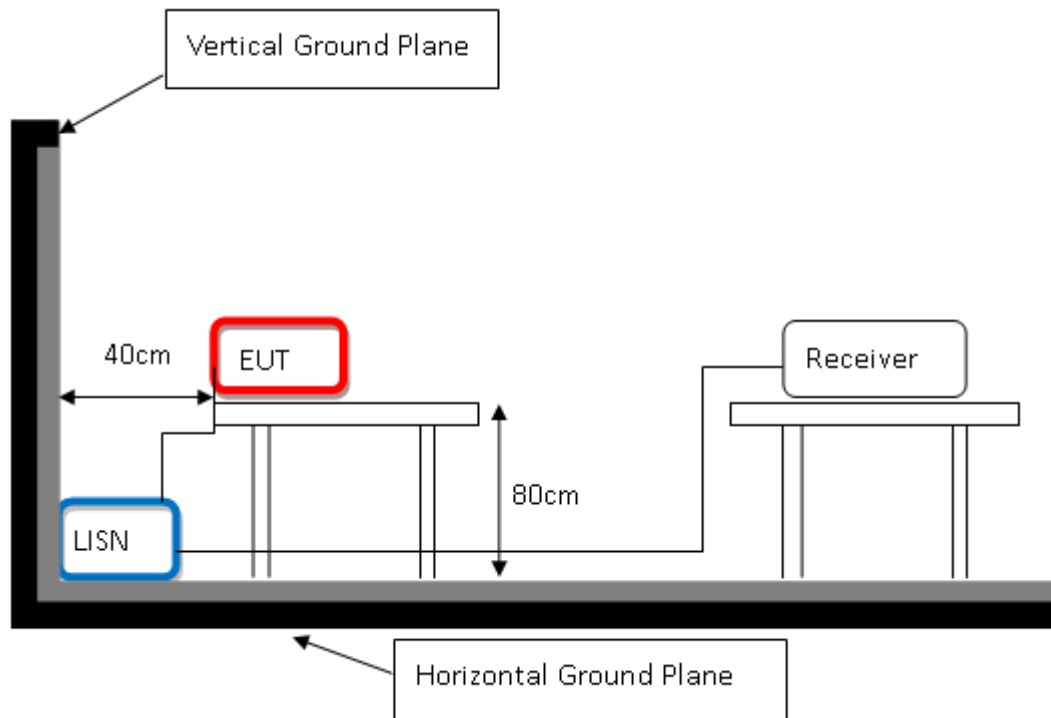

< Floor-Standing equipment >

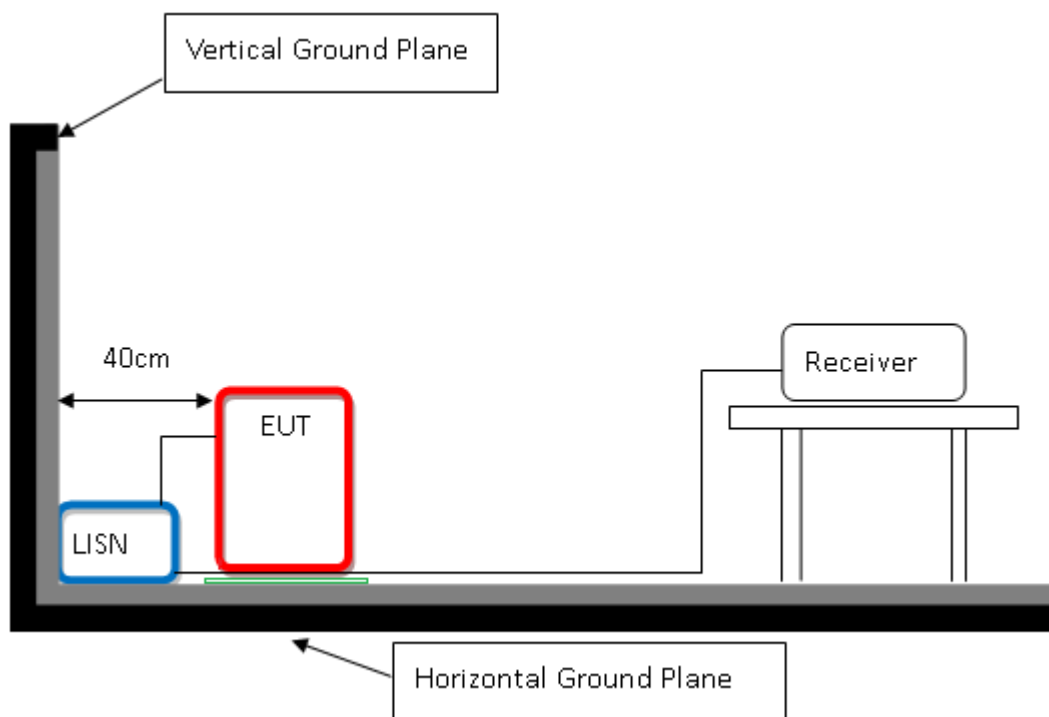

Note: Please refer to 4.1.7 for the actual test configuration.



4.1.6 Test Result

Test Voltage	120Vac, 60Hz	Frequency Range	0.15-30 MHz
Environmental Conditions	24.6°C, 50% RH	6dB Bandwidth	9 kHz
Test Date	2021/08/11	Phase	L
Tested by	Guanwei Liao	Test Site	W01

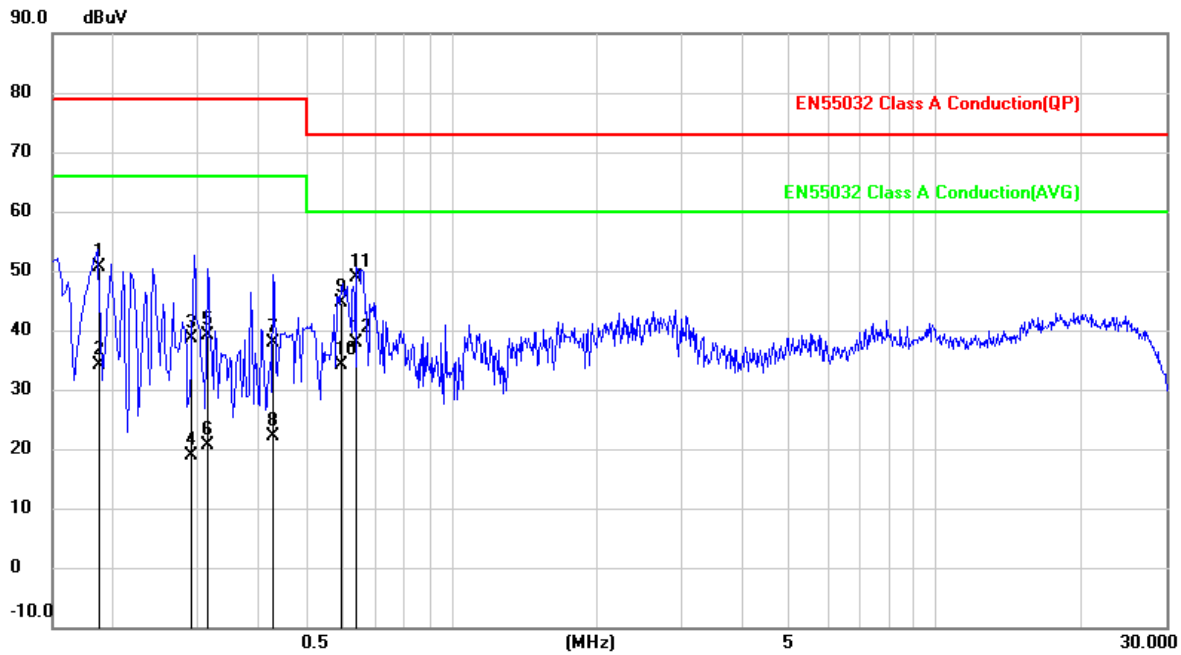

No.	Frequency (MHz)	Reading Level (dBμV)	Correct Factor (dB)	Measurement (dBμV)	Limit (dBμV)	Margin (dB)	Detector
1	0.1878	40.78	9.96	50.74	79.00	-28.26	QP
2	0.1878	24.19	9.96	34.15	66.00	-31.85	AVG
3	0.2906	28.63	9.96	38.59	79.00	-40.41	QP
4	0.2906	8.94	9.96	18.90	66.00	-47.10	AVG
5	0.3140	29.13	9.97	39.10	79.00	-39.90	QP
6	0.3140	10.60	9.97	20.57	66.00	-45.43	AVG
7	0.4296	27.94	9.98	37.92	79.00	-41.08	QP
8	0.4296	12.03	9.98	22.01	66.00	-43.99	AVG
9	0.5895	34.53	9.98	44.51	73.00	-28.49	QP
10	0.5895	24.25	9.98	34.23	60.00	-25.77	AVG
11	0.6393	38.98	9.99	48.97	73.00	-24.03	QP
12	0.6393	27.98	9.99	37.97	60.00	-22.03	AVG

Remark: 1. QP = Quasi Peak, AVG = Average
 2. Correction Factor = Insertion loss of LISN + Cable loss + Transient Limiter (If use)
 3. Measurement Value = Reading Level + Correct Factor
 4. Margin Level = Measurement Value - Limit Value



Test Voltage	120Vac, 60Hz	Frequency Range	0.15-30 MHz
Environmental Conditions	24.6°C, 50% RH	6dB Bandwidth	9 kHz
Test Date	2021/08/11	Phase	N
Tested by	Guanwei Liao	Test Site	W01

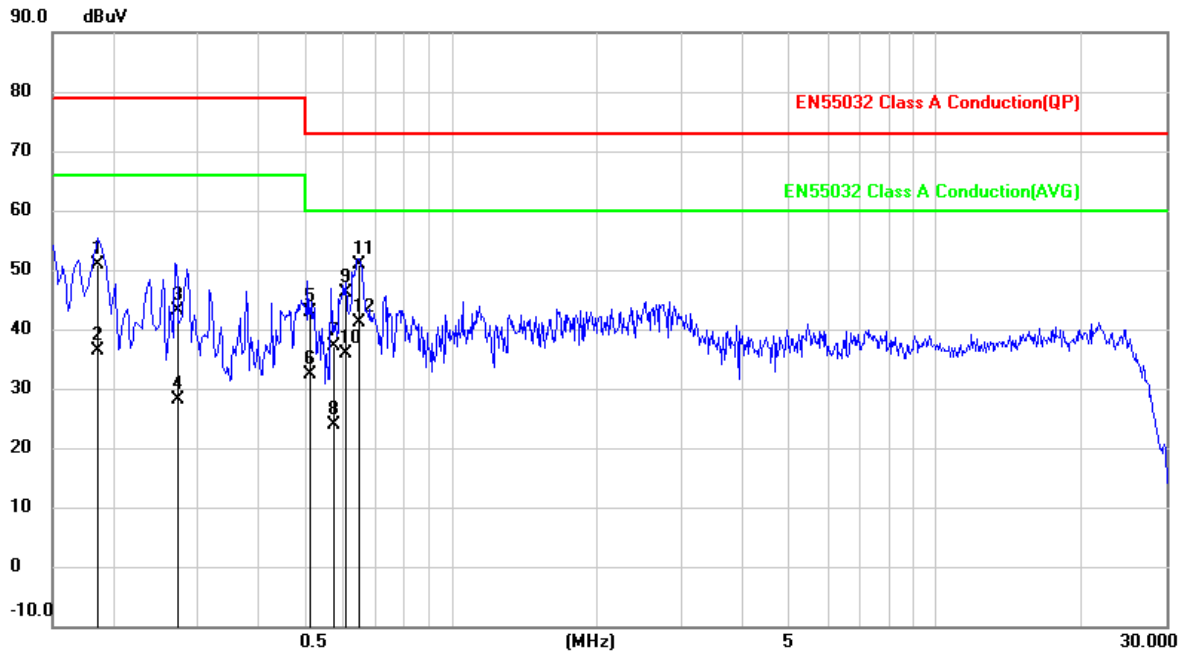

No.	Frequency (MHz)	Reading Level (dBμV)	Correct Factor (dB)	Measurement (dBμV)	Limit (dBμV)	Margin (dB)	Detector
1	0.1853	40.99	9.98	50.97	79.00	-28.03	QP
2	0.1853	26.44	9.98	36.42	66.00	-29.58	AVG
3	0.2725	33.22	9.98	43.20	79.00	-35.80	QP
4	0.2725	18.11	9.98	28.09	66.00	-37.91	AVG
5	0.5081	32.81	9.99	42.80	73.00	-30.20	QP
6	0.5081	22.34	9.99	32.33	60.00	-27.67	AVG
7	0.5726	27.21	10.00	37.21	73.00	-35.79	QP
8	0.5726	13.91	10.00	23.91	60.00	-36.09	AVG
9	0.6013	36.13	10.00	46.13	73.00	-26.87	QP
10	0.6013	25.99	10.00	35.99	60.00	-24.01	AVG
11	0.6461	40.77	10.01	50.78	73.00	-22.22	QP
12	0.6461	31.21	10.01	41.22	60.00	-18.78	AVG

Remark: 1. QP = Quasi Peak, AVG = Average
 2. Correction Factor = Insertion loss of LISN + Cable loss + Transient Limiter (If use)
 3. Measurement Value = Reading Level + Correct Factor
 4. Margin Level = Measurement Value - Limit Value

4.1.7 Photographs of Test Configuration

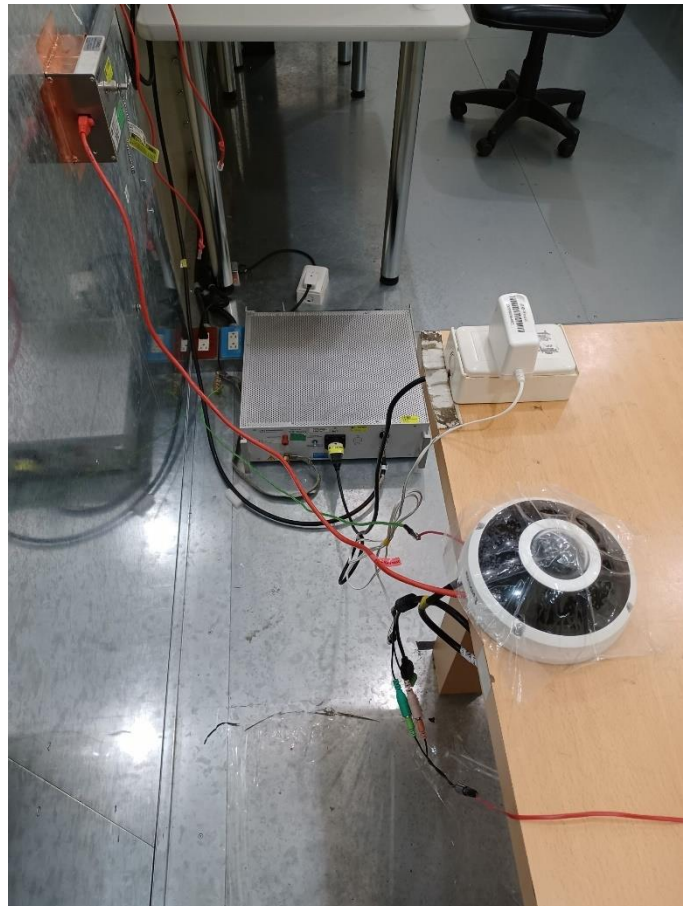



4.2 Radiated Emission Measurement

4.2.1 Limits of Radiated Emission Measurement

Radiated Frequency range 30 MHz to 1000 MHz

FCC 15B Radiated Emissions Limits				
Frequency range (MHz)	Class A (3m) Quasi-peak (dB μ V/m)	Class A (10m) Quasi-peak (dB μ V/m)	Class B (3m) Quasi-peak (dB μ V/m)	Class B (10m) Quasi-peak (dB μ V/m)
30 - 88	49.5	39.1	40	29.5
88 - 216	54	43.5	43.5	33.1
216 - 230	56.9	46.4	46	35.6
230 - 960				
960 - 1000	60	49.5	54	43.5

- Note:**
1. The lower limit shall apply at the transition frequency.
 2. Detector function in the form: PK = Peak, QP = Quasi Peak, AV = Average
 3. The test result calculated as following:
Measurement Value = Reading Level + Correct Factor
Correction Factor = Antenna factor + Cable loss (Antenna to preamplifier) - preamplifier Gain
+ Cable loss (preamplifier to receiver)
Margin Level = Measurement Value - Limit Value

**Radiated Frequency range above 1 GHz**

FCC 15B Radiated Emissions Limits				
Frequency range (GHz)	Class A (3m) (dBμV/m)		Class B (3m) (dBμV/m)	
	Peak	Average	Peak	Average
1 - 40	80	60	74	54

Note: 1. The lower limit shall apply at the transition frequency.

2. Detector function in the form: PK = Peak, QP = Quasi Peak, AV = Average

3. The test result calculated as following:

Measurement Value = Reading Level + Correct Factor

Correction Factor = Antenna factor + Cable loss (Antenna to preamplifier) - preamplifier Gain
+ Cable loss (preamplifier to receiver)

Margin Level = Measurement Value - Limit Value

Frequency Range (For unintentional radiators)

Highest frequency generated or used in the device or on which the device operates or tunes (MHz)	Upper frequency of measurement range (MHz)
Below 1.705	30
1.705-108	1000
108-500	2000
500-1000	5000
Above 1000	5th harmonic of the highest frequency or 40GHz, whichever is lower



4.2.2 Test Instrument

Test Site: W08-966					
Item	Equipment	Manufacturer	Model	Meter No.	Calibration Date
1	Horn Antenna	Schwarzbeck	BBHA 9120D	CT-9-031	Jul. 28, 2021
2	Horn Antenna	Schwarzbeck	BBHA 9170	CT-9-032	Dec. 03, 2020
3	TRILOG Broadband Antenna with 5 dB Attenuator	Schwarzbeck	VULB 9168 & FAT-NM5NF5T3G 2W5	CT-1-002-1	Jul. 29, 2021
4	EXA Signal Analyzer	Keysight	N9010A	CT-1-093	Jul. 28, 2021
5	EMI Test Receiver	Keysight	N9038A	CT-9-007	Jul. 28, 2021
6	Preamplifier	EM	EM 330	CT-9-024	Jul. 30, 2021
7	Preamplifier	SGH & MCL	SGH118 & BW-S15W2+	CT-9-071	May 21, 2021
8	Preamplifier	EMCI	EMC184045SE	CT-9-013	Sep. 04, 2020
9	Test Cable	EMCI	EMCCFD400-NM-NM-1000	CT-1-132	Jul. 29, 2021
10	Test Cable	PEWC	CFD400NL-LW-N M-NM-3000	CT-1-141	Jul. 30, 2021
11	Test Cable	EMCI	EMCCFD400-NM-NM-15000	CT-1-133	Jul. 30, 2021
12	Test Cable	EMCI	EMC104-SM-35M-600	CT-1-134	Jul. 30, 2021
13	Test Cable	MVE	280280.LL266.1400	CT-9-072	May 26, 2021
14	Test Cable	EMCI	EMC102-KM-KM-600	CT-1-136	Jul. 30, 2021
15	Test Cable	MVE	140140.LL404.700	CT-9-066	Jul. 30, 2021
16	Measurement Software	EZ-EMC	Ver : FA-03A2 RE	CT-3-012	No calibration request

Note: 1. The calibration interval of the above test instruments is 12 months.



4.2.3 Test Procedure

- a. The table-top EUT was placed on the top of a turntable 0.8 meters above the ground at 3 m 966 chamber. The floor-standing EUT and all cables shall be insulated from the ground plane by up to 12 mm of insulating material if required. The table was rotated 360 degrees to determine the position of the high radiation emissions.
- b. The height of the test antenna shall vary between 1 m to 4 m. Both vertical and horizontal polarizations of the antenna were set to make the measurement.
- c. The EUT was set up as per the test configuration to simulate typical usage per the user's manual. All I/O cables were positioned to simulate typical usage. The actual test configuration, please refer to EUT test photos.
- d. The initial step in collecting radiated emission data is a Spectrum Mode scanning the measurement frequency range.

Below 1GHz:

Reading in which marked as QP or Peak means measurements by using Spectrum Mode with detector RBW=120kHz.

If the Spectrum Mode measured peak value compliance with and lower than Quasi Peak Limit, the EUT shall be deemed to meet QP Limits.

Above 1GHz:

Reading in which marked as Peak & AVG means measurements by using Spectrum Mode with setting in RBW=1MHz.

If the Spectrum Mode measured value compliance with the Peak Limits and lower than AVG Limits, the EUT shall be deemed to meet both Peak and AVG Limits.

- e. Emission frequency and amplitude were recorded, recording at least six highest emissions. The EUT and cable configuration of the above highest emission levels were recorded. The test data of the worst case was recorded.

4.2.4 Deviation from Test Standard

No deviation

4.2.5 Test Setup

< Radiated Emissions Frequency: 30 MHz to 1000 MHz >

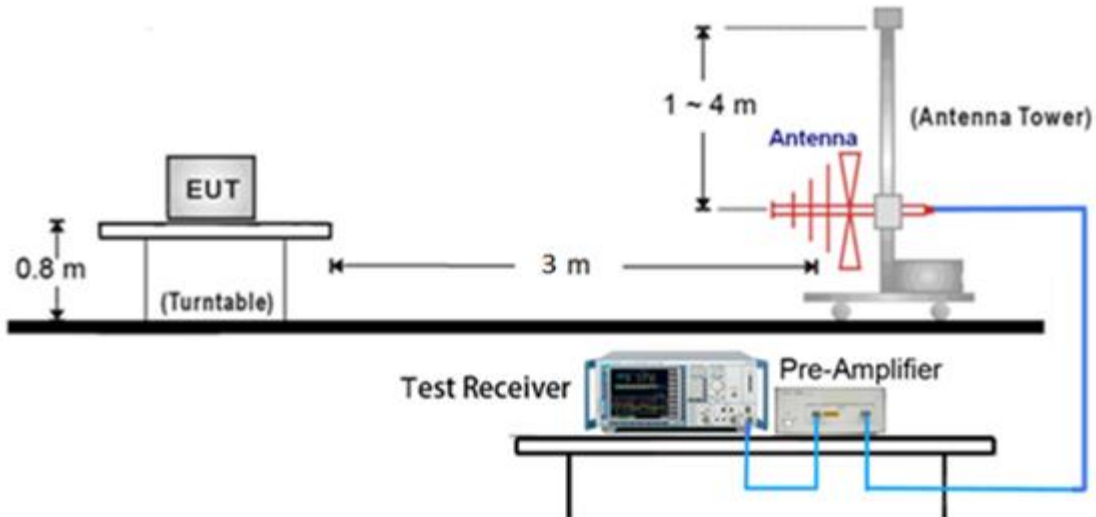

< Radiated Emissions Frequency: above 1GHz >

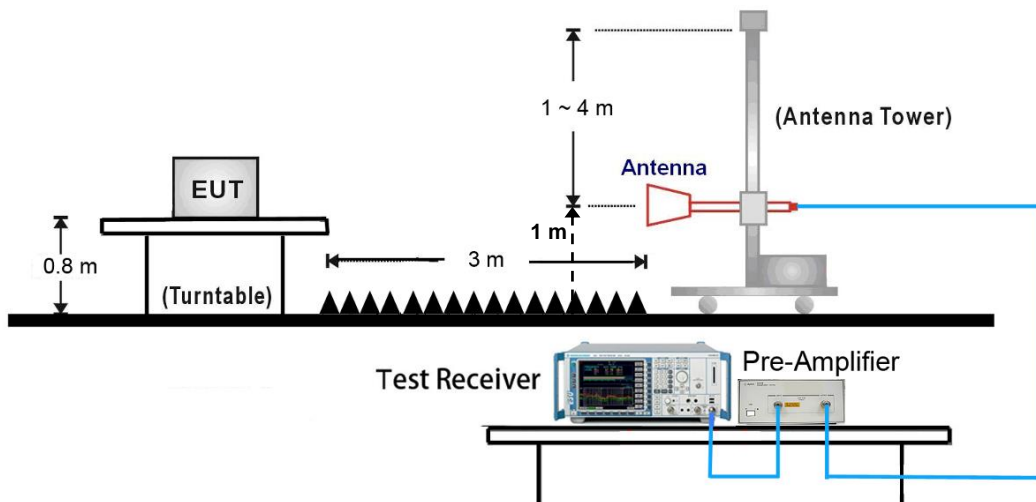

Note:

- (1) Please refer to the 4.2.7 for the actual test configuration.
- (2) The formula of measured value as: $\text{Test Result} = \text{Reading} + \text{Correction Factor}$
- (3) Detector function in the form: PK = Peak, QP = Quasi Peak, AV = Average
- (4) The test result calculated as following:
 $\text{Measurement Value} = \text{Reading Level} + \text{Correct Factor}$
 $\text{Correct Factor} = \text{Antenna Factor} + \text{Cable Loss} - \text{Amplifier Gain (if use)}$
 $\text{Margin Level} = \text{Measurement Value} - \text{Limit Value}$



4.2.6 Test Result

Test Voltage	120Vac, 60Hz	Frequency Range	30 – 1000 MHz
Environmental Conditions	22°C, 41% RH	6dB Bandwidth	120 kHz
Test Date	2021/08/26	Test Distance	3m
Tested by	Karwin Kao	Polarization	Vertical
Test Site	W08	Test mode	A

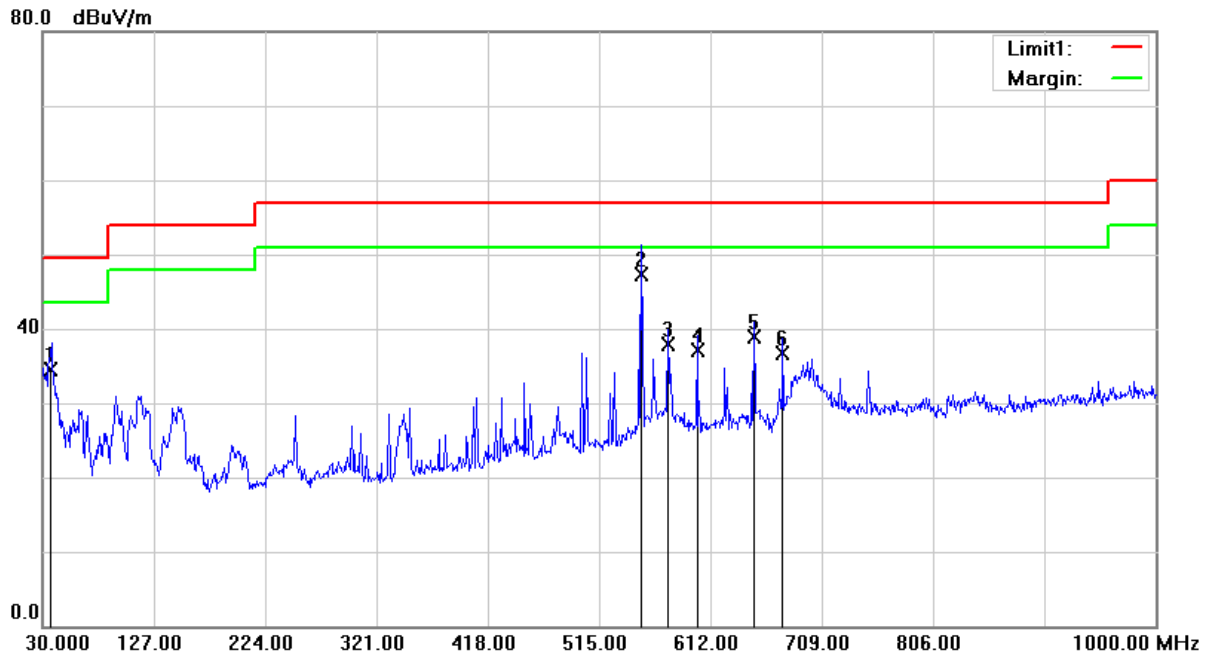

No.	Frequency (MHz)	Reading Level (dBμV)	Correct Factor (dB/m)	Measurement (dBμV/m)	Limit (dBμV/m)	Margin (dB)	Table Degree (degree)	Antenna Height (cm)	Detector
1	37.3750	44.08	-9.66	34.42	49.50	-15.08	161	100	QP
2	551.9950	50.11	-2.86	47.25	56.90	-9.65	178	100	QP
3	575.1400	40.24	-2.34	37.90	56.90	-19.00	172	100	QP
4	600.3600	38.81	-1.67	37.14	56.90	-19.76	340	100	QP
5	649.8300	39.96	-1.11	38.85	56.90	-18.05	360	100	QP
6	675.0500	37.28	-0.62	36.66	56.90	-20.24	199	100	QP

Remark:

1. QP = Quasi Peak
2. Correction Factor = Antenna factor + Cable loss (Antenna to preamplifier) - preamplifier Gain + Cable loss (preamplifier to receiver)
3. Measurement Value = Reading Level + Correct Factor
4. Margin Level = Measurement Value - Limit Value



Test Voltage	120Vac, 60Hz	Frequency Range	30 – 1000 MHz
Environmental Conditions	22°C, 41% RH	6dB Bandwidth	120 kHz
Test Date	2021/08/26	Test Distance	3m
Tested by	Karwin Kao	Polarization	Horizontal
Test Site	W08	Test mode	A

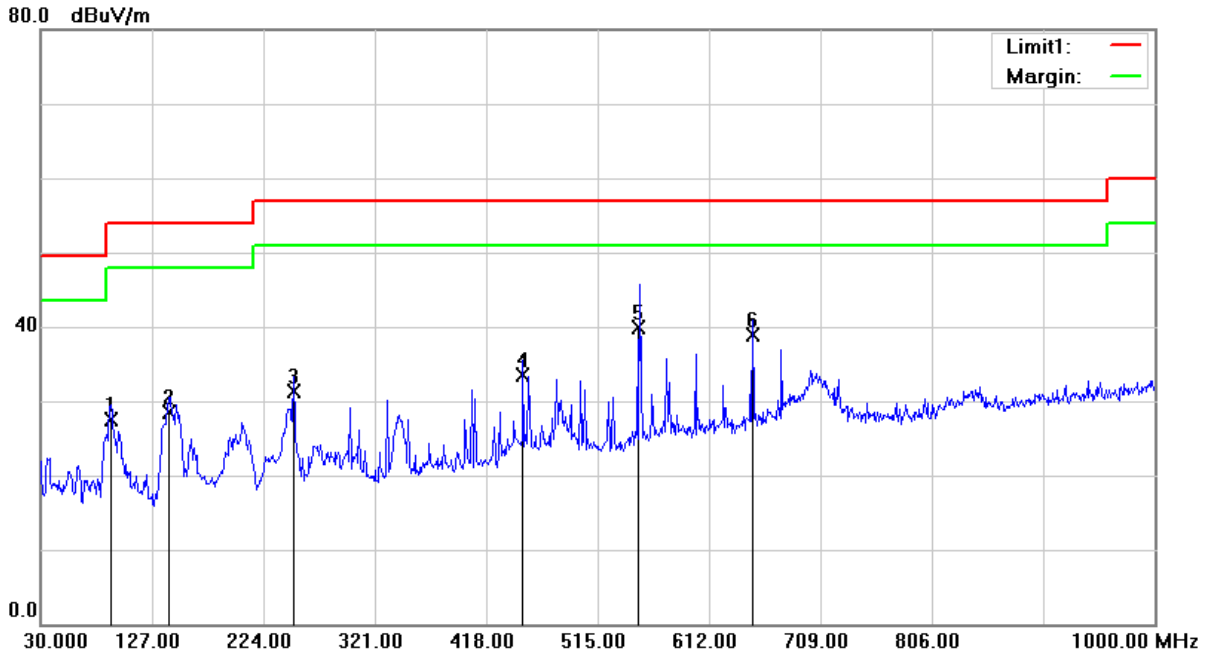

No.	Frequency (MHz)	Reading Level (dBμV)	Correct Factor (dB/m)	Measurement (dBμV/m)	Limit (dBμV/m)	Margin (dB)	Table Degree (degree)	Antenna Height (cm)	Detector
1	91.1100	43.64	-16.04	27.60	54.00	-26.40	72	200	QP
2	141.5500	38.01	-9.45	28.56	54.00	-25.44	287	200	QP
3	250.1900	39.26	-7.96	31.30	56.90	-25.60	233	100	QP
4	450.0100	38.28	-4.77	33.51	56.90	-23.39	29	100	QP
5	549.9950	42.72	-2.91	39.81	56.90	-17.09	186	200	QP
6	649.8300	39.93	-1.11	38.82	56.90	-18.08	8	100	QP

Remark: 1. QP = Quasi Peak
 2. Correction Factor = Antenna factor + Cable loss (Antenna to preamplifier) - preamplifier Gain + Cable loss (preamplifier to receiver)
 3. Measurement Value = Reading Level + Correct Factor
 4. Margin Level = Measurement Value - Limit Value



Test Voltage	55Vdc (from PoE)	Frequency Range	30 – 1000 MHz
Environmental Conditions	22°C, 41% RH	6dB Bandwidth	120 kHz
Test Date	2021/08/26	Test Distance	3m
Tested by	Karwin Kao	Polarization	Vertical
Test Site	W08	Test mode	B

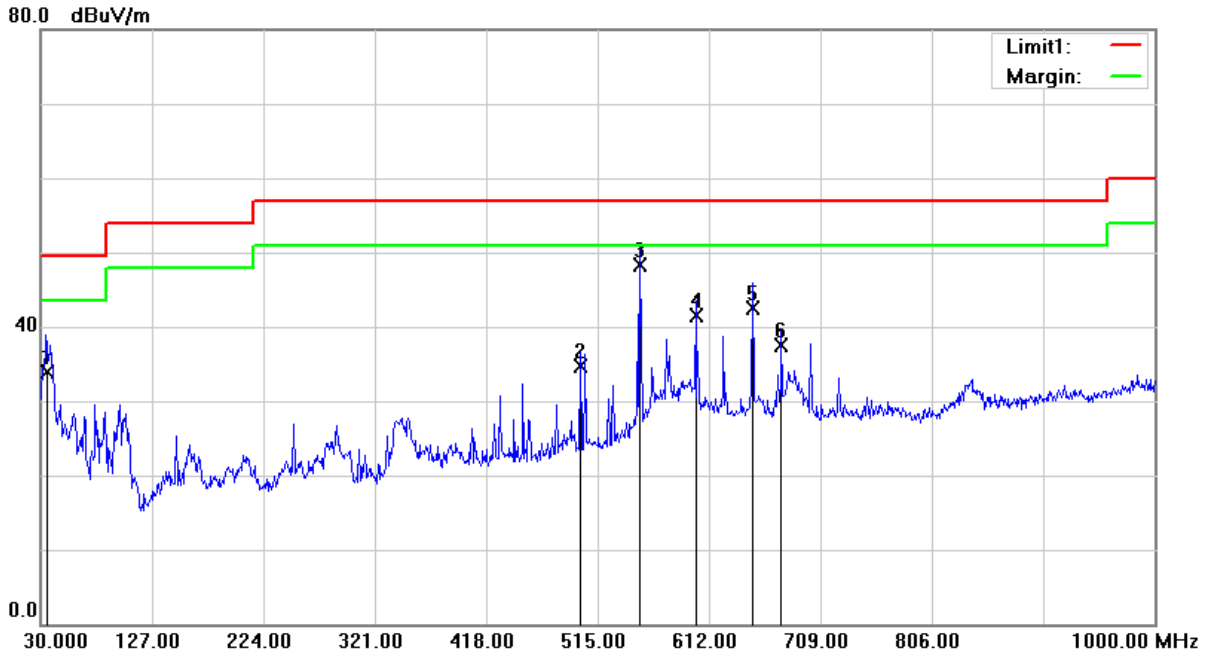

No.	Frequency (MHz)	Reading Level (dBμV)	Correct Factor (dB/m)	Measurement (dBμV/m)	Limit (dBμV/m)	Margin (dB)	Table Degree (degree)	Antenna Height (cm)	Detector
1	36.1450	43.99	-10.01	33.98	49.50	-15.52	186	200	QP
2	500.4500	38.75	-3.99	34.76	56.90	-22.14	47	100	QP
3	551.8600	51.16	-2.86	48.30	56.90	-8.60	294	100	QP
4	600.3600	43.17	-1.67	41.50	56.90	-15.40	162	100	QP
5	649.9950	43.62	-1.11	42.51	56.90	-14.39	360	100	QP
6	675.0500	38.14	-0.62	37.52	56.90	-19.38	351	100	QP

Remark: 1. QP = Quasi Peak
 2. Correction Factor = Antenna factor + Cable loss (Antenna to preamplifier) - preamplifier Gain + Cable loss (preamplifier to receiver)
 3. Measurement Value = Reading Level + Correct Factor
 4. Margin Level = Measurement Value - Limit Value



Test Voltage	55Vdc (from PoE)	Frequency Range	30 – 1000 MHz
Environmental Conditions	22°C, 41% RH	6dB Bandwidth	120 kHz
Test Date	2021/08/26	Test Distance	3m
Tested by	Karwin Kao	Polarization	Horizontal
Test Site	W08	Test mode	B

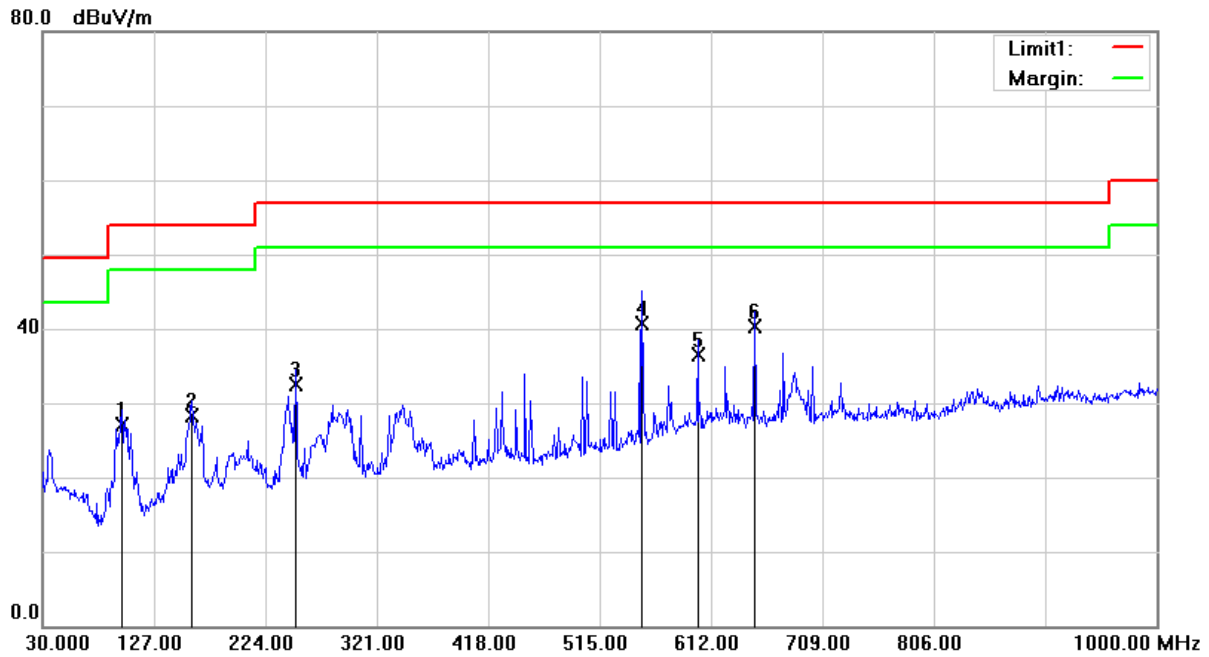

No.	Frequency (MHz)	Reading Level (dBμV)	Correct Factor (dB/m)	Measurement (dBμV/m)	Limit (dBμV/m)	Margin (dB)	Table Degree (degree)	Antenna Height (cm)	Detector
1	98.8700	41.76	-14.68	27.08	54.00	-26.92	266	200	QP
2	159.9800	37.16	-8.82	28.34	54.00	-25.66	276	200	QP
3	250.1900	40.56	-7.96	32.60	56.90	-24.30	306	100	QP
4	551.9950	43.51	-2.86	40.65	56.90	-16.25	317	200	QP
5	600.3600	38.23	-1.67	36.56	56.90	-20.34	252	100	QP
6	649.8300	41.47	-1.11	40.36	56.90	-16.54	300	200	QP

Remark: 1. QP = Quasi Peak
 2. Correction Factor = Antenna factor + Cable loss (Antenna to preamplifier) - preamplifier Gain + Cable loss (preamplifier to receiver)
 3. Measurement Value = Reading Level + Correct Factor
 4. Margin Level = Measurement Value - Limit Value



Test Voltage	120Vac, 60Hz	Frequency Range	1 – 10GHz
Environmental Conditions	21°C, 48% RH	6dB Bandwidth	1MHz
Test Date	2021/08/27	Test Distance	3m
Tested by	Karwin Kao	Polarization	Vertical
Test Site	W08	Test mode	A

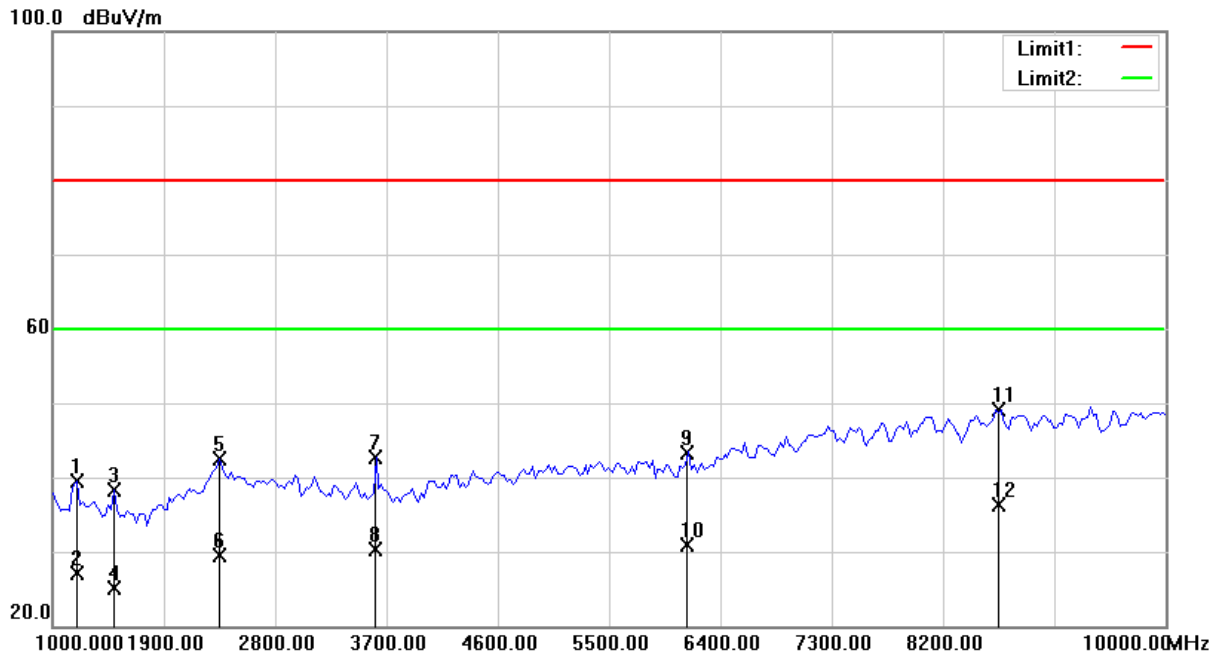

No.	Frequency (MHz)	Reading Level (dBμV)	Correct Factor (dB/m)	Measurement (dBμV/m)	Limit (dBμV/m)	Margin (dB)	Table Degree (degree)	Antenna Height (cm)	Detector
1	1202.500	57.68	-18.10	39.58	80.00	-40.42	194	100	peak
2	1202.500	45.30	-18.10	27.20	60.00	-32.80	194	100	AVG
3	1495.000	55.93	-17.59	38.34	80.00	-41.66	0	165	peak
4	1495.000	42.70	-17.59	25.11	60.00	-34.89	0	165	AVG
5	2350.000	54.76	-12.22	42.54	80.00	-37.46	45	200	peak
6	2350.000	41.81	-12.22	29.59	60.00	-30.41	45	200	AVG
7	3610.000	54.35	-11.67	42.68	80.00	-37.32	172	100	peak
8	3610.000	41.97	-11.67	30.30	60.00	-29.70	172	100	AVG
9	6130.000	49.27	-5.90	43.37	80.00	-36.63	40	100	peak
10	6130.000	36.78	-5.90	30.88	60.00	-29.12	40	100	AVG
11	8650.000	49.63	-0.60	49.03	80.00	-30.97	140	100	peak
12	8650.000	36.91	-0.60	36.31	60.00	-23.69	140	100	AVG

Remark: 1. peak = Peak, AVG = Average
 2. Correction Factor = Antenna factor + Cable loss (Antenna to preamplifier) - preamplifier Gain + Cable loss (preamplifier to receiver)
 3. Measurement Value = Reading Level + Correct Factor
 4. Margin Level = Measurement Value - Limit Value



Test Voltage	120Vac, 60Hz	Frequency Range	1 – 10GHz
Environmental Conditions	21°C, 48% RH	6dB Bandwidth	1MHz
Test Date	2021/08/27	Test Distance	3m
Tested by	Karwin Kao	Polarization	Horizontal
Test Site	W08	Test mode	A

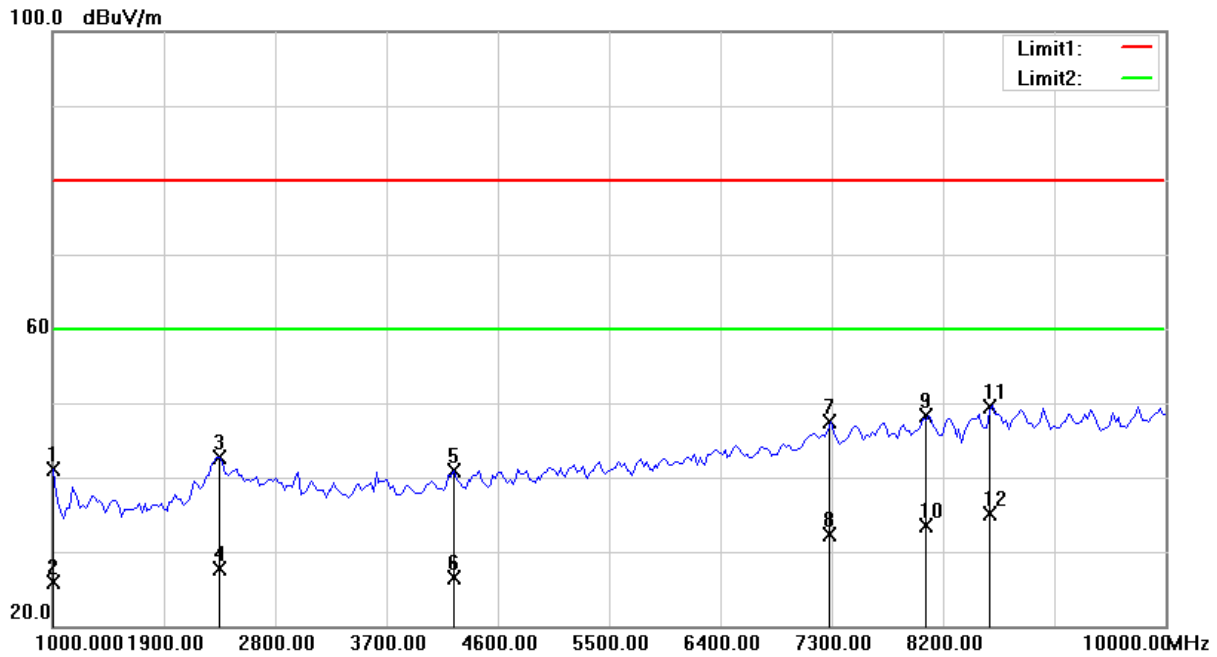

No.	Frequency (MHz)	Reading Level (dBμV)	Correct Factor (dB/m)	Measurement (dBμV/m)	Limit (dBμV/m)	Margin (dB)	Table Degree (degree)	Antenna Height (cm)	Detector
1	1000.0000	60.65	-19.62	41.03	80.00	-38.97	47	200	peak
2	1000.0000	45.59	-19.62	25.97	60.00	-34.03	47	200	AVG
3	2350.000	54.91	-12.22	42.69	80.00	-37.31	131	200	peak
4	2350.000	39.92	-12.22	27.70	60.00	-32.30	131	200	AVG
5	4240.000	51.23	-10.37	40.86	80.00	-39.14	342	200	peak
6	4240.000	36.83	-10.37	26.46	60.00	-33.54	342	200	AVG
7	7277.500	49.03	-1.56	47.47	80.00	-32.53	311	100	peak
8	7277.500	33.78	-1.56	32.22	60.00	-27.78	311	100	AVG
9	8065.000	49.03	-0.64	48.39	80.00	-31.61	147	200	peak
10	8065.000	34.07	-0.64	33.43	60.00	-26.57	147	200	AVG
11	8582.500	50.46	-0.86	49.60	80.00	-30.40	134	100	peak
12	8582.500	35.94	-0.86	35.08	60.00	-24.92	134	100	AVG

Remark: 1. peak = Peak, AVG = Average
 2. Correction Factor = Antenna factor + Cable loss (Antenna to preamplifier) - preamplifier Gain + Cable loss (preamplifier to receiver)
 3. Measurement Value = Reading Level + Correct Factor
 4. Margin Level = Measurement Value - Limit Value



Test Voltage	55Vdc (from PoE)	Frequency Range	1 – 10GHz
Environmental Conditions	21°C, 48% RH	6dB Bandwidth	1MHz
Test Date	2021/08/27	Test Distance	3m
Tested by	Karwin Kao	Polarization	Vertical
Test Site	W08	Test mode	B

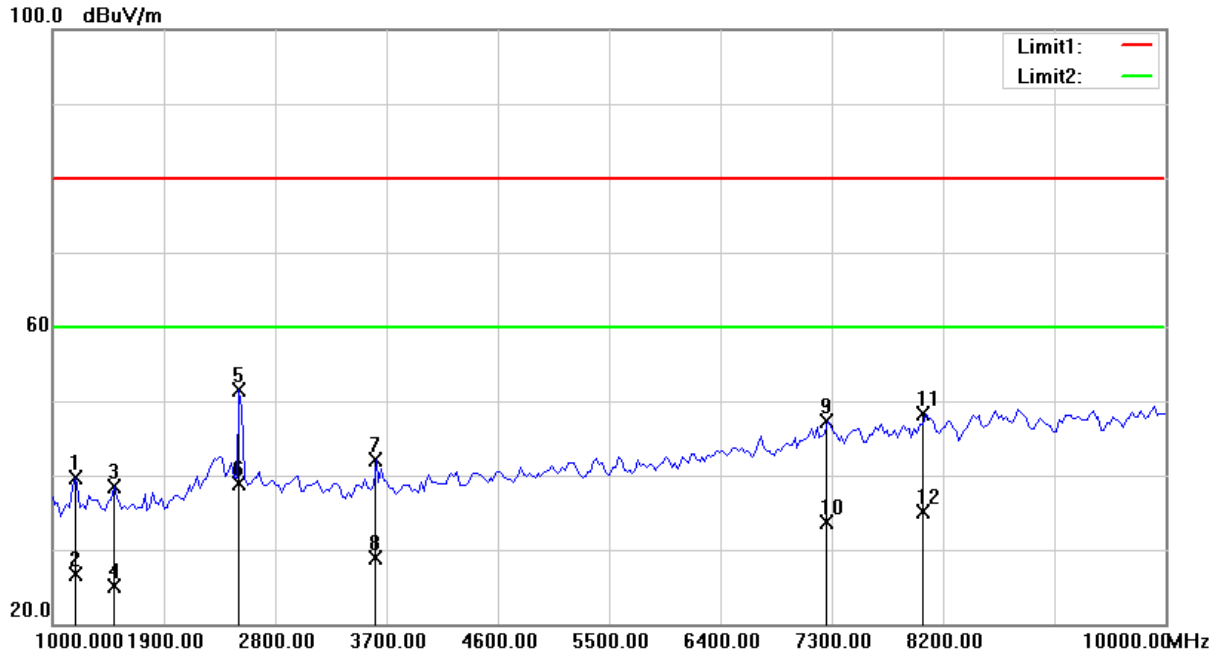

No.	Frequency (MHz)	Reading Level (dBμV)	Correct Factor (dB/m)	Measurement (dBμV/m)	Limit (dBμV/m)	Margin (dB)	Table Degree (degree)	Antenna Height (cm)	Detector
1	1180.000	57.96	-18.21	39.75	80.00	-40.25	273	200	peak
2	1180.000	44.94	-18.21	26.73	60.00	-33.27	273	200	AVG
3	1495.000	56.07	-17.59	38.48	80.00	-41.52	360	100	peak
4	1495.000	42.64	-17.59	25.05	60.00	-34.95	360	100	AVG
5	2507.500	64.73	-13.20	51.53	80.00	-28.47	17	100	peak
6	2507.500	52.11	-13.20	38.91	60.00	-21.09	17	100	AVG
7	3610.000	53.77	-11.67	42.10	80.00	-37.90	149	100	peak
8	3610.000	40.59	-11.67	28.92	60.00	-31.08	149	100	AVG
9	7255.000	48.82	-1.53	47.29	80.00	-32.71	162	100	peak
10	7255.000	35.29	-1.53	33.76	60.00	-26.24	162	100	AVG
11	8042.500	48.99	-0.63	48.36	80.00	-31.64	118	100	peak
12	8042.500	35.78	-0.63	35.15	60.00	-24.85	118	100	AVG

Remark: 1. peak = Peak, AVG = Average
 2. Correction Factor = Antenna factor + Cable loss (Antenna to preamplifier) - preamplifier Gain + Cable loss (preamplifier to receiver)
 3. Measurement Value = Reading Level + Correct Factor
 4. Margin Level = Measurement Value - Limit Value



Test Voltage	55Vdc (from PoE)	Frequency Range	1 – 10GHz
Environmental Conditions	21°C, 48% RH	6dB Bandwidth	1MHz
Test Date	2021/08/27	Test Distance	3m
Tested by	Karwin Kao	Polarization	Horizontal
Test Site	W08	Test mode	B

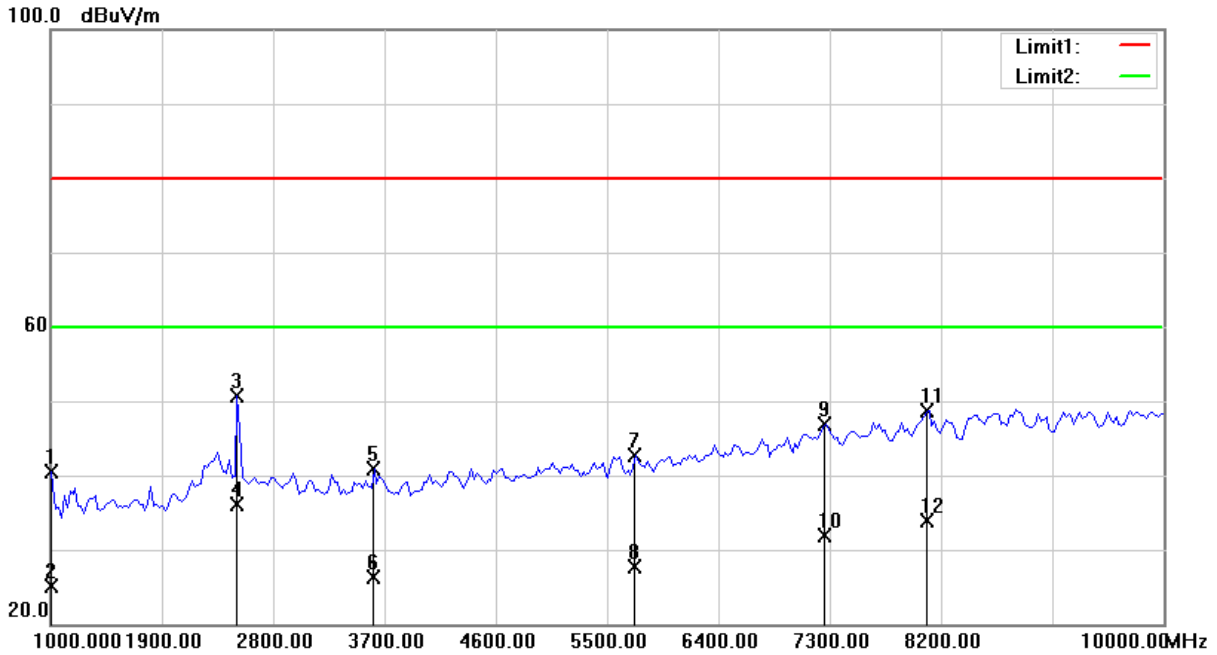

No.	Frequency (MHz)	Reading Level (dBμV)	Correct Factor (dB/m)	Measurement (dBμV/m)	Limit (dBμV/m)	Margin (dB)	Table Degree (degree)	Antenna Height (cm)	Detector
1	1000.0000	60.21	-19.62	40.59	80.00	-39.41	213	100	peak
2	1000.0000	44.64	-19.62	25.02	60.00	-34.98	213	100	AVG
3	2507.500	63.95	-13.20	50.75	80.00	-29.25	196	200	peak
4	2507.500	49.31	-13.20	36.11	60.00	-23.89	196	200	AVG
5	3610.000	52.49	-11.67	40.82	80.00	-39.18	157	100	peak
6	3610.000	37.97	-11.67	26.30	60.00	-33.70	157	100	AVG
7	5725.000	49.78	-7.10	42.68	80.00	-37.32	117	200	peak
8	5725.000	34.89	-7.10	27.79	60.00	-32.21	117	200	AVG
9	7255.000	48.39	-1.53	46.86	80.00	-33.14	111	200	peak
10	7255.000	33.37	-1.53	31.84	60.00	-28.16	111	200	AVG
11	8087.500	49.45	-0.65	48.80	80.00	-31.20	360	125	peak
12	8087.500	34.56	-0.65	33.91	60.00	-26.09	360	125	AVG

Remark: 1. peak = Peak, AVG = Average
 2. Correction Factor = Antenna factor + Cable loss (Antenna to preamplifier) - preamplifier Gain + Cable loss (preamplifier to receiver)
 3. Measurement Value = Reading Level + Correct Factor
 4. Margin Level = Measurement Value - Limit Value

4.2.7 Photographs of Test Configuration

Radiated Emission Test (30MHz~1GHz) Test mode A



Test mode B



Radiated Emission Test (Above 1GHz)
Test mode A

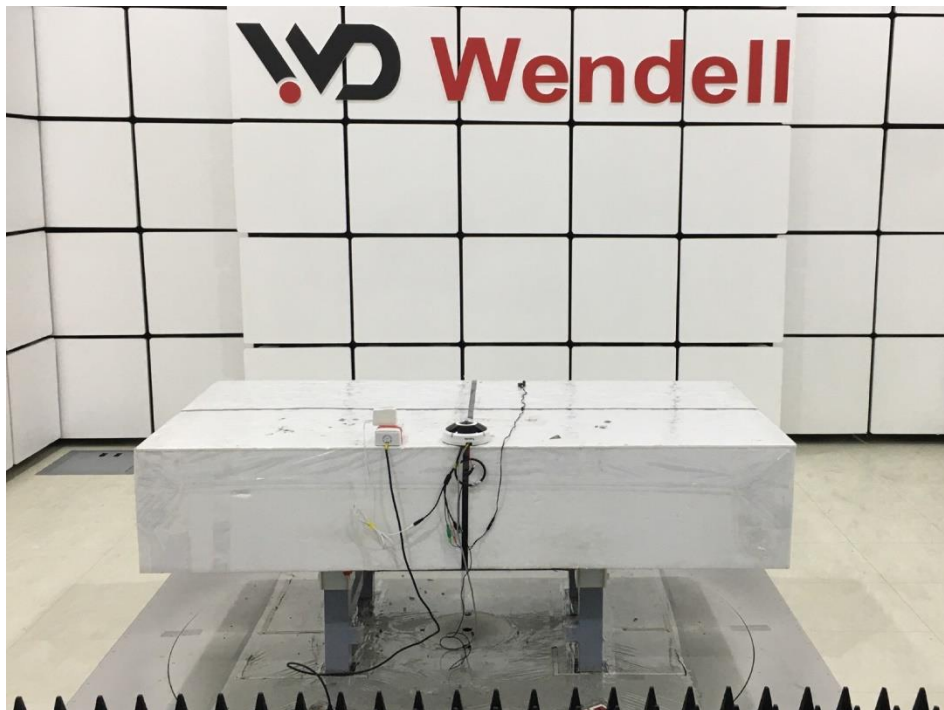

Test mode B

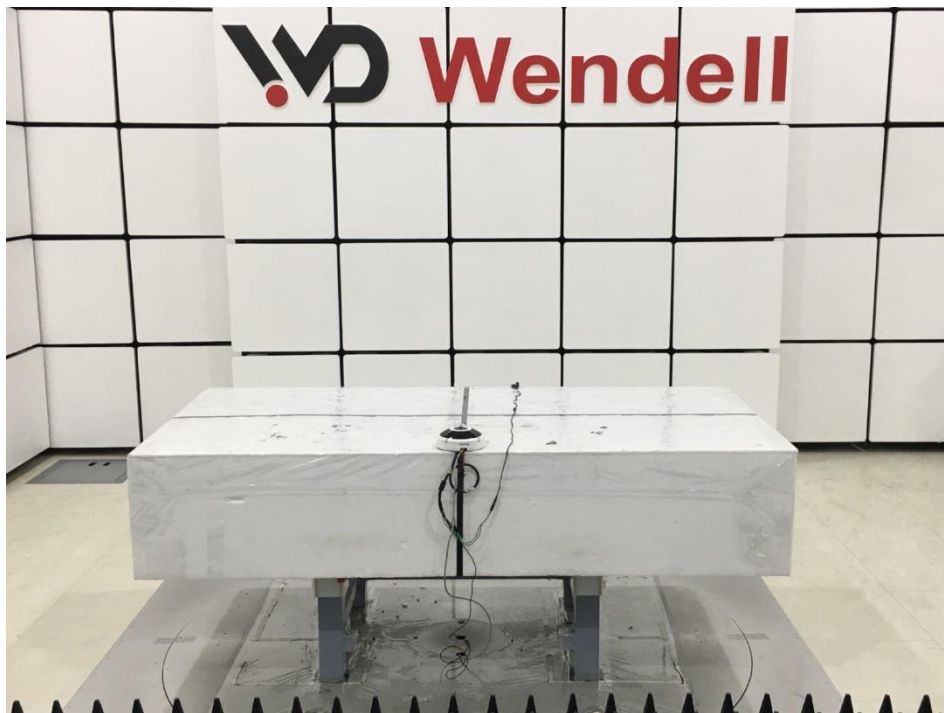
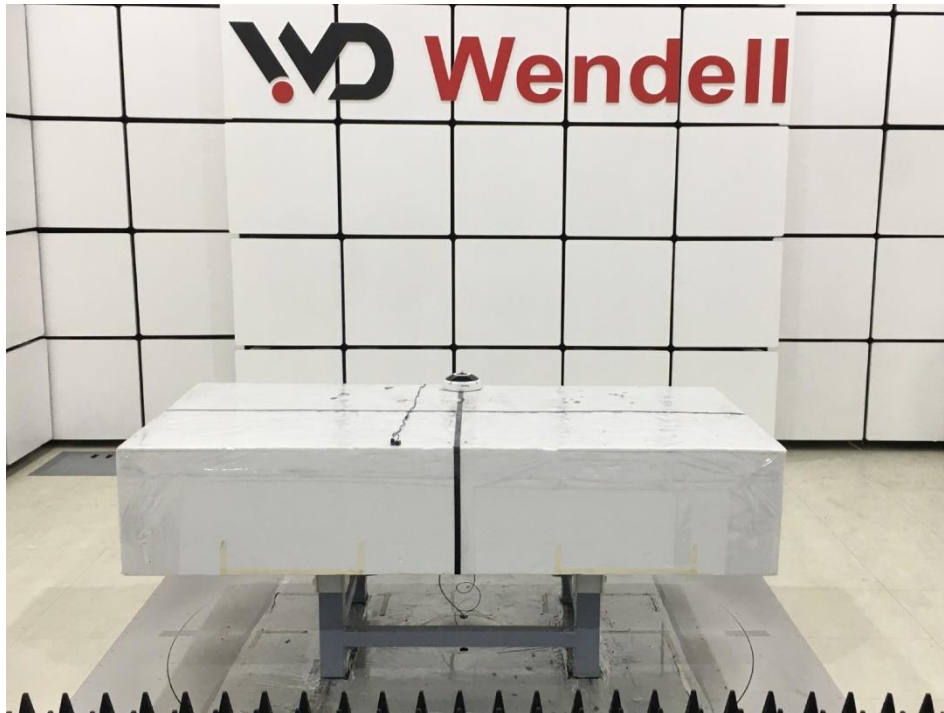

< End Page >