

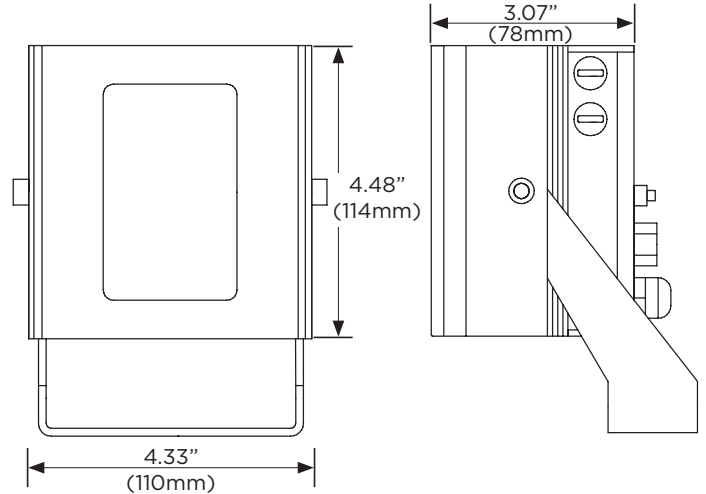

## Dimensions

unit: Inch (mm)



## Summary

These NightWatch™ DW-ILIRIP850 and DW-ILIRIP940 are NDAA/TAA compliant IP-enabled Infrared (IR) LED outdoor illuminators. The illuminators incorporate the latest surface mount Dual-Core™ LEDs, combined with enhanced optical output and outstanding reliability to provide users with smart lighting solutions for a wide range of applications.

The NightWatch™ illuminators include an interchangeable lens pack to deliver a variety of angles out of the box providing users the flexibility to create different elliptical beam profiles. Using PoE and IP communication, the SiteWatch™ detectors support direct integration with DW Spectrum® IPVMS.

## Features

- Infrared LED illuminators
- Interchangeable lens pack to deliver a variety of angles out of the box
- Create different elliptical beam profiles
- Coverage distance up to 614' (187m). (DW-ILIRIP850)
- Coverage distance up to 374' (115m). (DW-ILIRIP940)
- Configure lights to switch on when motion is detected (detector required)
- Adjustable photocell and illumination levels
- 940nm wavelength (DW-ILIRIP940)
- 850nm wavelength (DW-ILIRIP850)
- Web interface built-in
- High-power Dual-Core™ LEDs with advanced, current limited, integral control circuitry
- NDAA/TAA compliant
- IP66 environmental-rated dust-tight and water-resistant
- IK 09-rated impact-resistant

## Specifications

Model	DW-ILIRIP850	DW-ILIRIP940
Construction	Robust high-quality aluminum extrusion	
Photocell	Adjustable 20 - 70 lux	
Illumination	Adjustable 10% - 100%	
Operating temperature	-58°F to 122°F (-50°C to 50°C)	
Mount	Powder coated stainless steel wall mount	
Input	PoE+ (IEEE802.3at)	
Consumption	26W	
IP rating	IP66 environmental-rated dust-tight and water-resistant in accordance with EN60529:1992	
Electronics	High efficiency surface mount high power Dual-Core™ LEDs with advanced, current limited, integral control circuitry.	
Recommended PSU	Any IEEE 802.3at injector (not included)	
Remote access	Web browser user interface. No software or installation needed.	
Wavelength	850nm	940nm
Coverage distance	614ft (187m)	374ft (115m)
Warranty	2 year warranty	

## Accessories (optional)



DW-ILWM1  
Mounting bracket for a single (1) illuminator



DW-ILWM3  
Mounting bracket for three (3) illuminators



DW-ILWM2  
Mounting bracket for two (2) illuminators



DW-ILPM1  
Pole mount bracket for a single (1) illuminator

(See second page for coverage details)

Product Code	Wavelength	Angle	Distance		FOV	
DW-ILIRIP850	850nm	10° - Circular	187m	614'	33m	107'
		20° - Elliptical	128m	418'	45m	148'
		30° - Elliptical	94m	307'	50m	164'
		60° - Elliptical	60m	195'	69m	225'
		80° - Elliptical	43m	139'	71m	234'
		95° - Elliptical	30m	98'	65m	213'

Product Code	Wavelength	Angle	Distance		FOV	
DW-ILIRIP940	940nm	10° - Circular	115m	376'	20m	66'
		20° - Elliptical	80m	262'	28m	93'
		30° - Elliptical	65m	213'	35m	114'
		60° - Elliptical	40m	131'	46m	152'
		80° - Elliptical	30m	98'	50m	165'
		95° - Elliptical	20m	66'	44m	143'