

SiteWatch™ Horn IP Speaker

DW-SWSP30AM



User's Manual Ver. 04/25

Before installing and using the camera, please read this manual carefully.
Be sure to keep it handy for future reference.

Table of Content

1.	Overview	3
2.	What's in the box	3
3.	Hardware Installation	4
4.	Adding the Speaker to DW Spectrum	5
5.	Web Configuration.....	5
5.1	Status	6
5.2	Basic	7
5.2.1	Network	7
5.2.2	Date/Time	8
5.3	SIP Account.....	9
5.4	Audio.....	11
5.5	Media File.....	12
5.6	Alarm.....	13
5.7	HTTP Commands	14
5.8	Schedule	15
5.9	RTP Multicast.....	16
5.10	Firewall	17
5.11	System.....	18
5.11.1	Upgrade.....	18
5.11.2	Security.....	18
5.12	Administrator Password Reset.....	19
6.	IP Finder.....	20
7.	Product Specifications.....	21
8.	Product Dimensions	21
9.	Warranty Information.....	23
10.	Limits and Exclusions	24





1. Overview

This standalone, 30-Watt, IP-enabled smart audio IP horn speaker helps to proactively deter crime by responding to real-time events with automated and manual voice alerts. The IP66-rated housing has a built-in microphone for two-way communication, alarm input and is ideal for challenging outdoor environmental conditions with high ambient noise. The speaker supports digital signal processing (DSP) for clearer sound, has a built-in memory to support pre-recorded messages, and can play music, loud ringing, voice paging, and notifications with live speech. The speaker is fully integrated with DW Spectrum IPVMS and supported IP cameras and can integrate easily with 3rd party access control, analytics, and VoIP (supporting SIP) via open standards. The DW smart audio speaker is an ideal, scalable, and flexible approach to system design and comes with DW's 2-year warranty.

2. What's in the box

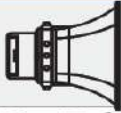
Check that all items listed below are included with your speaker. Contact your sales representative if any items are missing.

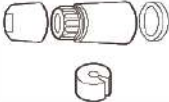
WHAT'S IN THE BOX					
IP Horn Speaker		1	Quick Setup Guide		1
Waterproof Cap		1			

NOTE: Mounting fasteners are not included. Use M8 fasteners or screws with an outer diameter of 5/16" or smaller.

3. Hardware Installation

1. Mark and drill the holes in the mounting surface using the speaker's mounting bracket.
2. Pass wires through and make all the necessary connections. Connect to the camera's network. Use the waterproof cap for an added layer of protection from moisture. See the diagram on the right for installation.

NOTE: The speaker can be powered by PoE or 12V/24V DC. Both power sources CANNOT be used at the same time.

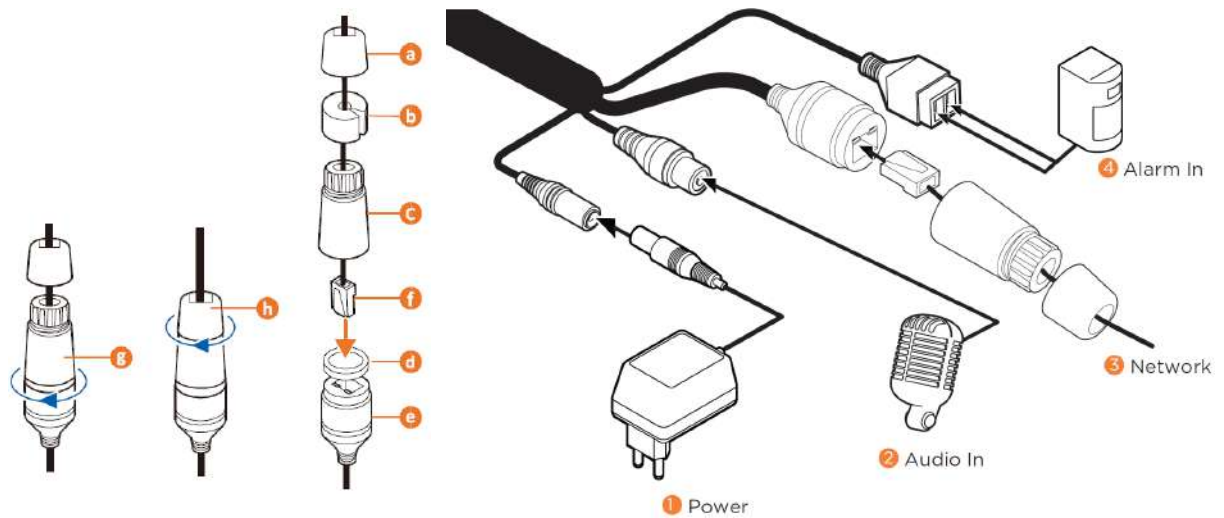

3. Secure the speaker to the mounting surface.

NOTE: Mounting fasteners are not included. Use M8 fasteners or screws with an outer diameter of 5/16" or smaller.

4. Complete the speaker's setup using the speaker's web interface. Open a web browser and enter the speaker's IP address.
 - Default IP address: 192.168.1.50.
 - Default username: admin
 - Default password: admin
(The password must be changed during the initial installation)
5. Change the IP address of the speaker to the same subnet range as the cameras.

4. Adding the Speaker to DW Spectrum

1. Open the DW Spectrum client.
2. DW-SWSP30AM should be listed under the resource tree if auto-discovery is enabled and the DW Spectrum media server and the speaker are on the same network.
*If auto-discovery is disabled, add the speaker manually. Refer to the DW Spectrum user manual for more information.

5. Web Configuration

The speaker settings can be configured through a web interface. While connected to the same network, users can access the web interface through a browser using the default URL <http://192.168.1.50> unless this has been changed.

- Default Username: admin
- Default Password: admin

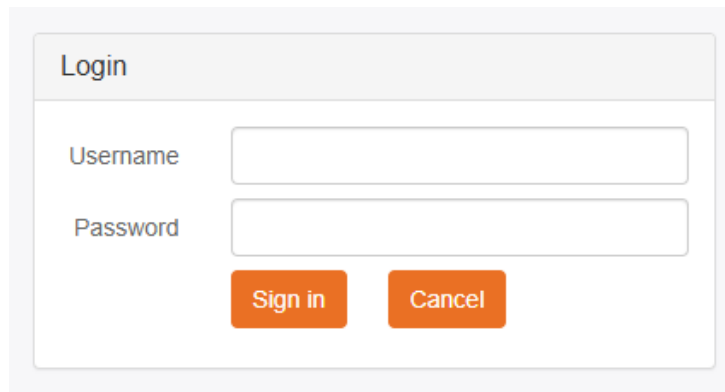

The screenshot shows a web interface titled "Login". It contains two input fields: "Username" and "Password". Below the input fields are two buttons: "Sign in" and "Cancel".

After logging in to the speaker, users will be prompted to update the password. The password must meet the following minimum requirements: at least 8 characters, a combination of uppercase and lowercase letters, and special characters.

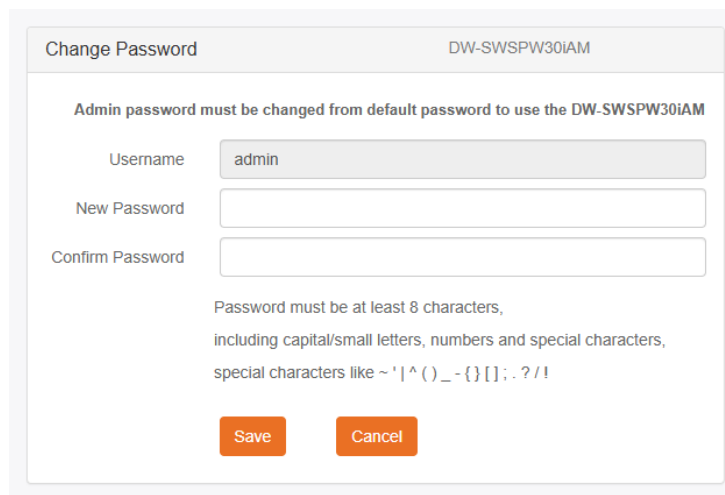

The screenshot shows a web interface titled "Change Password" for the device "DW-SWSPW30iAM". It contains a message: "Admin password must be changed from default password to use the DW-SWSPW30iAM". Below the message are three input fields: "Username" (pre-filled with "admin"), "New Password", and "Confirm Password". Below the input fields is a password requirement message: "Password must be at least 8 characters, including capital/small letters, numbers and special characters, special characters like ~ '^ () _ - {} [] ; . ? / !". At the bottom are two buttons: "Save" and "Cancel".

5.1 Status

In the *Status* menu, the firmware version, free space, and status for the two SIP accounts will be displayed. In the *Network* menu, users can find the MAC address and IP address current configuration.

The screenshot displays the DW web interface. On the left is a navigation menu with the following items: Status (highlighted), Basic, SIP Account, Audio, Media File, Alarm, HTTP Commands, Schedule, RTP Multicast, Firewall, and System. The main content area is split into two sections. The top section, titled 'Status', shows the following information: Device Time (03/17/2025 08:49:16 AM), Serial Number (SWSPW30IAM2411190153), Model Name (DW-SWSPW30IAM), Firmware Ver (SWSPW30IAM_V4.1.0-IN4), Free Space (3792KB), SIP1 Status (NONE), and SIP2 Status (NONE). The bottom section, titled 'Network', shows: MAC Address (A8:DC:5A:30:04:A7), IP Address (192.168.1.50), Subnet Mask (255.255.255.0), Gateway (192.168.1.1), Primary DNS (192.168.1.1), and Secondary DNS (8.8.8.8). A 'Refresh' button is located at the bottom right of the Network section.

Status	
Device Time	03/17/2025 08:49:16 AM
Serial Number	SWSPW30IAM2411190153
Model Name	DW-SWSPW30IAM
Firmware Ver	SWSPW30IAM_V4.1.0-IN4
Free Space	3792KB
SIP1 Status	NONE
SIP2 Status	NONE

Network	
MAC Address	A8:DC:5A:30:04:A7
IP Address	192.168.1.50
Subnet Mask	255.255.255.0
Gateway	192.168.1.1
Primary DNS	192.168.1.1
Secondary DNS	8.8.8.8

5.2 Basic

5.2.1 Network

In the *Network* menu, select the preferred network configuration settings for the IP speaker. Whenever the IP address is updated, users must enter the new IP address when accessing through a browser.

The screenshot shows the 'Network' configuration interface. At the top, there is an orange header with the word 'Network'. Below it, there are two radio button options: 'DHCP' (which is unselected) and 'Static IP Address' (which is selected). Under the 'Static IP Address' option, there are five input fields: 'IP Address' containing '192.168.1.50', 'Subnet Mask' containing '255.255.255.0', 'Gateway' containing '192.168.1.1', 'Primary DNS' containing '192.168.1.1', and 'Secondary DNS' containing '8.8.8.8'. At the bottom right of the form is an orange 'Save' button.

- DHCP: When selected, the server automatically updates the speaker's IP address as assigned by the connected DHCP network device (router, smart switch, etc.).
- Static IP address: When selected, users must manually enter the speaker's network settings information. Enter the speaker's IP address, subnet mask, gateway, and primary and secondary DNS addresses. The IP address will not change unless manually adjusted.

In the *Network Advanced* menu, adjust the network communication port(s) and select the transfer protocol as needed.

The screenshot shows the 'Network Advanced' configuration interface. At the top, there is an orange header with the text 'Network Advanced'. Below it, there are three configuration items: 'Http/Https' with a dropdown menu set to 'Http&Https' and a note '*Take effect after restart!'; 'Http Port' with an input field containing '80' and a range '(80, 1025~65534)'; and 'Https Port' with an input field containing '443' and a range '(443, 1025~65534)'. At the bottom right of the form is an orange 'Save' button.

- HTTP/HTTPS: Select the preferred transfer protocol to communicate directly with the speaker using a web browser.
- HTTP Port: Select the port value for the Hypertext Transfer Protocol communication (default: 80).

- HTTPS Port: Select the communication port value for the Hypertext Transfer Protocol Secure communication (default: 443).

* The self-signed certificate is embedded in the unit and cannot be updated.

Press the '**Save**' button to save all changes.

5.2.2 Date/Time

There are two Update Mode options for Date/Time settings:

- NTP: Automatically uses time settings provided by an external server via the Network Time Protocol
 - * To sync with any Internet time servers, the device must have access to the Internet.
- Current Computer: The speaker will sync with the date and time of the computer used to access the speaker settings.

Choose the preferred Update Mode and set the local time zone. If NTP is selected, configure the following settings:

- Time Zone: Set the local time UTC zone for the speaker.
- Daylight Savings: Enable the toggle to adjust for daylight saving time.
- NTP Server: Set the preferred network time protocol server (default: time.google.com).
- Sync Interval: Set the time interval in minutes to sync with the NTP server (default is 1440 minutes, 24 hours).

Press the '**Save**' button to save all changes.

Date/Time

Device Time 03/17/2025 08:26:43 AM

Sync With NTP

TimeZone UTC-08:00 United St:

Daylight Savings

NTP Server time.google.com

Sync Interval 1440 Minutes

Save

Date/Time

Device Time 03/17/2025 08:26:43 AM

Sync With Current Computer ▼

Computer Time 03/17/2025 08:26:43 AM

Save

5.3 SIP Account

The speaker has two SIP (Session Initiation Protocol) accounts that can be set up separately for initiating, maintaining and terminating communication sessions.

To configure, select the SIP 'Account' from the drop-down at the top of the *SIP Account* menu and configure the settings below.

Press the '**Save**' button to save all changes.

SIP Set

Account Account 1 ▼ NONE

User Name

Auth ID

Password

Display Name

Server Host

Server Port

Outbound Proxy Disable ▼

Expire Time Seconds

Ringing Tone bell1 ▼ ⓘ

Auto Answer Answer Immediately ▼

Incoming Notify

Answer Notify

Save

SIP Advanced

SIP Protocol UDP ▼

Encryption None ▼

Save

- Account - Select an account to configure.
- User Name - Enter the username of the SIP account.

- Auth ID - Enter the authentication ID to register.
- Password - Enter the password associated with the SIP username entered above.
- Display Name - Enter the display name of the SIP account.
- Server Host - Enter the SIP server's IP address.
- Server Port - Enter the SIP server's port number.
- Outbound Proxy - Enable or disable the outbound proxy. When enabled, enter the proxy server's IP address and port number.
- Expire Time - Set the expiration time of registered account information.
- Ringing Tone - Set incoming ringtone from the available options.
- Auto Answer - Set the answer mode. Select from 'Answer Immediately' or 'Answer with Delay.' When 'Answer with Delay' is selected, enter the delay time in seconds.
- Incoming Notify - Enable sending HTTP commands/requests when an incoming call occurs.
- Answer Notify - Enable to send HTTP command/request when the call is answered.

Under the *SIP Advanced* menu, select the desired SIP Protocol.

Options are UDP, TCP and TLS.



The screenshot shows a web interface for SIP configuration. At the top, there is an orange header bar with the text "SIP Advanced". Below this, there is a form with a label "SIP Protocol" and a dropdown menu currently displaying "UDP". To the right of the dropdown menu is an orange "Save" button.

5.4 Audio

Users can adjust the speaker audio volume and preferred audio settings as needed.

In the *Codec* menu, users can enable the preferred audio codecs that can be used with the speaker by checking the appropriate boxes.



The *Speaker* menu has various settings.



- Volume: Adjust the output volume of the speaker between 0-100.
- Amp Auto OFF: Enabled by default. When enabled, the amplifier will automatically deactivate when the speaker is not broadcasting.
- Jitter buffer: Adjust the wait time (ms) between collecting and sending VoIP to stabilize the audio and reduce audio delays and sound distortion while outputting sound.
- HPF: Enable this feature to use a high-pass filter, primarily allowing higher audio frequencies.
- NR: Enable this feature to use noise reduction and automatically remove unwanted ambient noise from the audio output.

Press the '**Save**' button to save all changes.

5.5 Media File

There are five (5) default system audio files. These files cannot be altered.



#	Name	Play through PC audio output	Play through speaker
1	bell1	▶	🔊
2	bell2	▶	🔊
3	bell3	▶	🔊
4	bell4	▶	🔊
5	bell5	▶	🔊

Users can upload up to ten (10) custom media files (MP3 or WAV). Not to exceed the available storage, such as music, announcements, bells, etc., for additional audio-out options.

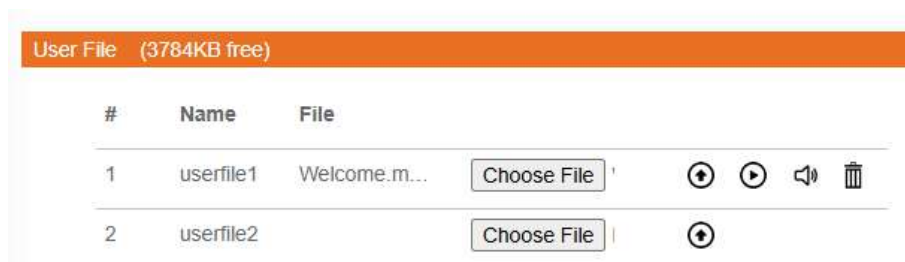

#	Name	File	Choose File	▶	🔊	🗑️
1	userfile1	Welcome.m...	Choose File	▶	🔊	🗑️
2	userfile2		Choose File	▶		

5.6 Alarm

The Alarm In function provides a means to integrate external systems with the speaker for enhanced security and alert functionality.

Users can select which sound to play in the "Play File" drop-down menu.

Users can also choose to cycle the sound with the following modes: Once only, multiple times, or for a duration.

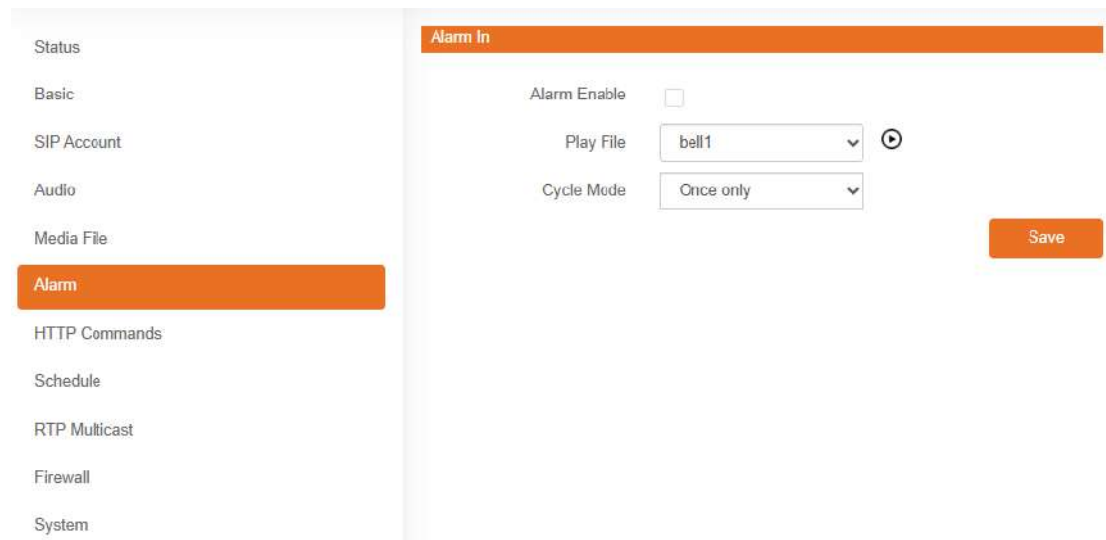

The screenshot shows a web interface for configuring the Alarm In function. On the left is a navigation menu with the following items: Status, Basic, SIP Account, Audio, Media File, Alarm (highlighted in orange), HTTP Commands, Schedule, RTP Multicast, Firewall, and System. The main content area is titled "Alarm In" and contains the following settings:

- Alarm Enable:
- Play File: A dropdown menu showing "bell1" with a play button icon to its right.
- Cycle Mode: A dropdown menu showing "Once only".
- Save: An orange button located at the bottom right of the configuration area.

5.7 HTTP Commands

Users can control the sound using an HTTP command from a web browser, VMS, cameras or network device to send commands to the speaker.

To use an HTTP command:

1. Open a browser or VMS on your computer.
2. Enter the HTTP URL and include the preferred media file for the alarm command as outlined in the HTTP Command examples provided below.

HTTP Commands

► Play sound.

`http://<ip_address>/api/play?action=start&file=<media_file>`

Example1: `http://192.168.1.50/api/play?action=start&file=bell1`

<media_file>

- bell1 ~ bell5
- userfile1 ~ userfile10

► Play sound with once cycle mode and set volume.

`http://<ip_address>/api/play?action=start&file=<media_file>&mode=once&volume=<vol_level>`

Example2: `http://192.168.1.50/api/play?action=start&file=userfile1&mode=once&volume=10`

<media_file>

- bell1 ~ bell5
- userfile1 ~ userfile10

<vol_level>

- 0 ~ 100

► Play sound with multiple cycle mode and set volume.

`http://<ip_address>/api/play?action=start&file=<media_file>&mode=multiple&count=<count_level>&volume=<vol_level>`

Example3: `http://192.168.1.50/api/play?action=start&file=userfile1&mode=multiple&count=10&volume=20`

<media_file>

- bell1 ~ bell5
- userfile1 ~ userfile10

<count_level>

- 0 ~ 120960

<vol_level>

- 0 ~ 100

► Play sound with multiple cycle mode and set duration, volume.

`http://<ip_address>/api/play?action=start&file=<media_file>&mode=duration&count=10&volume=30`

Example4: `http://192.168.1.50/api/play?action=start&file=userfile1&mode=duration&count=10&volume=30`

<media_file>

- bell1 ~ bell5
- userfile1 ~ userfile10

<count_level>

- 0 ~ 604800

<vol_level>

- 0 ~ 100































► Stop playing sound.

`http://<ip_address>/api/play?action=stop`

Example5: `http://192.168.1.50/api/play?action=stop`

5.8 Schedule

Users can schedule regular bell rings, announcements, and alarms in public areas such as schools, factories, and office spaces.

Schedule	
#	En... Name Time D... Action File
1	 
2	 
3	 
4	 
5	 
6	 
7	 
8	 
9	 
10	 
11	 
12	 
13	 
14	 
15	 

To add a schedule:

1. Click on the Edit icon to edit or add a new audio schedule.
2. Check the *Schedule Enable* box to enable the schedule. Uncheck the box to disable the schedule.
3. Create a name for the schedule. This name will appear in the *Schedule* list.
4. Select the days of the week and time for the scheduled audio. When setting the *Action Time*, either click the hour/minute and manually enter the value or click the Clock icon to select from a drop-down.
5. Configure the following:
 - Action type: select the preferred action type for this schedule (Start/Stop).
 - Play File: select the audio file that will trigger when this schedule activates.
 - Cycle mode:
 - Once only: play sound once
 - Multiple times: play sound multiple times continuously
 - Duration: play sound for a duration of time.

Press the **'Save'** button to save all changes.

5.9 RTP Multicast

Each device can receive up to ten (10) RTP IP addresses.

Do not use continuous port numbers, which can cause issues and conflicts.

For example:

239.255.1.2:8000, 239.255.0.1:8001, 239.255.0.1:8002 (**Don't Use**)

239.255.0.1:8000, 239.255.0.1:8002, 239.255.0.1:8004 (**OK**)

- Multicast address range: 224.0.0.0-239.255.255.
- Ports range: 1024-65536

Status	RTP Multicast	
Basic	Priority	IP Address (e.g. 239.255.0.1:5004)
SIP Account	1	<input type="text"/>
Audio	2	<input type="text"/>
Media File	3	<input type="text"/>
Alarm	4	<input type="text"/>
HTTP Commands	5	<input type="text"/>
Schedule	6	<input type="text"/>
RTP Multicast	7	<input type="text"/>
Firewall	8	<input type="text"/>
System	9	<input type="text"/>
	10	<input type="text"/>
		<input type="button" value="Save"/>

5.10 Firewall

Users can enable settings in the *Firewall* menu to adjust the speaker's security settings. Create a Firewall Rule to permit or deny access to devices as needed.

The screenshot displays the Firewall configuration page. On the left is a navigation menu with options: Status, Basic, SIP Account, Audio, Media File, Alarm, HTTP Commands, Schedule, RTP Multicast, **Firewall**, and System. The main content area is divided into two sections:

Firewall Rules

#	Name	Type	IP/MAC	Action	
1					
2					
3					
4					
5					

Automatic Defense Rules

#	Name	Protocol	Port Range	Rate	
1			-		
2			-		
3			-		
4			-		
5			-		

5.11 System

5.11.1 Upgrade

In the Upgrade selection of the *System* Menu

- Reboot: Click to power cycle the speaker device. Users must log back into the system once the reboot has been completed.
- Reset: Click to complete a system default and return the speaker to factory settings.
- Users must log back into the device's default IP address, username and password.
- FW Upgrade: Click to upgrade the firmware of the IP speaker device. See directions below.

5.11.2 Security

Users can set a new username and password in the *Security* section of the *System* menu. To change the login:

1. Enter the IP speaker's current username and password.
 - Default username: admin
 - Password: password set during initial setup
2. Assign the New Username and/or New Password to the IP speaker as desired. It is recommended that the username be kept as 'admin.'
3. Save the configuration and restart the IP speaker device to apply the changes.

The screenshot shows a web interface with a sidebar on the left containing menu items: Status, Basic, SIP Account, Audio, Media File, Alarm, HTTP Commands, Schedule, RTP Multicast, Firewall, and System (highlighted in orange). The main content area is divided into two sections:

System (orange header):

- Reboot: Reboot Device Now
- Reset: Reset to Factory Setting
- FW Upgrade: Choose File (No file chosen)

Security (orange header):

- New Password: [Text Input Field]
- Confirm Password: [Text Input Field]
- Save: [Orange Button]

5.12 Administrator Password Reset

The administrator password can be reset using the device's MAC address or serial number.

To reset the password, access the following URL using the speaker's IP address `http://{Speaker's IP Address}/pwreset.html`

Ex: `http://192.168.1.50/pwreset.html`

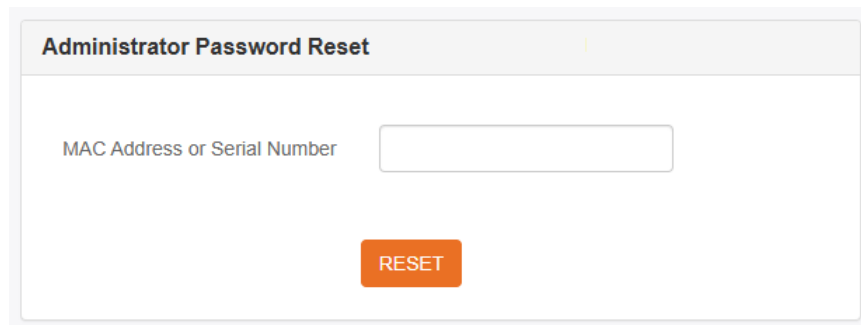

The image shows a web form titled "Administrator Password Reset". It features a text input field labeled "MAC Address or Serial Number" and an orange "RESET" button below it.

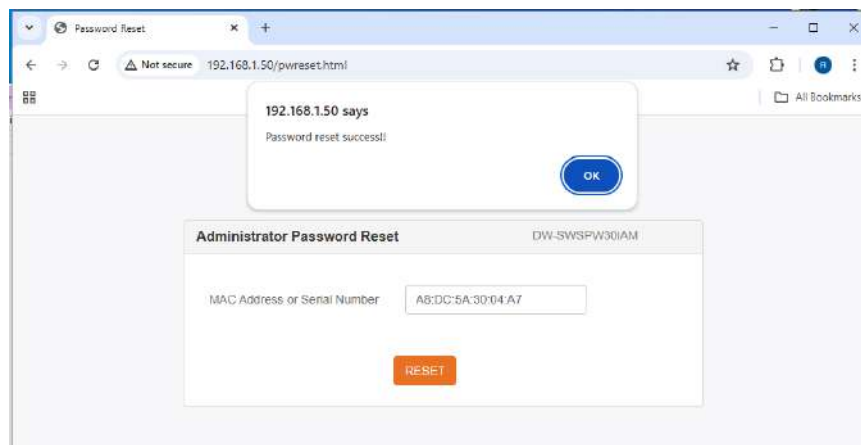

6. IP Finder

If users have difficulty accessing the speaker's web interface, users can use DW's IP finder. DW IP Finder is a software tool developed by Digital Watchdog that helps users locate and manage Digital Watchdog IP devices on a network. It can automatically scan the network for DW Sitewatch IP speakers. Visit <https://digital-watchdog.com/productdetail/DW-IP-Finder/>

for more information and to download the software.

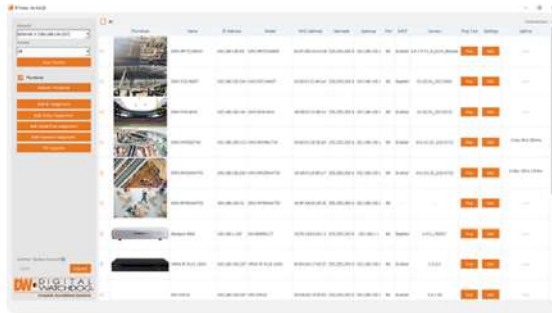

[Home](#) > [Products](#) > [DW IP Finder™](#)

DW IP Finder™

DW IP Finder

[Find a Reseller](#)

[Request a Demo](#)

[Contact Us](#)

[FAQs](#)



Features

- Support all DW's MEGApix® IP cameras
- Detect any OnVIF® device on the network
- Windows and Linux Ubuntu OS compatibility
- Remote firmware upgrade for multiple cameras simultaneously
- Thumbnail preview
- Filter search results by camera series
- Select from multiple networks
- Bulk password assignment
- Bulk IP address assignment
- Access the camera's network settings
- Uptime monitors how long a camera has been live since its last power cycle
- Free and easy to download. Included with all MEGApix® IP cameras

7. Product Specifications

Audio	
Codec	OPUS 48 kHz, MP3 44.1 kHz, G.722 ADPCM 16 kHz, G.711 PCMU 8 kHz, G.711 PCMA 8 kHz
MIC	
Built-in microphone	Yes
Speaker	
Max SPL	120dB
Frequency response	350Hz - 8KHz
Frequency range	500-2KHZ +-10dB 400-12KHZ +-20dB
Harmonic distortion	0.1@1kHz
Signal to noise ratio	91dB
Amplifier	Built-in 30W amplifier
Network	
Security	Password protection, IP address filtering, digest authentication, user access log
Network protocol	SIP, ONVIF, HTTP/HTTPS, IPv4, DHCP, RTSP, RTP, RTCP, TCP, UDP, ARP, FTP, TFTP, NFS, NTP
Network interface	10/100 Base-TX, RJ45
VoIP	Support SIP protocol for integration with VoIP systems, integrated with SIP/PBX
	Support SIP features: secondary/backend SIP server, IPv4
	Supported codecs: OPUS, G711U, G711A, GSM, MP3, WAV
General	
Operating temperature	-22°F - 140°F (-30°C ~ 60°C)
Operating humidity	5%-85%
Material	ABS (IP66-rated)
Power supply	PoE or DC 12V/24V
Interface	GPIO alarm in, audio in
Installation	Wall mounted
Dimensions	11.22" x 8.07" x 11.22" (285 x 205 x 285mm)
Weight	4.4 lbs (2 kg)
Warranty	2 years

8. Product Dimensions

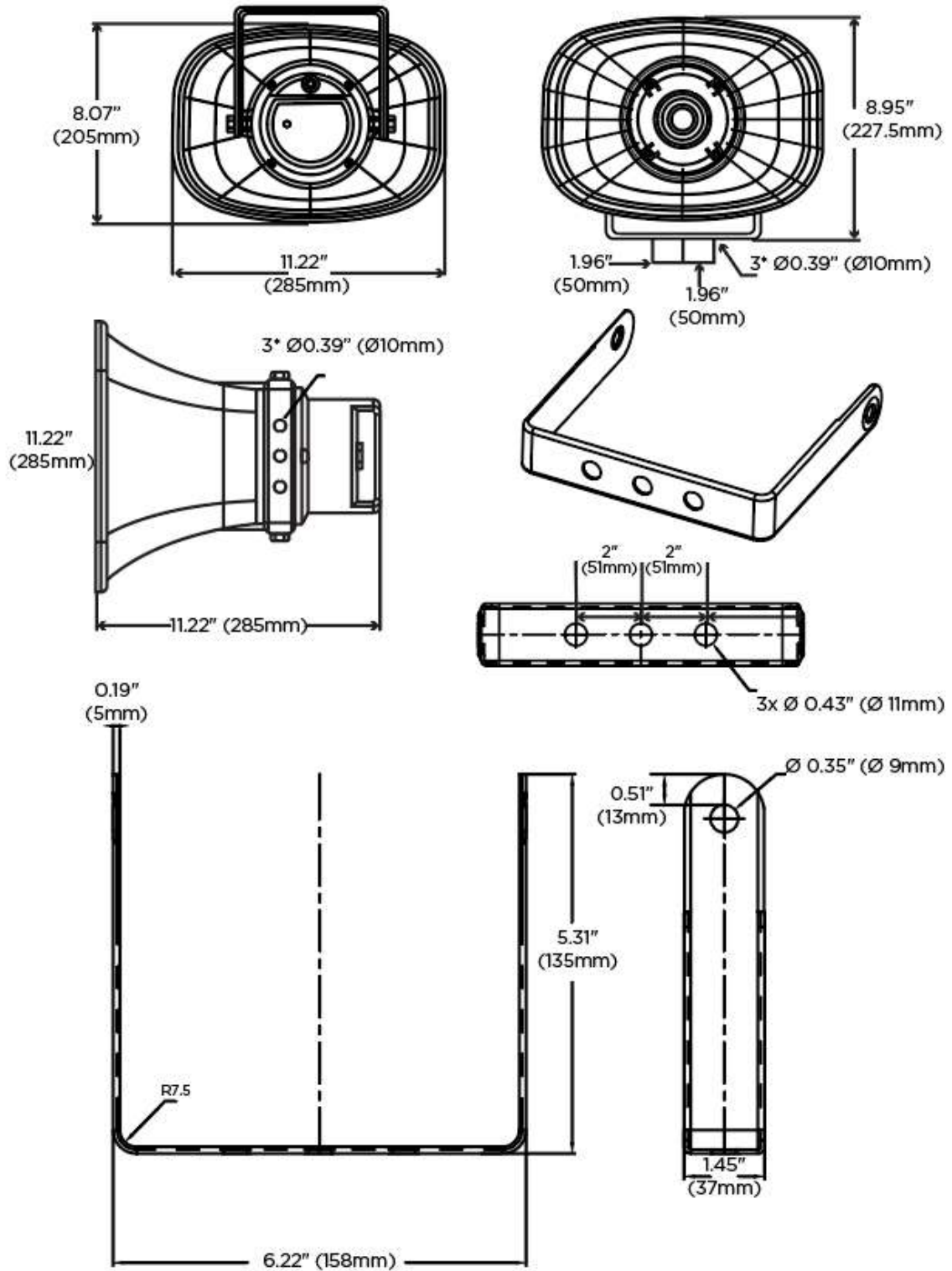

9. Warranty Information

Go to <https://digital-watchdog.com/page/rma-landing-page/> to learn more about Digital Watchdog's warranty and RMA.

To obtain warranty or out-of-warranty service, please contact a technical support representative at 1+ (866) 446-3595, Monday through Friday from 9:00 AM to 8:00 PM EST.

Before the warranty service is rendered, a purchase receipt or proof of the original purchase date is needed. This warranty only covers failures due to defects in materials and workmanship that arise during normal use. This warranty does not cover damages that occur in shipment or failures that are caused by products not supplied by the Warrantor or failures that result from accident, misuse, abuse, neglect, mishandling, misapplication, alteration, modification, faulty installation, setup adjustments, improper antenna, inadequate signal pickup, maladjustments of consumer controls, improper operation, power line surge, improper voltage supply, lightning damage, rental use of the product or service by anyone other than an authorized repair facility or damage that is attributable to acts of God.

10. Limits and Exclusions

There are no express warranties except as listed above. The Warrantor will not be liable for incidental or consequential damages (including, without limitation, damage to recording media) resulting from using these products or arising out of any breach of the warranty. All express and implied warranties, including the warranties of merchantability and fitness for a particular purpose, are limited to the applicable warranty period set forth above.

Some states do not allow the exclusion or limitation of incidental or consequential damages or limitations on how long an implied warranty lasts, so the above exclusions or limitations may not apply to you. This warranty gives you specific legal rights; you may also have other rights that vary from state to state.

If the problem is not handled to your satisfaction, then write to the following address:

Digital Watchdog, Inc.

ATTN: RMA Department

16220 Bloomfield Ave

Cerritos, CA 90703

Service calls that do not involve defective materials or workmanship as determined by the Warrantor, in its sole discretion, are not covered. The cost of such service calls is the responsibility of the purchaser.



Complete Surveillance Solutions

DW® East Coast office and warehouse: 5436 W Crenshaw St, Tampa, FL USA 33634
DW® West Coast office and warehouse: 16220 Bloomfield Ave, Cerritos, CA USA 90703

PH: 866-446-3595 | FAX: 813-888-9262

www.Digital-Watchdog.com

technicalsupport@digital-watchdog.com

Technical Support PH:

USA & Canada 1+ 866-446-3595

International 1+ 813-888-9555

French Canadian: + 1-904-999-1309

Technical Support Hours: Monday-Friday 9 a.m. to 8 p.m. Eastern Time