

# SiteWatch™ motion detectors

DW-DTMWIPW

DW-DTPIRIPW



***User's Manual*** Ver. 08/19



Before installing and using the camera, please read this manual carefully.

Be sure to keep it handy for future reference.

# Safety Information

## BEFORE OPERATION

This section of the manual uses the following warning symbols to provide information regarding use of the product to prevent you and others from being harmed and your product from being damaged. These warning symbols are described below. Ensure you understand these precautions before proceeding with the installation.







 <b>Warning</b>	Failure to follow the instructions provided by this warning and improper handling may cause death or serious injury
 <b>Caution</b>	Failure to follow the instructions provided by this caution and improper handling may cause injury and/or property damage



This symbol indicates prohibition. The specific prohibited action is provided in and/or around the figure.



This symbol requires an action or gives an instruction.

 <b>Warning</b>	
Never attempt to disassemble or repair the product. It may cause fire or damage to the devices.	
Hold the main unit securely when you install or service it. Exercise care not to bump the product against nearby objects or drop it inadvertently.	
 <b>Caution</b>	
Only use approved Power over Ethernet power supplies. Never try to power the device other than with the RJ45 PoE connection.	
Do not touch the unit connections with a wet hand or when the product is wet from rain. It may cause a short circuit and damage the unit.	
Clean and check the products periodically for safe use. If any problem is found, contact DW® or authorized partners to solve the issue before continuing to use the product.	
This product is intended to detect people and is not designed to prevent theft, disasters or accidents. The manufacturer shall not be held liable for any damage to user's property resulting from theft, disasters or accidents.	

# Contents

---

## **INTRODUCTION**

- 4 Package Contents
- 4 Dimensions

## **INSTALLATION**

- 5 Mounting the detector
- 5 Connecting the detector
- 6 Installing the detector
- 7 Multi-beam alignment and masking

## **PROGRAMMING**

- 9 Using the Programming Button
- 10 Web-based user interface
  - 10 General connection
  - 10 Default settings
  - 11 Sensor settings
  - 12 Device configuration
  - 13 Import and export settings
  - 14 Firmware update

## **ALARM SETTINGS**

- 15 Alarm inputs
- 16 Create Alarm Actions

## **17 WARRANTY**

## **18 LIMITS AND EXCLUSIONS**

# Introduction

---

## PACKAGE CONTENTS

- 1 x detector
- 1 x mounting template
- 3 x 1.25" (31.75mm) wall anchors and washers
- 2 x spare sliding curtains
- 1 x tamper feet 0.039" (1mm) long
- 1 x tamper feet 0.078" (2mm) long
- 1 x quick setup guide

## DETECTOR DIMENSIONS

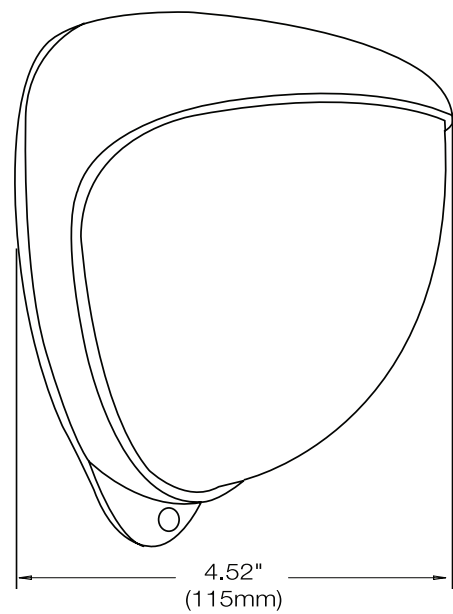
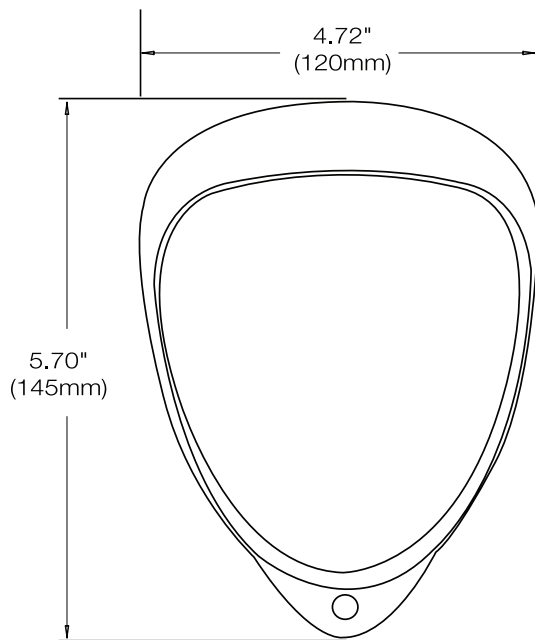

# Installation

## MOUNTING THE DETECTOR

During installation, protect the electronics from water. Trapped moisture can affect or damage the unit.

1. Find the suitable location to install the SiteWatch™. The sensor should be positioned so the person will pass across the field of view and not directly toward or away from it.
2. Using the mounting template sheet or the detector itself, mark and drill the necessary holes in the wall. It is recommended to use the tamper cup on uneven wall surfaces.

**Suggested mounting height of 10ft is recommended.**

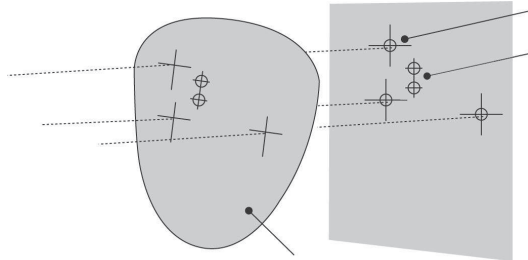

3. Remove the cover assembly by loosening the locking screw. The cover hinges from the top and lifts out of the location slot.

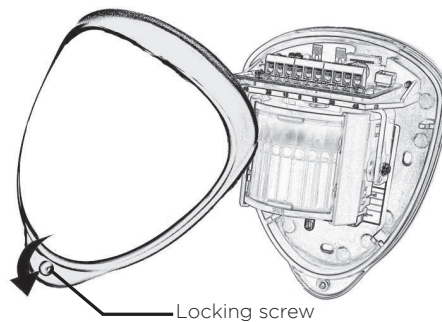

## CONNECTING THE DETECTOR

1. Pass the CAT5e/CAT6 cable through the cable entry from outside to inside.
2. Install the Cat5e / Cat6 through the provided hole on the rear of the detector. Terminate the Cat5e / Cat6 cable using an RJ46 connector leaving enough cable to connect to the RJ45 port. Refer to the image below.
3. Plug the connector into the RJ45 port. Refer to the image below.

\* Tools are required to crimp RJ45 connector. RJ45 Connector not included.

Use the diagram below to connect your detector to the necessary external devices.

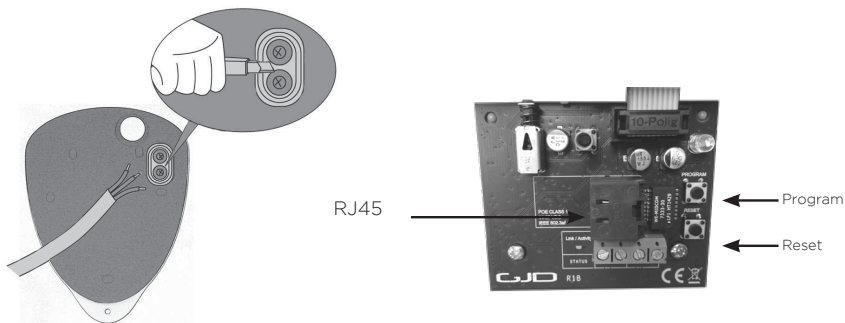

# Installation

---

## INSTALLING THE DETECTOR

1. The nylon washers provided must be used with screws.
2. Ensure cable entry and screw holes are sealed with water-based sealant. Do not use silicone-based sealant.

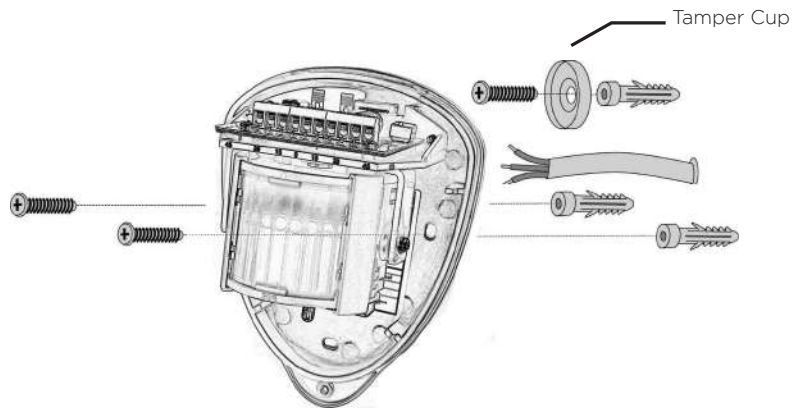

3. Screw the unit to the wall ensuring that the rear tamper pin is correctly located and that the tamper micro switch is closed.
4. To aid installation, two spare tamper feet are provided. One is 0.04" (1mm) longer and the other is 0.08" (2mm) longer than the tamper foot originally fitted. The tamper foot is a push fit and can be removed by carefully pulling it from the pin.
5. When the detector is aligned, connected, and programmed to suit the installation, close the front cover and lock as shown.



# Installation

## MULTI BEAM ALIGNMENT AND MASKING

The multifunction lens fitted to the SiteWatch™ detectors produces seven long-range beams and seven medium- to short-range curtain PIR beams. The Passive infra-red (PIR) circuitry detects changes in heat and movement in the beam pattern. Items such as trees, shrubs, ponds, chimney and animals should be considered when positioning the detector. The detector is fitted with a mirror on the pyro sensor to provide a detection zone directly underneath the detector.



Note: The maximum mounting height is 10ft (3m) when utilizing the creep detection zone.

When using the pet immune configuration the mirror should be removed.

**Note: The PIR sensor is more sensitive to movement across the beams, and less sensitive to movement directly towards or away from the beams.**

The detector module is fitted with two sliding shutters to reduce the detection angle. The curtains are fitted to the pan and tilt module as shown below. Each section of the detector lens gives a coverage pattern of approximately 10°.

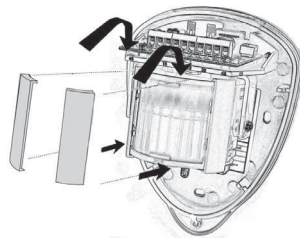

An additional set of curtain sliders is provided if the beam pattern needs to be narrowed further (for example, if the minimum detection angle of 10° is required). When coverage exceeds the desired detection area, adjust the module as required and mask off any beams, either vertically or horizontally, to avoid unwanted detection.

Use portions of the self-adhesive silver mask applied to the rear, smooth side of the lens as shown in the diagrams below. Always replace the lens the correct way up to ensure exact beam pattern coverage (top of the lens is marked TOP).

### BEAM PATTERN SET TO MAXIMUM RANGE

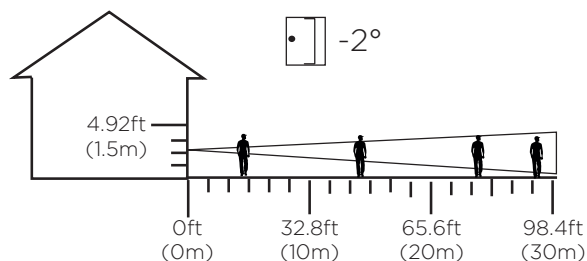
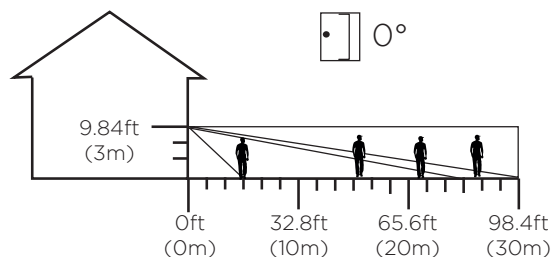
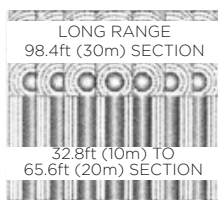

# Installation

When mounted at heights above 10ft (3m), there could be a significant reduction in the range of detection. The target will have to move a greater distance within the detector's field of view before an alarm is generated.

The figure below shows the pattern for the maximum (left) and minimum (right) range in the optimum position. On the maximum range diagram, masking the top section of the lens reduces the range to 65.6ft (20m). For minimum range installations, please refer to the following diagram. In this case, masking the top section of the lens reduces the range to 6 meters.

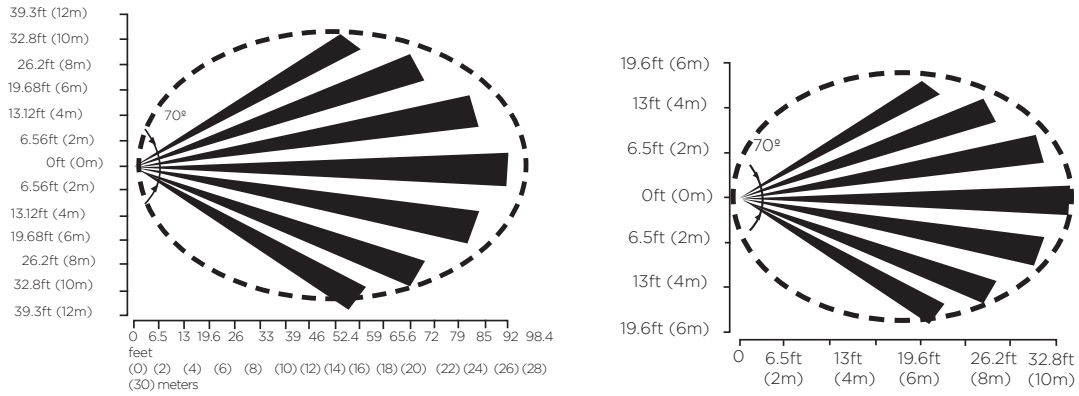

The following two diagrams address alignment recommendations for when the detector is mounted close to a wall. If the detector module is orientated at 90° to the perimeter, the mounting wall may cut off short- and medium-range beams.

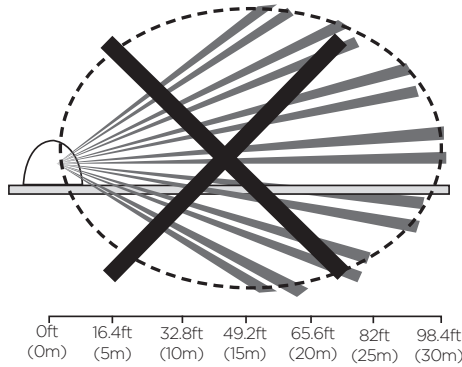

The long-range beam will still detect an intruder, however the wall can cause false alarms when heated by sunlight. Below is the recommended alignment when mounted next to a wall. The detector module is orientated at 55° to the perimeter. As a result, short- and medium-range beams are parallel to the perimeter, but the detection range along the perimeter is reduced to 82ft (25m).

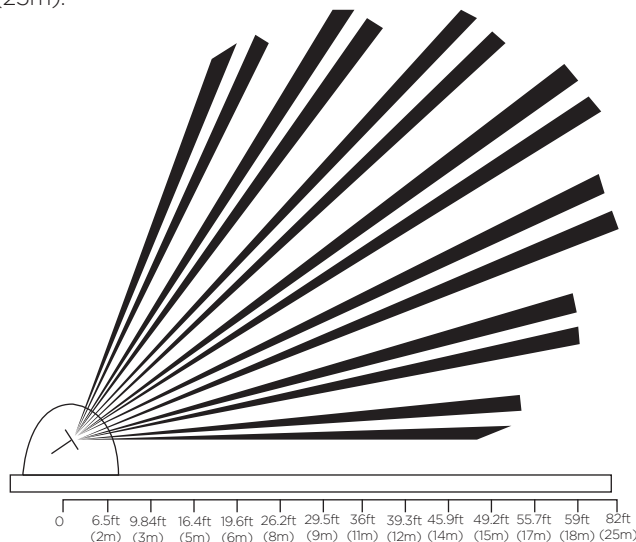

# Programming - using the programming button

## PROGRAMMING

There are 2 ways to program the detector's detection range, pulse count and LED setting.

1. Using the programming button on the detector itself and programming chart below.
2. Using the detector's web-based interface.

## USING PROGRAMMING BUTTON

### Programming Chart

		SETTING					
		1	2	3	4	5	
O P T I O N S	1	RANGE (m)	8	15	20	25	30
	2	Pulse Count	1	2	3		
	3	LED	Off	On			

To change any of the SiteWatch™ detectors settings:

1. Press the program button (as shown in the image below) for the number of the Option to be changed. For example, press once for range, twice for pulse count, three times for LED settings.

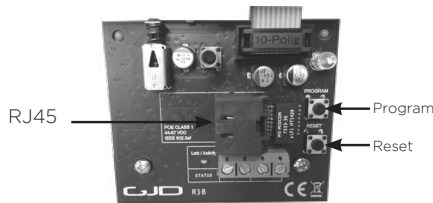

2. Wait until the blue LED indicator turns off (four seconds).
3. The indicator will then flash out the existing settings.
4. To change the settings for the set option, press the program button the number of times for the required new setting.
5. The indicator will blink twice and the changes will be saved in the SiteWatch™ detectors' non-volatile memory.

Example: to change the LED setting from OFF to ON:

1. Press the program button three times to enter the LED settings options.
2. Wait until the blue LED indicator turns off (four seconds).
3. The indicator will then flash once, indicating the current LED setting is OFF.
4. Press the program button twice to change the setting to ON.
5. The indicator will blink twice and the changes are saved in the SiteWatch™ detectors' non-volatile memory.

## PROGRAMMING OPTIONS DEFINITIONS

### Pulse Count

The number of times the detector must detect motion on both of its sensors before signaling an output.

### LED

LED Off - LED signals are detection is disabled.  
LED On - LED signals a detection is enabled.

### Relay outputs

Output 1 and output 2

These are magnetically immune volt-free relay contacts, used to trigger alarm inputs on connected equipment. The contacts are rated at a maximum of 24V AC/DC @ 50mA.

The contact operating timer can be adjusted in the web-based user interface.

### WALK TEST

In walk test mode, the detection LED option is set to ON, and the pulse count option is set to 1. DW-DTWT walk tester is sold separately.

1. The detection LED turns on each time the SiteWatch™ detectors detect motion.
2. To enter the walk test mode, press the programming button once. The detection LED is enabled and pulse count 1 is automatically selected. The walk test mode can also be entered via the web-based user interface. The unit can then be aligned. See the DW-DTWT QSG for more information.
3. The test mode ends automatically five minutes after the last activation. Alternatively, press the program button three times, to cancel the walk test mode.

**Note: When conducting a walk test, make sure that the front cover of the detector is in place. Do not conduct walk tests with the cover removed.**

The range of the detector increases without the protective front cover. Therefore, the front cover must be fitted to establish the correct beam pattern. Use the programming chart to adjust the range as necessary. Pan and tilt the lens module over the field of view to obtain the correct coverage area.

### Microwave Frequencies

DW-DTMWIPW ONLY: 10.525GHz  
10 dBm EIRP

# Programming - web-based user interface

---

## GENERAL CONNECTION

1. Connect the network cable to the detector and verify that the unit powers-up and the network connection is working.

## FACTORY RESET

1. Make sure the detector is powered on.
2. Hold down the reset button for 8 seconds.
3. Release reset button, the status LED on the board will turn off for a second.
4. The unit's IP address and login details are now reset back to factory values.

## USER INTERFACE

Settings are adjusted through the web-based user interface. All that is needed is a modern web browser to access and change settings.

## FACTORY DEFAULT SETTINGS

When using the system for the first time, or if a factory reset has been made, the following are the detector's default network settings:

**IP address:** 192.168.1.10

## LOGIN

1. Open a web browser.
2. In the address field, enter in the detector's IP address. The default IP address is 192.168.1.10.
3. The user interface login page will appear as shown below.

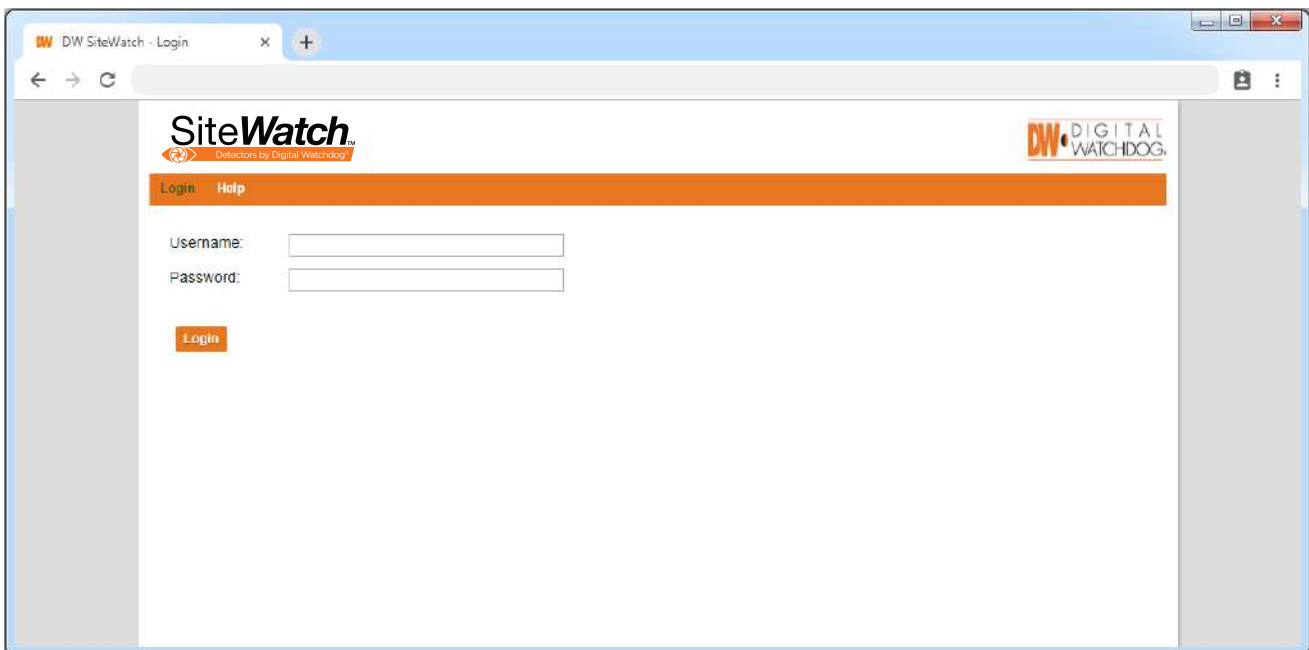

4. When connecting to the detector for the first time, you will be prompted to create a username and password.

# Programming - web-based user interface

## SENSOR SETTINGS

1. Open the 'sensor settings' tab.
2. To change any of the detector's range, pulse count and detection LED settings, use the drop-down boxes to select the required setting. Changes are saved automatically.
3. Press the 'factory default' button and then 'save settings' to restore the detector to its default range, pulse count and LED settings.
4. 'Sensor status' displays the detector's current passive infra-red (PIR), lux level, tampering and temp status. This is live data and cannot be modified.
5. To enter the walk test mode, press the 'walk test ON' button. To exit the walk test mode, press 'walk test OFF'.
6. You can also manually adjust the 2 digital outputs to open or closed settings.

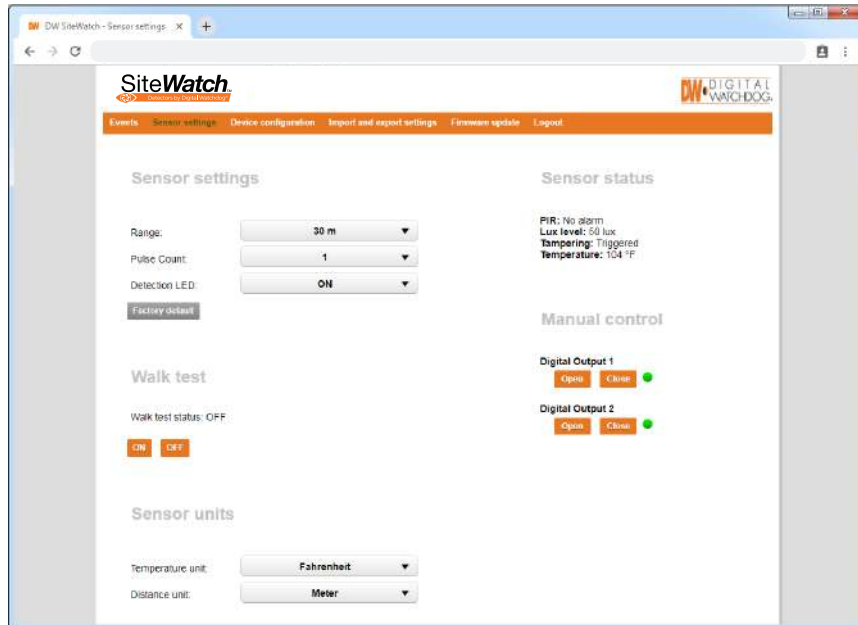

# Programming - web-based user interface

## DEVICE CONFIGURATION

1. Open the 'device configuration' tab.
2. This tab shows the detector's current TCP/IP, HTTPS and user login settings.
3. The detector supports static IP information. This means you will have to manually enter the proper IP address, subnet mask and default gateway to match the network's settings.
4. If needed, enter the HTTP and HTTPS server ports and host-name.
5. If the SiteWatch™ detectors are integrated with Control4, use the 'identify' and 'save and reset' buttons to control the unit as needed.
6. You can upload and update the detector's TLS certificate and private key for HTTPS settings. You can also load the detector's default certificate or restart the HTTPS settings.

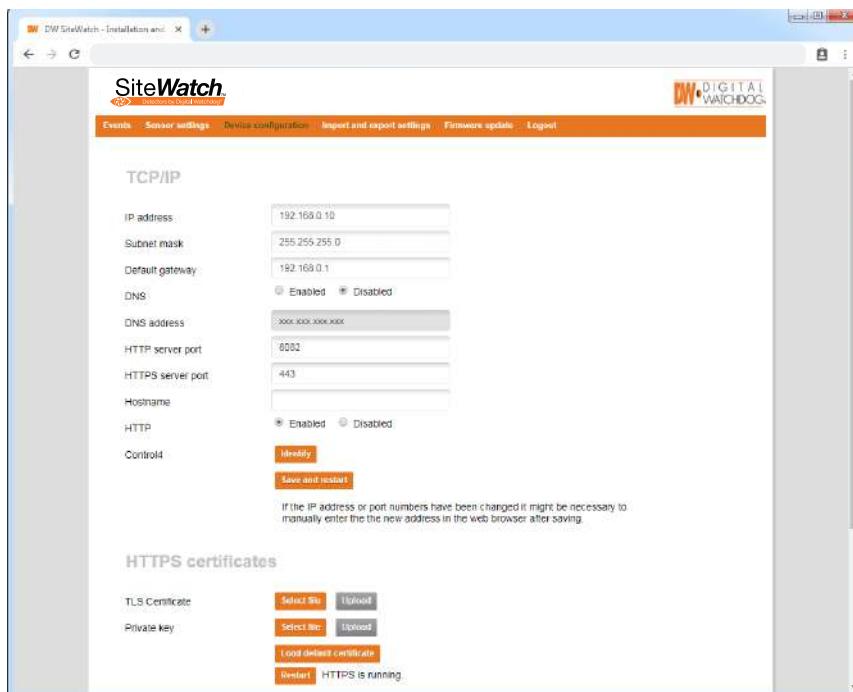

7. If changes have been made to the detector's network settings, you will have to reload the page with the new IP address if changed.
8. To change the current user's password, enter the new password according to the recommended instructions and click 'save'.

## Login

The password must have at least 8 characters and at least three of the following groups; small letters, capital letters, numbers, special characters.

Username

Password

Confirm password

# Programming - web-based user interface

## IMPORT AND EXPORT SETTINGS

You can download the detector's current settings and use them to setup other detectors. The detector's alarm settings and I/O configuration will be exported as a CFG file. Network and login settings are not included in the exported file.

1. Open the 'import and export settings' tab.
2. Export all current alarm settings and I/O configuration by pressing the 'download settings' button. Select the file location on your hard drive as needed. The file name is unique for each detector and includes the detector's MAC address.
3. Use the import settings section to import the alarm and I/O settings from another detector as needed. Select the file from your hard drive and press the 'upload settings' button.

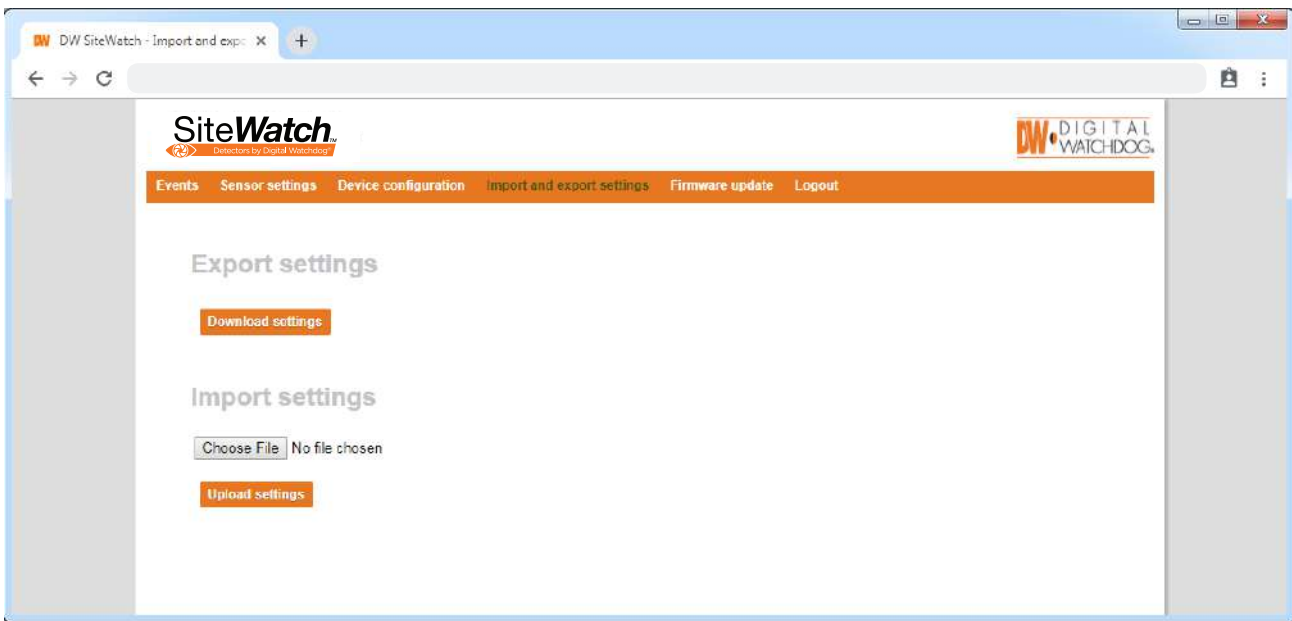

# Programming - web-based user interface

## FIRMWARE UPDATE

The SiteWatch™ detector's firmware should be updated when new versions are available. To update the detector's firmware:

1. Open the 'firmware update' tab. The current firmware version is displayed.
2. Press the 'select firmware file' button. Locate the firmware file on your hard drive and click open.
3. Click 'upload firmware'.
4. When the firmware update is complete, the detector's web-based user interface will return to the login page.

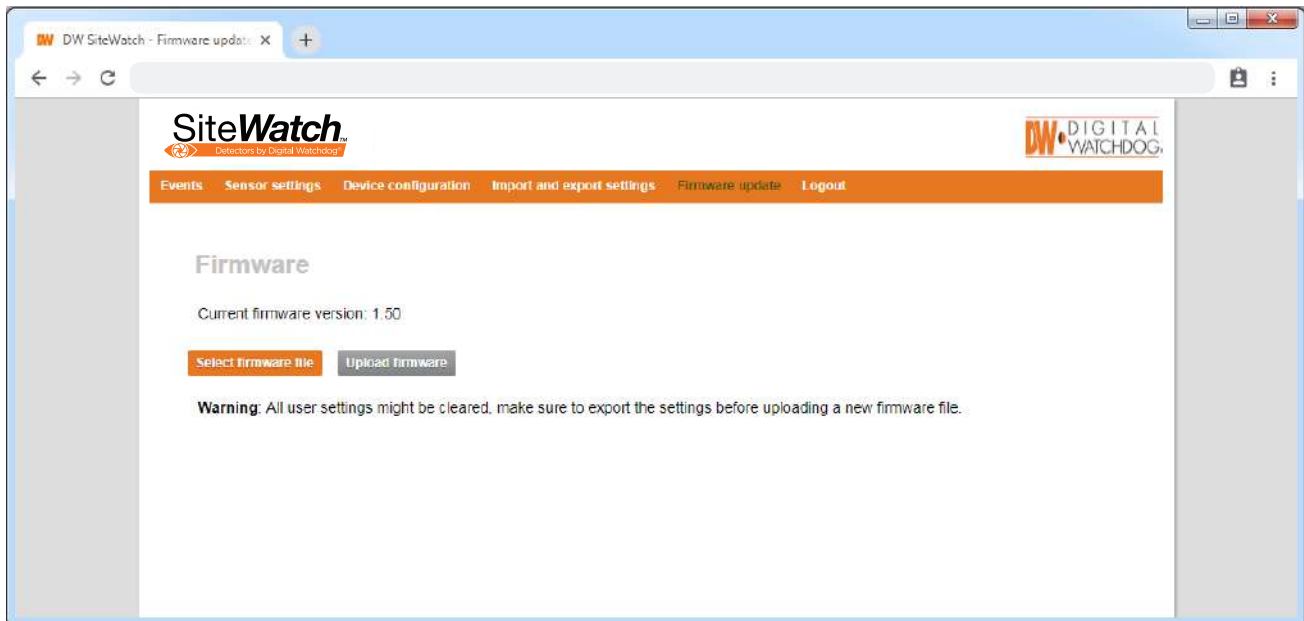

# Alarm settings

## ALARM SETTINGS

All alarm settings can be made and managed in the 'events' tab. The SiteWatch™ detectors work on the "Alarm - Action" principle. Alarms are created based on all types of input signals. For each alarm, it is possible to create one or more actions. The actions can be a network alarm message or to trigger a relay.

### Alarm inputs

1. Go to 'events' tab.
2. Press 'add event'.
3. Enter a unique alarm name.
4. From the input drop-down menu, choose the action to generate the alarm. Select from the available options:

**Delay** Alarm delay specifies the time for which the alarm conditions must be continuously fulfilled before the alarm is enabled. Default value is 0 seconds, maximum is 120 seconds.

**Time-out** Specifies the time before an alarm is disabled after the alarm conditions are no longer met. Default value is 0 seconds, maximum is 120 seconds.

**Alarm activation** Always - Alarm is always active  
Above light limit - Alarms will become active when the lux level is above the light limit setting.  
Below light limit - Alarms will become active when the lux level is below the light limit setting.

**Light limit** The light level (lux) that the Above and Below light limits react.

5. Press the Add event button to save.
6. Repeat step 2 to 6 for all required alarm actions.

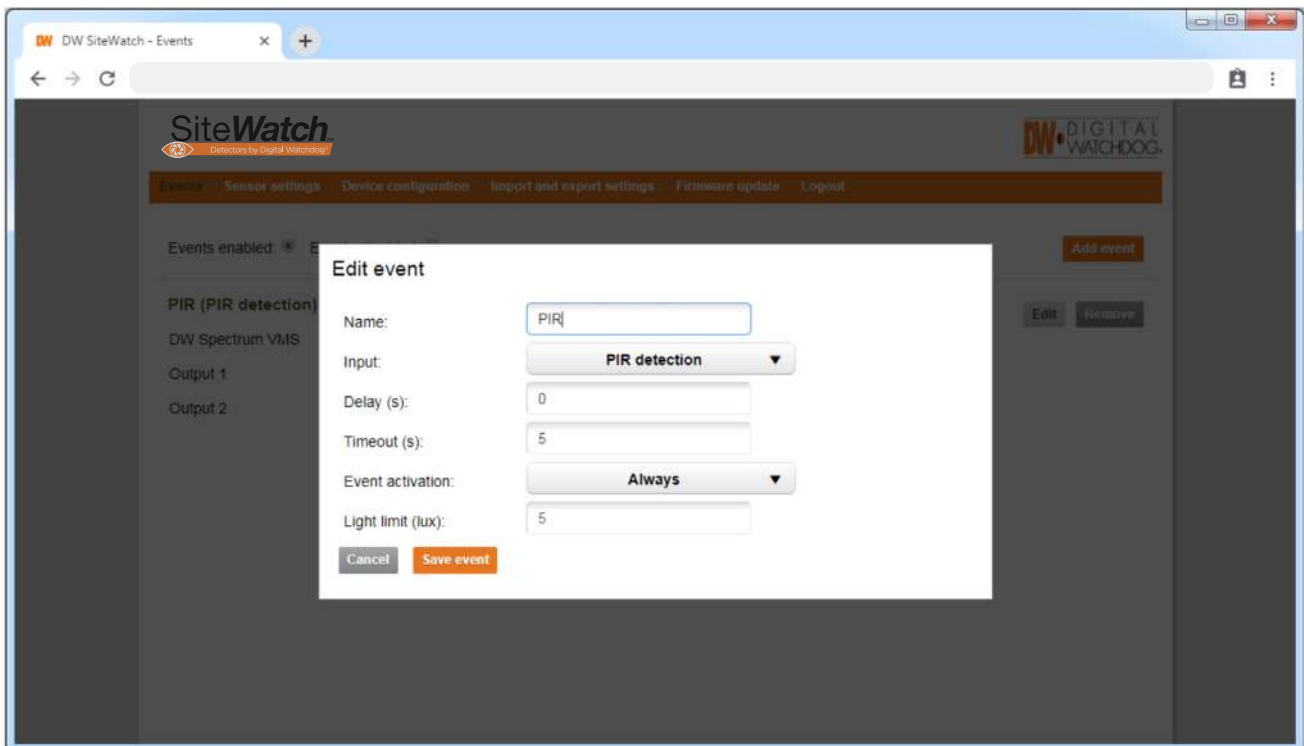

# Create Alarm Actions

## CREATE ALARM ACTIONS

1. Press 'add action' under the desired alarm. Input fields appear to the right.
2. Choose the action type from the 'event type' drop-down menu:

**Output 1** This turns output 1 on when the detector is activated and turns it off when the alarm clears.

**Output 2** This turns output 2 on when the detector is activated and turns it off when the alarm clears.

**Connect to URL** Connect to URL is used to create any type of network alarm. This allows one URL request at alarm enable and one URL request at alarm disable.

**DW Spectrum® IPVMS** Connect to a DW Spectrum® IPVMS client to create any type of network alarm.

**Partner list** The products listed have a built-in wizard in the detector that creates the specific URL request needed for the application.

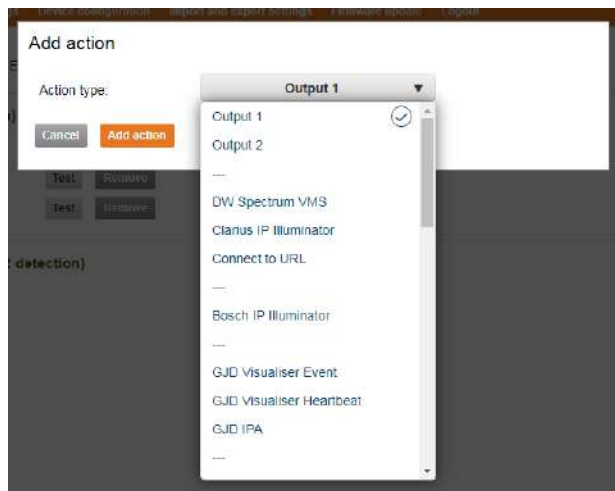

3. Fill in required data fields for the selected event type.
4. Press the 'add action' button to save.
5. You can test, remove or edit any action by using the buttons next to it.
6. Repeat step 1-5 for each alarm.

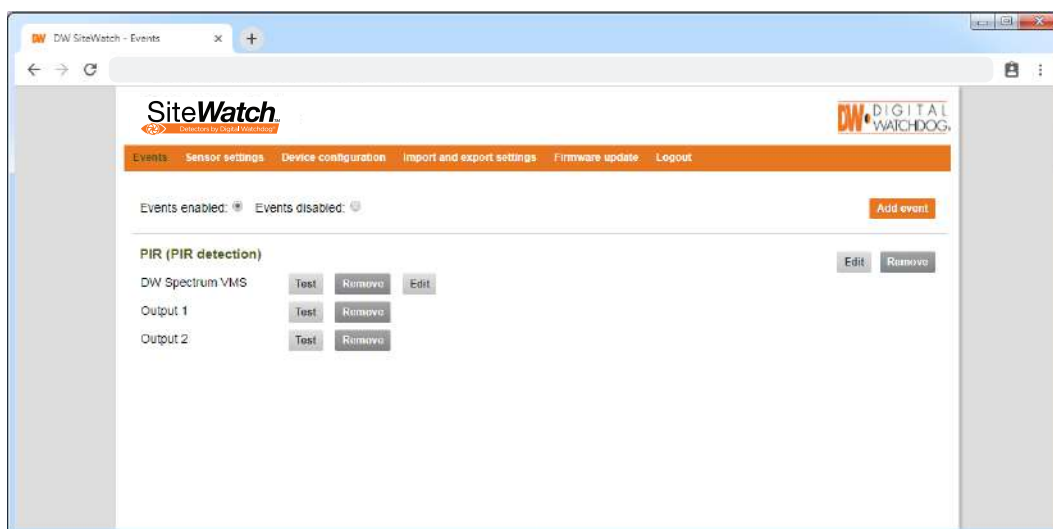

# Warranty Information

---

**Digital Watchdog** (referred to as “the Warrantor”) warrants the motion detector against defects in materials or workmanships as follows:

**Labor:** For the initial two (2) years from the date of original purchase if the camera is determined to be defective, the Warrantor will repair or replace the unit with new or refurbished product at its option, at no charge.

**Parts:** In addition, the Warrantor will supply replacement parts for the initial two (2) years.

To obtain warranty or out of warranty service, please contact a technical support representative at 1+ (866) 446-3595, Monday through Friday from 9:00AM to 8:00PM EST.

A purchase receipt or other proof of the date of the original purchase is required before warranty service is rendered. This warranty only covers failures due to defects in materials and workmanship which arise during normal use. This warranty does not cover damages which occurs in shipment or failures which are caused by products not supplied by the Warrantor or failures which result from accident, misuse, abuse, neglect, mishandling, misapplication, alteration, modification, faulty installation, set-up adjustments, improper antenna, inadequate signal pickup, maladjustments of consumer controls, improper operation, power line surge, improper voltage supply, lightning damage, rental use of the product or service by anyone other than an authorized repair facility or damage that is attributable to acts of God.

# Limits & Exclusions

---

There are no express warranties except as listed above. The Warrantor will not be liable for incidental or consequential damages (including, without limitation, damage to recording media) resulting from the use of these products, or arising out of any breach of the warranty. All express and implied warranties, including the warranties of merchantability and fitness for particular purpose, are limited to the applicable warranty period set forth above.

Some states do not allow the exclusion or limitation of incidental or consequential damages or limitations on how long an implied warranty lasts, so the above exclusions or limitations may not apply to you. This warranty gives you specific legal rights, and you may also have other rights from vary from state to state.

If the problem is not handled to your satisfaction, then write to the following address:

Digital Watchdog, Inc.  
ATTN: RMA Department  
16220 Bloomfield Ave  
Cerritos, CA 90703

Service calls which do not involve defective materials or workmanship as determined by the Warrantor, in its sole discretion, are not covered. Cost of such service calls are the responsibility of the purchaser.



*Complete Surveillance Solutions*

Headquarters Office: 5436 W Crenshaw St, Tampa, FL 33634

Sales Office: 16220 Bloomfield Ave., Cerritos, California, USA 90703

PH: 866-446-3595 | FAX: 813-888-9262

[www.Digital-Watchdog.com](http://www.Digital-Watchdog.com)

[technicalsupport@dwcc.tv](mailto:technicalsupport@dwcc.tv)

Technical Support PH:

USA & Canada 1+ (866) 446-3595

International 1+ (813) 888-9555

French Canadian 1+ (514) 360-1309

Technical Support Hours: Monday-Friday

9:00am to 8:00pm Eastern Standard Time