

GV-LPR2800-DL 2 MP H.265 Super Low Lux WDR Pro LPR Box IP Camera



- Built-in deep learning LPR processor for license plate recognition
- Double-lane recognition
- 1/2.8" progressive scan super low lux CMOS
- Min. illumination at 0.04 lux
- Triple streams from H.265, H.264 and MJPEG
- Up to 60 fps at 1920 x 1080
- Intelligent IR
- IR distance up to 30 m (100 ft)
- Day and Night function (with removal IR-cut filter)
- Wide Dynamic Range Pro (WDR Pro)
- DC 12 V / PoE (IEEE 802.3bt)
- Ingress protection (IP68)
- Vandal resistance (IK10 for metal casing)
- Two-way audio
- Built-in micro SD card slot (SD/SDHC/SDXC/UHS-I, Class 10) for local storage
- Digital I/O (2 in / 2 out)
- Built-in heater and fan
- Recognize vehicles with speeds up to 100 km/h (62 mph)
- Standalone database
- Recognized plate numbers export
- LPR results overlaid on recognition images
- Defog
- Motion detection
- Privacy mask
- IP address filtering
- Mobile AP support (iOS & Android)
- 31 languages on Web interface
- CE, FCC, LVD, RoHS compliant
- TAICS IoT Cyber Security **Level 2** certified (suitable for commercial use)

*Optional [GV-PA902BT Gigabit PoE Adapter](#) is required for applying the PoE function.

Deep-Learning LPR Camera

GV-LPR2800-DL is capable of recognizing license plate numbers with its built-in deep learning LPR processor. GV-LPR2800-DL can compare captured license plates either with its on-the-edge standalone database, or the database stored at the GV-ASManager access control system. When there is a match, GV-LPR2800-DL can grant access for the vehicle by opening a gate or barrier.

GV-LPR2800-DL is a 2 MP color network camera designed to recognize non-reflective and reflective license plates on vehicles traveling at up to 100 km/h (62 mph). Thanks to its multiple high-power LEDs and intelligent IR, the camera can automatically adjust its shutter speed to the scene and capture clear license plate images in low-light settings. It adheres to IP68 and IK10 standards and can withstand temperatures ranging from -40°C (-40°F) to 50°C (122°F).

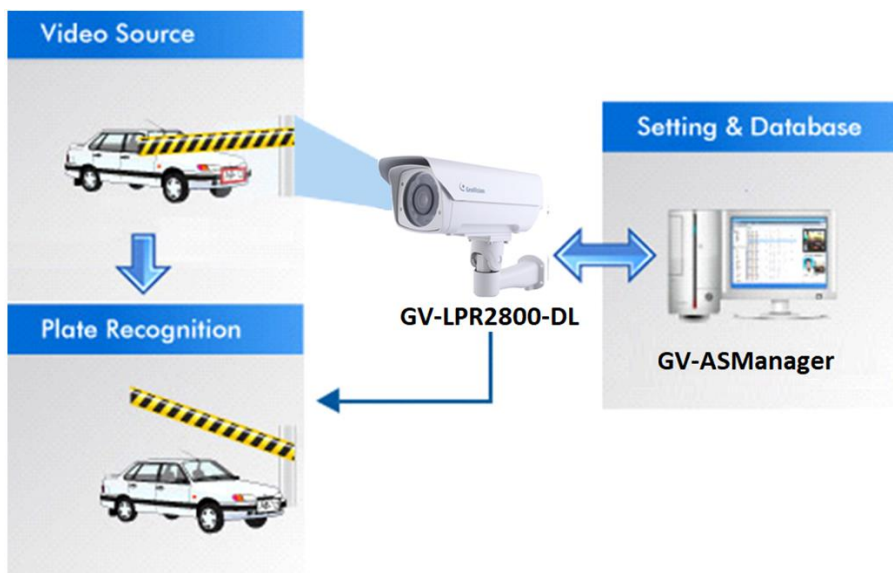

Dimensions

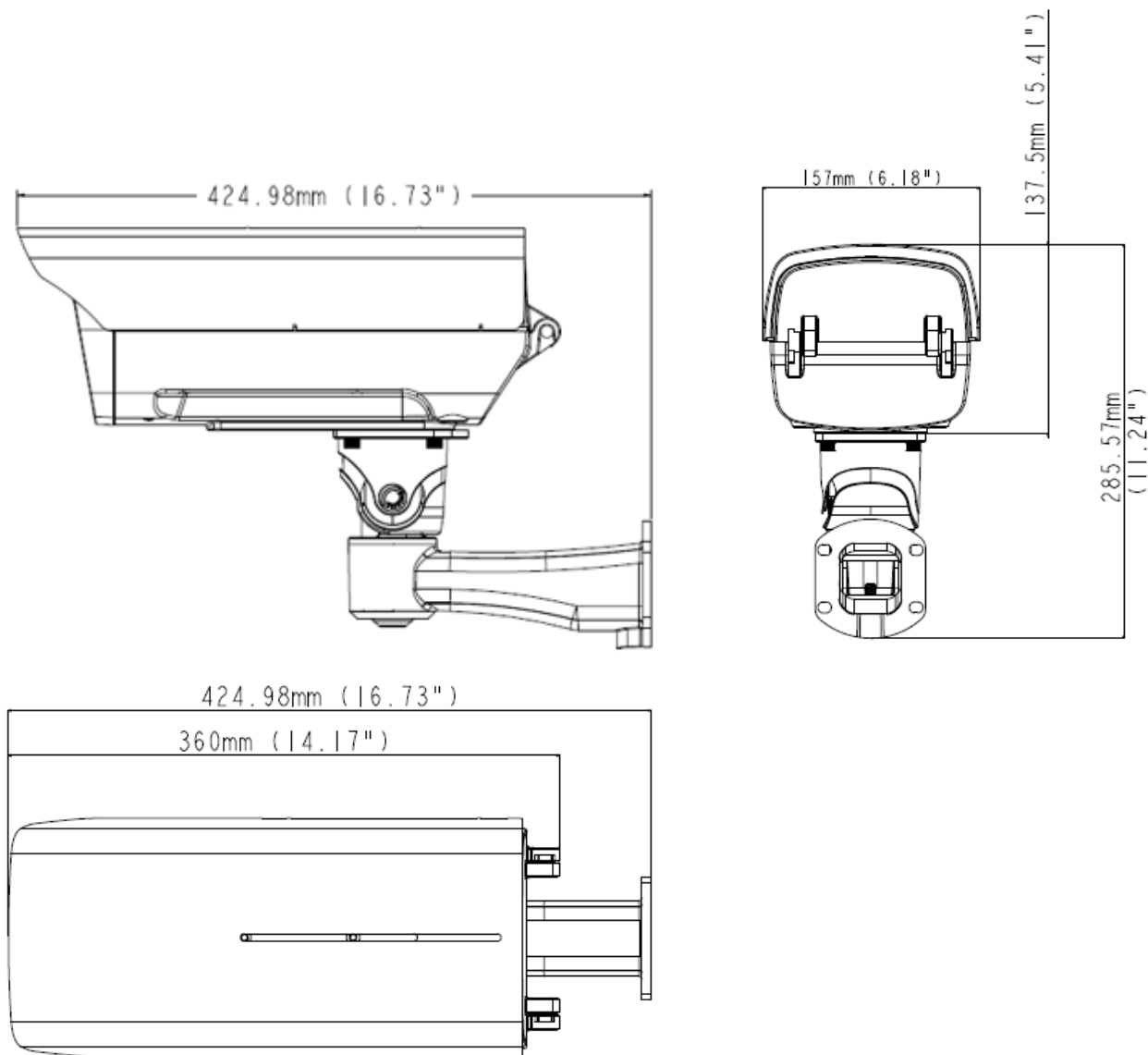







Specifications

Camera		
Image Sensor		1/2.8" progressive scan super low lux CMOS
Minimum Illumination	Color	0.05 lux
	B/W	0.04 lux
Picture Elements		1920 (H) x 1080 (V)
Shutter Speed		Automatic: 1/500 ~ 1/16,000 sec Manual: 1/120 ~ 1/16,000 sec
S/N Ratio		56 dB
WDR Pro		Yes
Dynamic Range		130 dB
Max. Speed		100 km/h (62 mph)
Lens		
Megapixel		2 MP
Day/Night		Yes (with removable IR-cut filter)
Lens Type		Varifocal
Focal Length		5 ~ 50 mm
Horizontal FOV		50.9° ~ 7.6°
Maximum Aperture		F/1.6
Mount		CS Mount
Image Format		1/2.7"
Operation	Focus	Manual (w/lock)
	Zoom	Manual (w/lock)
	Iris	DC-Iris
IR LED Quantity		10 high power IR LEDs
IR Distance		30 m (100 ft)
Operation		
Video Compression		H.265, H.264, MJPEG
Video Stream		Triple streams from H.265, H.264 and MJPEG
Frame Rate		60/50 fps at 1920 x 1080 (60/50 Hz) * The frame rate and the performance may vary depending on the number of connections and data bitrates (different scenes)
Image Setting		Brightness, Contrast, Saturation, Sharpness, Gamma, White Balance, Flicker-less, Image Orientation, Shutter Speed, Backlight Compensation, D/N Sensitivity, Defog, Denoise, Metering
Audio Compression		G.711
Audio Support		Two-way audio (external microphone and speaker required)
Digital I/O		2 In / 2 Out
Video Resolution		
Main Stream	4:3	1280 x 960
	16:9	1920 x 1080 (Default), 1280 x 720
Sub Stream	4:3	1024 x 768, 640 x 480, 320 x 240
	16:9	1280 x 720, 640 x 360 (Default), 448 x 256
Third Stream	4:3	640 x 480, 320 x 240
	16:9	640 x 360, 448 x 256
Network		
Interface		10/100/1000 Base-T Ethernet, RJ-45 connector
Protocol		DHCP, DNS, DynDNS, FTP, HTTP, HTTPS, ICMP, IPv4, IPv6, Multicast, NTP, QoS (DSCP), RTCP, RTSP, SNMP, SMTP, SSL, TCP/IP, UDP, UPnP, 3GPP/ISMA
Security Feature		- No default ID and Password - 802.1x authentication - HTTPS with SSL certificate stored within the camera - 256-bit AES encryption (requires working with GV-VMS V18.1 or later)

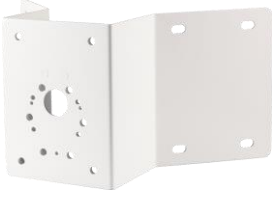
Mechanical		
Temperature Detector		Yes
Camera Adjustment	Pan	0° ~ 330°
	Tilt	0° ~ 90°
Connectors	Power	2-pin terminal block
	Ethernet	Ethernet (10/100/1000 Base-T), RJ-45 cable
	Audio	1 In (microphone jack, 3.5 mm / 0.14") 1 Out (phone jack, 3.5 mm / 0.14")
	Digital I/O	2 In / 2 Out
	RS-485	RS-485+ / RS-485- (for recognition data output)
Local Storage	Micro SD card slot (SD/SDHC/SDXC/UHS-I, Class 10) * UHS-II card types not supported.	
LED Indicator		N/A
LPR		
Min Height of License Plates		40 pixels
Region of License Plate		Czech, Europe, France, Germany, Hungary, Italy, Israel, Lithuania, Myanmar, Netherlands, Romania, Slovakia, Taiwan, UK, Ukraine, US (California, Georgia), Vietnam
General		
Operating Temperature		-40 °C ~ 50 °C (-40 °F ~ 122 °F)
Humidity		10% ~ 90% (non-condensing)
Power Source		DC 12 V, 5A / PoE (IEEE 802.3bt)
Max. Power Consumption		45 W
Dimensions		360 x 157 x 137.5 mm (14.17" x 6.18" x 5.41")
Weight		4.34 kg (9.57 lb)
Cable Length		1 m (3.28 ft)
Ingress Protection		IP68
Vandal Resistance		IK10 for metal casing
Heater On		-40°C ~ 5°C (-40°F ~ 41°F)
Fan		Constantly on
Regulatory		CE, FCC, RCM, RoHS compliant
Power over Ethernet		
PoE Standard		PoE (IEEE 802.3bt / PD)
PoE Power Supply Type		End-span and Mid-span
PoE Power Output		Per Port 54 V DC, 1.2 A, Max. 60 W
Web Interface		
Installation & Management		Web-based configuration
Firmware Upgrade		Firmware upgrade through Web Browser or Utility
Access from Web Browser		Live View, Video Recording, Change Video Quality, Bandwidth Control, Image Snapshot, Audio, Picture in Picture, Picture and Picture, Privacy Mask, Text Overlay, Digital PTZ
Language		Arabic / Bulgarian / Czech / Danish / Dutch / English / Finnish / French / German / Greek / Hebrew / Hungarian / Indonesian / Italian / Japanese / Lithuanian / Norwegian / Persian / Polish / Portuguese / Romanian / Russian / Serbian / Simplified Chinese / Slovakian / Slovenian / Spanish / Swedish / Thai / Traditional Chinese / Turkish
Applications		
LPR Management		GV-ASManager V5.3.0 or later
Software Supported		GV-DVR / NVR (V8.8.0), GV-VMS (V17.4.0 / V18.2.0), GV-Control Center (V3.8.0), GV-Center V2 / Vital Sign Monitor (V18.2.0), GV-Edge Recording Manager for Windows (V1.4.0), GV-Recording Server / Video Gateway (V2.0.0), GV-Redundant / Failover Server (V1.1.0.0)
Smart Device Access		GV-Eye for Android and iOS
Live Viewing		Browser (IE, Chrome, Firefox, Safari), Mobile app

Note: Specifications are subject to change without notice.

Accessory

Model No.	Name		Details
GV-Mount300-1	Convex Corner Mount		Dimensions: 238.6 x 395.2 x 210 mm (9.4 x 15.5 x 8.2") Weight: 4.27 kg (9.41 lb)
GV-Mount310-1	Concave Corner Mount		Dimensions: 111.2 x 369.9 x 210 mm (4.37 x 14.5 x 8.2") Weight: 2.96 kg (6.53 lb)
GV-Mount400-1	Pole Mount Bracket (\varnothing 4 ~ 6")		Bracket: 68.4 x 240 x 163 mm (2.69 x 9.44 x 6.41") Weight: 1.70 kg (3.75 lb) Steel Strap Diameter: \varnothing 101 ~ 152 mm (4 ~ 6")
GV-Mount410-1	Pole Mount Bracket (\varnothing 6 ~ 7.5")		Bracket: 68.4 x 240 x 163 mm (2.69 x 9.44 x 6.41") Weight: 1.70 kg (3.75 lb) Steel Strap Diameter: \varnothing 152 ~ 191 mm (6 ~ 7.5")
GV-PA902BT	PoE Power Adapter		GV-PA902BT is an IEEE802.3af/at/bt PoE adapter, with a maximum power output of 95 W, that can be used to power GV-IP devices while providing Internet connection via an Ethernet cable.
GV-Relay V2			GV-Relay V2 is designed to expand the voltage load of GV-IP devices. It provides 4 relay outputs, and each can be set as normally open (NO) or normally closed (NC) independently as desired.
Power Adapter			Contact our sales representatives for the countries and areas supported.

Packing List

- GV-LPR2800-DL Camera
- Sun Shield Cover
- Sun Shield Cover Short Screw x 2
- Screw Anchor x 4
- 1/4"-10 Screw (32 mm) x 4
- M4 Screw (5 mm) x 2
- Washer x 4
- Hex Wrench
- Silica Gel Bag
- Adhesive Tape for Silica Gel Bag
- micro SD card (already inserted and formatted)
- Installation Guide
- Download Guide