

E217

2MP Box with D/N, Extreme WDR, SLLS, Fixed Lens



- 2 Megapixel
- Day & Night with Superior Low Light Sensitivity
- Fixed Lens with f2.93mm/F2.0
- Extreme WDR
- Super wide angle
- Event trigger, response and notification

► Specifications

Device

Product Type	Box
Maximum Resolution	2MP
Application Environment	Indoor/Outdoor
Image Sensor	Progressive Scan CMOS
Sensor Size	1/2.8 "
Effective Pixels	1944(H) X 1224(V) (2.38 MP)
Day / Night	Yes
Low Light Sensitivity	Superior
Minimum Illumination	Color: 0.003 lux at F2.0; B/W: 0.002 lux at F2.0
Color to B/W Switch	ISP based switch, configurable
Mechanical IR Cut Filter	Yes
IR Sensitivity Range	700-1100nm
IR LED	No
Electronic Shutter	1/5-1/2000 second (manual mode); 1/5-1/10000 second (auto mode)
Horizontal Resolution (TV Lines)	1100 TVL

S/N Ratio	75 dB
-----------	-------

Lens

Focal Length	Fixed focal, f2.93mm
Aperture	F2.0
Iris	Fixed iris
Focus	Manual focus
Lens Mount	CS Mount (interchangeable lens)
Horizontal Viewing Angle	101.3°
Vertical Viewing Angle	54.3°

PTZ

Pan, Tilt or Zoom protocol	Visca, Pelco-D, Pelco-P
----------------------------	-------------------------

Video

Compression	H.264 (Baseline/ Main/ High profile), MJPEG
Maximum Frame Rate vs. Resolution	60 fps at 1920 x 1080 60 fps at 1280 x 720 30 fps at 640 x 480 30 fps at 320 x 240
High Frame Mode	Support
Multi-Streaming	Simultaneous triple streams based on configurations of video resolution, compression format, and frame rate
Bit Rate	28Kbps - 6Mbps (per stream)
Bit Rate Mode	Constant, Variable
Wide Dynamic Range	Extreme WDR (145 dB)
Image Enhancement	White Balance, Brightness, Contrast, Sharpness, Automatic gain control, Flickerless, Digital Image Stabilizer (DIS, EIS), Defogging
Digital Noise Reduction	2D + 3D DNR
Privacy Mask	4 configurable regions
Text Overlay	Yes
Built-in Analytics	Basic Face Detection, Object Based Motion Detection, Tampering Detection, Object Line Crossing Detection, Object Enter Area Detection, Missing Object Detection, Unattended Object Detection, Object Loitering Detection
Server-based Analytics	Object Line Counting, People Counting, Face Detection, Object Based Motion Detection, Tamper, Object Line Crossing Detection, Object Enter Area Detection, Missing Object Detection, Unattended Object Detection, Smoke Detection, Heat Map, Dwell Time, People Queue Detection, (Require PC-based or standalone IVS or ALPR Server. Contact ACTi support for recommendations on how to maximize analytical accuracy)
Image Orientation	Rotation (Corridor mode)
IVS performance	Certain algorithms may require more computing power, which may limit the number of algorithms that can be concurrently used in the camera. Please test the actual performance before using in a project.

Audio

Audio Type	2-way, Line-in, Line-out
Audio Compression	8 kHz, 16 bit encoding, Mono, PCM, G.711

Network

Network Protocol & Service	TCP, UDP, HTTP, HTTPS, DHCP, PPPoE, RTP, RTSP, IPv6, DNS, DDNS, NTP, ICMP, ARP, IGMP, SMTP, FTP, UPnP, SNMP, Bonjour
Ethernet Port	1 x RJ-45 connector
Security	IP address filtering, HTTPS encryption, Password protected user level, Anonymous login, IEEE 802.1X network access control, Standard IoT Security (anti-hacking, anti-malware)

Video Analytics

Analysis Source Type	Video
Metadata Accuracy	Standard

Event

Event Trigger	Video motion detection (10 included and excluded polygonal regions), External device through digital input, Sound detection, Intelligent event detection, Video streams loss, System log buffer overrun, Remove system log, Logon events (Login Failure, Login Success, Block an Account)
Event Response	Notify control center, Change camera settings, Command other devices, E-mail notification with snapshots, Push notification to mobile device, Save video to local storage, Upload video to NVR server, Upload video or snapshot to FTP server, Activate external device through digital output

System

System Monitor	CPU loading, memory usage and network statistics via API
System Log	Support
Watchdog	Support

Integration

Unified Solution	Fully compatible with ACTi software
Software Development Kit	Yes
GPS Position	Manual setting
Edge Recording	Support (integration with NVR by ONVIF Profile G or proprietary protocol)**
ONVIF Compliant	Yes, Profile S, Profile G, Profile T, Profile Q, Profile M* (To be available through future firmware upgrade)
Web Browser	IE 11, Google Chrome, Microsoft Edge, Apple Safari
Auto Firmware Upgrade	Yes
SD Card Backup and Recovery	Automatically back up the video recordings from the memory card of camera to NVR 3 server with recovering lost videos after network connection recovery.

Interface

Serial Port	1, RS-485/RS-422, Terminal block
Audio Interface	Terminal block
Auto Iris Connector	External connector for DC iris lens
Local Storage	MicroSDHC, MicroSDXC Memory Card Slot (card not included, up to 256GB, Kingston or Sandisk only)
Digital Input/Output	1/1
Operating Button	Reset Button

General

Power Source	DC 12V, PoE Class 3 (IEEE802.3af)
Power Consumption	7 W (PoE)
Weight	425g (0.937lb)
Dimensions	(W x H x D): 67mm x 65mm x 142mm (2.6" x 2.6" x 5.6")
Environmental Casing	Optional housing (IP66)
Mount Type	Bracket, Pole Mount, Corner Mount
Starting Temperature	-10°C ~ 50°C (14°F ~ 122°F)
Operating Temperature	-10°C ~ 50°C (14°F ~ 122°F)
Operating Humidity	10% - 85% RH
Approvals	CE Class B, FCC Class B, EAC, UL (for optional PoE injector)
Real-time Clock (RTC)	Yes
Warranty	3 Year(s). For extended warranty offering, see http://www.acti.com/support/warranty

** Edge Recording function is integrated with NVR 3 Corporate / NVR 3 Business / INR / GNR series.

▶ Photo Indication

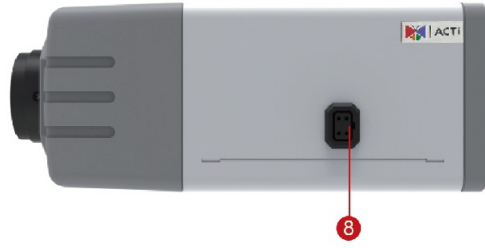
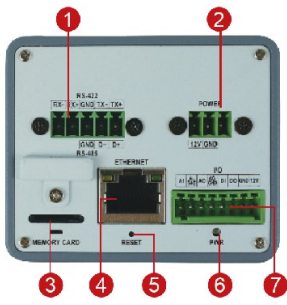

- 1 Serial Port
- 2 DC 12V Power Input
- 3 Memory Card Slot
- 4 Ethernet Port
- 5 Reset Button
- 6 Power LED
- 7 Audio Input / Output & Digital Input / Output
- 8 DC Iris Port



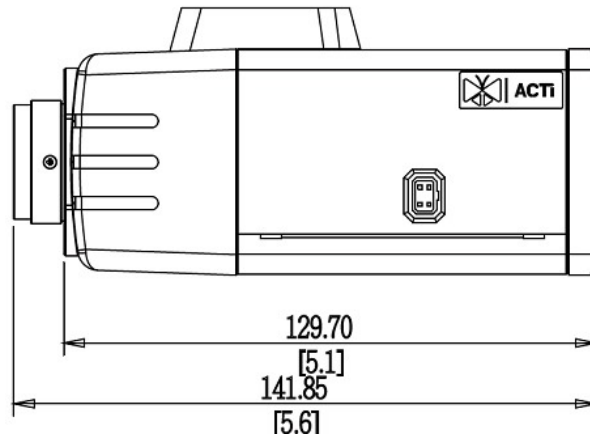
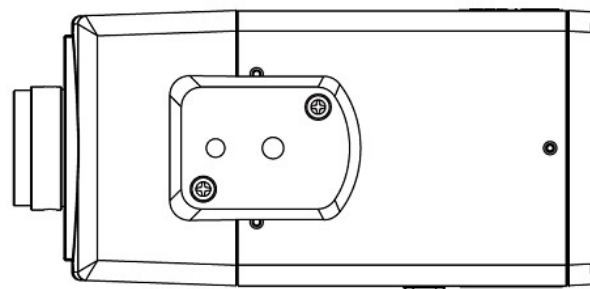
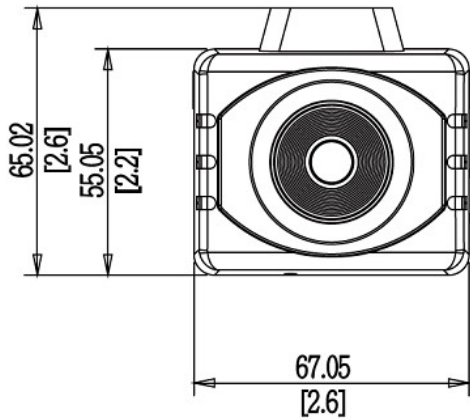





▶ Dimension Diagram



Unit: mm [inch]









► Related Products

Mounting Accessories - Camera Mount

PMAX-0402		Corner Mount
PMAX-0503		Pole Mount (for PMAX-0102, PMAX-0312, PMAX-0313, PMAX-0314, PMAX-0702, PMAX-1106, PMAX-1107), supports 5.25" to 8.5" Poles
PMAX-0508		Pole Mount (for PMAX-0203, PMAX-0204, PMAX-0205, PMAX-0206, PMAX-0704), supports 3" to 9" Poles
PMAX-0704		Junction Box (for A4x, B4x, B41x, E44, E45, E46, E48, E44A, E45A, E46A, E41x, I4x, PMAX-0203~PMAX-0205)
PMAX-1100		Bracket for Indoor Box Cameras
PMAX-1104		Bracket for Indoor Box Cameras (for A2x, D2x, E2x)
PMAX-1105		Bracket for Indoor Box Cameras (for B2x)
PMAX-1106		Bracket for Outdoor Box Cameras (KCM-5211E, KCM-5511, KCM-5611, Box Cameras with Outdoor Housing)

Note: Some mounting accessories may need additional accessories for installation. Please check www.acti.com/mountingselector for more information.

Enclosures - Box Camera Housing

PMAX-0200		Outdoor Housing with Heater and Fan (110V)
PMAX-0201		Outdoor Housing with Heater and Fan (220V)
PMAX-0202		Outdoor Housing
PMAX-0203		Heavy Duty Outdoor Housing with Heater and Fan (230V) and Bracket
PMAX-0204		Heavy Duty Outdoor Housing with Heater and Fan (110V) and Bracket
PMAX-0206		PoE Heavy Duty Outdoor Housing with Heater, Fan, Defogger and Bracket
PMAX-0208		Explosion Proof Housing with Heater, Fan (AC 110V~220V) and Bracket
PMAX-0210		Stainless Steel Housing with Heater, Fan (AC 110V~220V) and Bracket
PMAX-0221		POE Explosion-proof Stainless Steel SUS316 PTZ Housing, with Heater, Fan and IR

PMAx-0222



PoE Explosion-proof Stainless Steel SUS316 PTZ Housing, with Fan and Heater

PMAx-0228



PoE Explosion Proof Housing with Heater, Fan and Bracket

Lenses - Fixed Lens

PLEN-0130



Fixed Focal f2.93mm, Fixed Iris F2.0, Manual Focus, D/N, Megapixel, CS Mount Lens

Power Supply Accessories - Power Adapter

PPBX-0011



Power Adapter AC 100~240V, with universal connectors for all DC12V powered devices

Network & Storage Peripherals - Data Switch

PPSW-0102



PLANET FGSD-1011HP 8-Port 802.3at PoE Switch (PoE Budget 120W)

PPSW-0105



PLANET GS-4210-8P2C 8-Port Gigabit 802.3at Managed PoE Switch (PoE Budget 120W)

PPSW-1101



PLANET GS-4210-24PL4C 24-Port Gigabit 802.3at Managed PoE Switch (PoE Budget 440W)

PPSW-3100



PLANET FGSW-1816HPS 16-Port 802.3at PoE Switch (PoE Budget 220W)

Extenders - PoE Extender

PPEX-0100



Veracity OUTREACH Max Power over Ethernet (PoE) Extender

Extenders - PoE over Coaxial Extender Kit

PPOC-0100



Planet LRP-101C-KIT Power over Coax Adapter Kit

Audio Devices - Microphone

PMIC-0100



Active Microphone Omnidirectional for all Cameras with Line-in Audio

Illuminators - IR LED Illuminator

PLED-0200



SPINLUX (SL-A2IRXX10-24CL) IR Illuminator 10° Angle with 120 m approx. range

PLED-0201



SPINLUX (SL-A2IRXX25-24CL) IR Illuminator 25° Angle with 50 m approx. range

Other Accessories - Accessory Part

R707-10000



Mounting Block (for D2x, E2x, B2x, I2x)