

# E933M

2MP with D/N, Adaptive IR, Extreme WDR, SLLS,



- 2 Megapixel
- Day & Night with Superior Low Light Sensitivity and Adaptive IR LED
- Fixed Lens with f2.55mm/F2.2
- Extreme WDR
- Super wide angle
- Event trigger, response and notification

## ► Specifications

### Device

Product Type	Mini Dome
Maximum Resolution	2MP
Application Environment	Outdoor
Image Sensor	Progressive Scan CMOS
Sensor Size	1/2.8 "
Effective Pixels	1944(H) X 1224(V) (2.38 MP)
Day / Night	Yes
Low Light Sensitivity	Superior
Minimum Illumination	Color: 0.05 lux at F2.2, B/W: 0 lux at F2.2 (IR LED on)
Color to B/W Switch	ISP based switch, configurable
Mechanical IR Cut Filter	Yes
IR Sensitivity Range	700-1100nm
IR LED	Adaptive IR LED x 3 (850 nm)
IR Working Distance	15m
Electronic Shutter	1/5-1/2000 second (manual mode); 1/5-1/10000 second (auto mode)

Horizontal Resolution (TV Lines)	1100 TVL
S/N Ratio	75 dB

## Lens

Focal Length	Fixed focal, f2.55mm
Aperture	F2.2
Iris	Fixed iris
Focus	Fixed focus
Lens Mount	Board mount
Horizontal Viewing Angle	110.3°
Vertical Viewing Angle	62.7°
Viewing Angle Adjustment	Pan: ±90°, Tilt: 35°-90°, ( lens FOV from horizon up to 3.65°)

## Video

Compression	H.264 (Baseline/ Main/ High profile), MJPEG
Maximum Frame Rate vs. Resolution	60 fps at 1920 x 1080 60 fps at 1280 x 720 30 fps at 640 x 480 30 fps at 320 x 240
High Frame Mode	Support
Multi-Streaming	Simultaneous triple streams based on configurations of video resolution, compression format, and frame rate
Bit Rate	128Kbps - 12Mbps (per stream)
Bit Rate Mode	Constant, Variable
Wide Dynamic Range	Extreme WDR (145 dB)
Image Enhancement	White Balance, Brightness, Contrast, Sharpness, Automatic gain control, Flickerless, Digital Image Stabilizer (DIS, EIS), Defogging
Digital Noise Reduction	2D + 3D DNR
Privacy Mask	4 configurable regions
Text Overlay	Yes
On-Screen Graphics (Picture Overlay)	Yes
Built-in Analytics	Basic Face Detection, Object Based Motion Detection, Tampering Detection, Object Line Crossing Detection, Object Enter Area Detection, Missing Object Detection, Unattended Object Detection, Object Loitering Detection
Server-based Analytics	Object Line Counting, People Counting, Face Detection, Object Based Motion Detection, Tamper, Object Line Crossing Detection, Object Enter Area Detection, Missing Object Detection, Unattended Object Detection, Smoke Detection, Heat Map, Dwell Time, Direction Detection, Automatic License Plate Recognition, People Queue Detection, (Require PC-based or standalone IVS or ALPR Server. Contact ACTi support for recommendations on how to maximize analytical accuracy)
Image Orientation	Rotation (Corridor mode)
IVS performance	Certain algorithms may require more computing power, which may limit the number of algorithms that can be concurrently used in the camera. Please test the actual performance before using in a project.

**Audio**

Audio Type	1-way, Mic-in, Line-in
Audio Compression	8 kHz, 16 bit encoding, Mono, PCM, G.711

**Network**

Network Protocol & Service	IPv4/v6, TCP, UDP, DHCP, PPPoE, HTTP, HTTPS, DNS, DDNS, NTP, RTP, RTSP, RTCP, SMTP, FTP, IGMP, ICMP, ARP, Bonjour, UPnP, QoS, SNMP, IEEE 802.1X
Ethernet Port	1 x M12 pigtail connector (female, D-coding, 4-pin, PoE Type A)
Security	IP address filtering, HTTPS encryption, Password protected user level, Anonymous login, IEEE 802.1X network access control, Standard IoT Security (anti-hacking, anti-malware)

**Video Analytics**

Analysis Source Type	Video
Metadata Accuracy	Standard

**Event**

Event Trigger	Video motion detection (10 included and excluded polygonal regions), Sound detection, Intelligent event detection, Video streams loss, System log buffer overrun, Remove system log, Logon events (Login Failure, Login Success, Block an Account)
Event Response	Notify control center, Change camera settings, Command other devices, E-mail notification with snapshots, Push notification to mobile device, Upload video to NVR server, Upload video or snapshot to FTP server

**System**

System Monitor	CPU loading, memory usage and network statistics via API
System Log	Support
Watchdog	Support

**Integration**

Unified Solution	Fully compatible with ACTi software
Software Development Kit	Yes
GPS Position	Manual setting
Edge Recording	Support (integration with NVR by ONVIF Profile G or proprietary protocol)**
ONVIF Compliant	Yes, Profile S, Profile G, Profile T, Profile Q, Profile M* (To be available through future firmware upgrade)
GB28181 Compliant	Yes
Web Browser	IE 11, Google Chrome, Microsoft Edge, Apple Safari
Auto Firmware Upgrade	Yes

**Interface**

Audio Interface	Cable with 3.5mm Phone Jack
Local Storage	MicroSDHC, MicroSDXC Memory Card Slot (card not included, up to 256GB, Kingston or Sandisk only)
Operating Button	Reset Button

**General**

Power Source	PoE Class 2 (IEEE802.3af)
Power Consumption	5.04 W (PoE)
Weight	482g (1.063lb)
Dimensions	(Ø x H): 115mm x 70mm (4.5" x 2.8")
Environmental Casing	Weatherproof (IP68), Vandal proof (IK10), Vibration proof (EN50155)
Mount Type	Surface, Gang Box, Pendant, Converter for NPT Standard Mounts, Wall Mount, Pole Mount
Starting Temperature	-20°C ~ 50°C (-4°F ~ 122°F)
Operating Temperature	-20°C ~ 50°C (-4°F ~ 122°F)
Operating Humidity	10% - 85% RH
Approvals	CE Class B, FCC Class B, EAC, IP68, IK10, NEMA 4X, EN50155, UL (for optional PoE injector)
Real-time Clock (RTC)	Yes
Warranty	3 Year(s). For extended warranty offering, see <a href="http://www.acti.com/support/warranty">http://www.acti.com/support/warranty</a>

\*\* Edge Recording function is integrated with NVR 3 Corporate / NVR 3 Business / INR / GNR series.

### ► Photo Indication

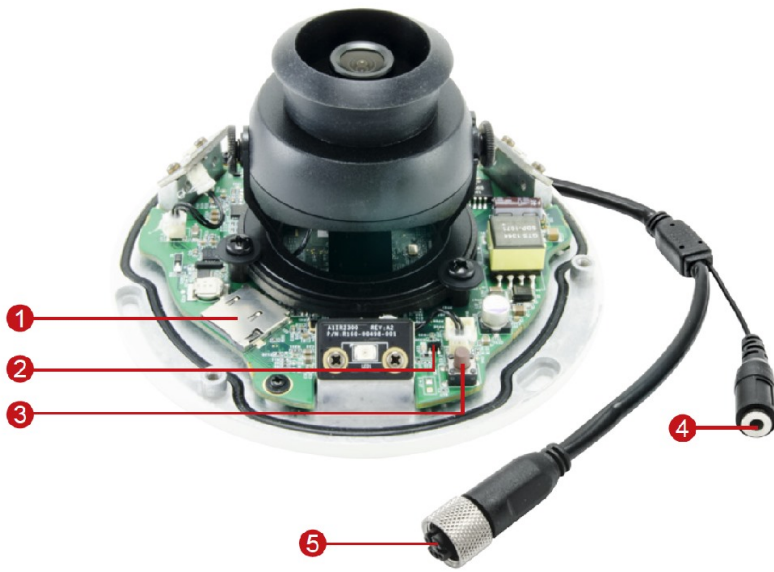

- 1 Memory Card Slot
- 2 Power LED
- 3 Reset Button
- 4 Audio Input



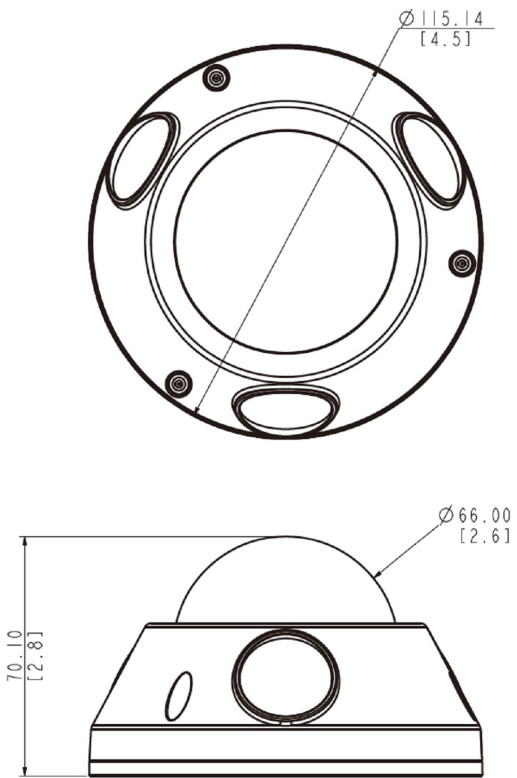





### ► Dimension Diagram



Unit: mm [inch]



## ► Related Products

### Mounting Accessories - Camera Mount

PMAX-0111		Straight Tube (for D5x, D9x, E5x, E9x, E9xx/M)
PMAX-0112		Extension Tube (for D5x, D9x, E5x, E9x, E9xx/M)
PMAX-0122		Straight Tube (for A71, A88, A9x,)
PMAX-0123		Extension Tube (for A71, A88, A9x,)
PMAX-0316		Wall Mount (for D5x, D9x, E5x, E78, E9x, E9xx/M)
PMAX-0506		Pole Mount (for A31, A4x, E78, E9x, E9xx), supports 2" to 3" Poles
PMAX-0805		Gang Box Converter (for D5x, D9x, E5x, E78, E9x, E9xx/M), supports 4" Round and 4" Octagon Boxes
PMAX-0809		Converter Ring, 1.0" NPT for Third-Party Mounting Accessories
PMAX-1400		Mount Kit (for D5x, D9x, E5x, E78, E9x, E9xx/M)

**Note:** Some mounting accessories may need additional accessories for installation. Please check [www.acti.com/mountingselector](http://www.acti.com/mountingselector) for more information.



### Dome Covers - Transparent Dome Cover

R701-50003		Dome Cover Housing with Transparent Dome Cover (for E924~E929(M), E933(M))
R701-50005		Transparent Dome Cover (for E924~E929(M), E933(M))

### Dome Covers - Smoked Dome Cover

PDCX-1112		Vandal Proof Smoked Dome Cover for E924(M)~E929(M), E933(M)
-----------	---	---

### Network & Storage Peripherals - Data Switch

PPSW-0102		PLANET FGSD-1011HP 8-Port 802.3at PoE Switch (PoE Budget 120W)
PPSW-0105		PLANET GS-4210-8P2C 8-Port Gigabit 802.3at Managed PoE Switch (PoE Budget 120W)
PPSW-1101		PLANET GS-4210-24PL4C 24-Port Gigabit 802.3at Managed PoE Switch (PoE Budget 440W)

PPSW-3100



PLANET FGSW-1816HPS 16-Port 802.3at PoE Switch (PoE Budget 220W)

### Extenders - PoE Extender

PPEX-0100



Veracity OUTREACH Max Power over Ethernet (PoE) Extender

### Extenders - PoE over Coaxial Extender Kit

PPOC-0100



Planet LRP-101C-KIT Power over Coax Adapter Kit

### Audio Devices - Microphone

PMIC-0100



Active Microphone Omnidirectional for all Cameras with Line-in Audio

PMIC-0200



Passive Microphone Omnidirectional for all Cameras with Mic-in Audio using 3.5mm Phone Jack

### Illuminators - IR LED Illuminator

PLED-0200



SPINLUX (SL-A2IRXX10-24CL) IR Illuminator 10° Angle with 120 m approx. range

PLED-0201



SPINLUX (SL-A2IRXX25-24CL) IR Illuminator 25° Angle with 50 m approx. range