

E936M

2MP with Extreme WDR, SLLS,



- 2 Megapixel
- Fixed Lens with f2.55mm/F2.2
- Extreme WDR
- Super wide angle
- Built-in Analytics
- Event trigger, response and notification

► Specifications

Device

Product Type	Mini Dome
Maximum Resolution	2MP
Application Environment	Outdoor
Image Sensor	Progressive Scan CMOS
Sensor Size	1/2.8 "
Effective Pixels	1944(H) X 1224(V) (2.38 MP)
Day / Night	Electronic Day / Night
Low Light Sensitivity	Superior
Minimum Illumination	Color: 0.1 lux at F2.2 (30 IRE , 2400 K); B/W: 0.1 lux at F2.2 (30 IRE, 2400 K)
Mechanical IR Cut Filter	No
IR LED	No
Electronic Shutter	1/5-1/32000 second (manual mode); 1/5-1/32000 second (auto mode)
Horizontal Resolution (TV Lines)	1100 TVL
S/N Ratio	56 dB

Lens	
Focal Length	Fixed focal, f2.55mm
Aperture	F2.2
Iris	Fixed iris
Focus	Fixed focus
Lens Mount	Board mount
Horizontal Viewing Angle	110.3°
Vertical Viewing Angle	62.7°
Viewing Angle Adjustment	Pan: ±90°, Tilt: 0°-90°

Video	
Compression	H.264 (Baseline/ Main/ High profile), MJPEG
Maximum Frame Rate vs. Resolution	60 fps at 1920 x 1080 60 fps at 1280 x 720 30 fps at 640 x 480 30 fps at 320 x 240
High Frame Mode	Support
Multi-Streaming	Simultaneous triple streams based on three configurations
Bit Rate	128Kbps - 12Mbps (per stream)
Bit Rate Mode	Constant, Variable
Wide Dynamic Range	Extreme WDR (145 dB)
Image Enhancement	White Balance, Brightness, Contrast, Sharpness, Automatic gain control, Flickerless, Digital Image Stabilizer (DIS, EIS), Defogging
Digital Noise Reduction	2D + 3D DNR
Privacy Mask	4 configurable regions
Text Overlay	Yes
On-Screen Graphics	Yes
Built-in Analytics	Basic Face Detection, Object Based Motion Detection, Tampering Detection, Object Line Crossing Detection, Object Enter Area Detection, Missing Object Detection, Unattended Object Detection, Object Loitering Detection
Server-based Analytics	Object Line Counting, People Counting, Face Detection, Object Based Motion Detection, Tamper, Object Line Crossing Detection, Object Enter Area Detection, Missing Object Detection, Unattended Object Detection, Smoke Detection, Heat Map, Dwell Time, Direction Detection, Automatic License Plate Recognition, People Queue Detection, (Require PC-based or standalone IVS or ALPR Server. Contact ACTi support for recommendations on how to maximize analytical accuracy)
Image Orientation	Flip, Mirror, Rotation (Corridor mode)
IVS performance	Certain algorithms may require more computing power, which may limit the number of algorithms that can be concurrently used in the camera. Please test the actual performance before using in a project.

Audio	
Audio Type	1-way, Mic-in, Line-in
Audio Compression	8 kHz, 16 bit encoding, Mono, PCM, G.711

Network

Network Protocol & Service	IPv4/v6, TCP, UDP, DHCP, PPPoE, HTTP, HTTPS, DNS, DDNS, NTP, RTP, RTSP, RTCP, SMTP, FTP, IGMP, ICMP, ARP, Bonjour, UPnP, QoS, SNMP, IEEE 802.1X
Ethernet Port	1 x M12 pigtail connector (female, D-coding, 4-pin, PoE Type A)
Security	IP address filtering, HTTPS encryption, Password protected user level, Anonymous login, IEEE 802.1X network access control

Video Analytics

Analysis Source Type	Video
Metadata Accuracy	Standard

Event

Event Trigger	Video motion detection (10 included and excluded polygons regions), Sound detection, Intelligent event detection
Event Response	Notify control center, Change camera settings, Command other devices, E-mail notification with snapshots, Push notification to mobile device, Upload video to NVR server, Upload video or snapshot to FTP server

Integration

Unified Solution	Fully compatible with ACTi software
Software Development Kit	Yes
GPS Position	Manual setting
ONVIF Compliant	Yes, Profile S, Profile G, Profile T, Profile Q
Web Browser	IE 11
Auto Firmware Upgrade	Yes

Interface

Audio Interface	Cable with 3.5mm Phone Jack
Local Storage	MicroSDHC, MicroSDXC Memory Card Slot (card not included, up to 256GB)
Operating Button	Reset Button

General

Power Source	PoE Class 2 (IEEE802.3af)
Power Consumption	3.92 W (PoE)
Weight	487g (1.07lb)
Dimensions	(Ø x H): 110mm x 60mm (4.3" x 2.4")
Environmental Casing	Weatherproof (IP68), Vandal proof (IK10), Vibration proof (EN50155)
Mount Type	Surface, Gang Box, Pendant, Converter for NPT Standard Mounts, Wall Mount, Pole Mount
Starting Temperature	-20°C ~ 50°C (-4°F ~ 122°F)
Operating Temperature	-20°C ~ 50°C (-4°F ~ 122°F)
Operating Humidity	10% - 85% RH
Approvals	CE Class B, FCC Class B, EAC, IP68, IK10, NEMA 4X, EN50121-3-2, EN50155, UL (for optional PoE injector)

Real-time Clock (RTC)	Yes
Warranty	3 Year(s). For extended warranty offering, see http://www.acti.com/support/warranty

► Photo Indication



- 1 Power LED
- 2 Audio Input
- 3 Ethernet Port
- 4 Reset Button
- 5 Memory Card Slot



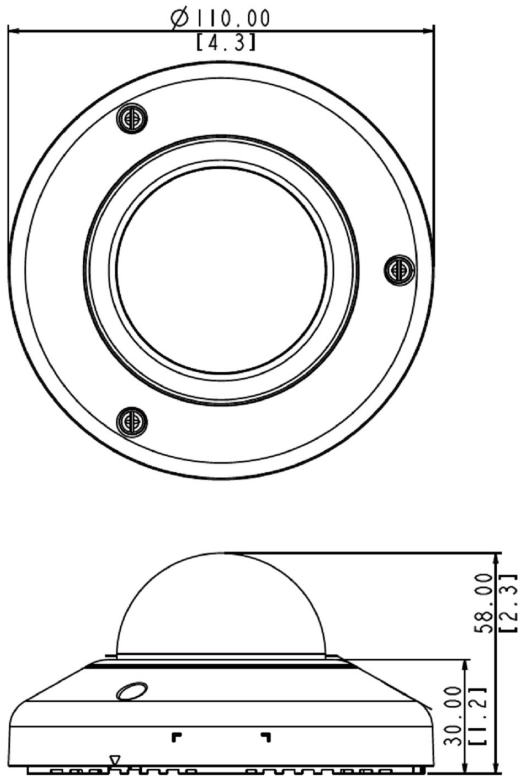





► Dimension Diagram



Unit: mm [inch]

▶ Related Products

Mounting Accessories - Camera Mount

PMAX-0111		Straight Tube (for D5x, D9x, E5x, E9x, E9xx/M)
PMAX-0112		Extension Tube (for D5x, D9x, E5x, E9x, E9xx/M)
PMAX-0122		Straight Tube (for A71, A88, A9x,)
PMAX-0123		Extension Tube (for A71, A88, A9x,)
PMAX-0316		Wall Mount (for D5x, D9x, E5x, E78, E9x, E9xx/M)
PMAX-0506		Pole Mount (for A31, A4x, E78, E9x, E9xx), supports 2" to 3" Poles
PMAX-0805		Gang Box Converter (for D5x, D9x, E5x, E78, E9x, E9xx/M), supports 4" Round and 4" Octagon Boxes
PMAX-0809		Converter Ring, 1.0" NPT for Third-Party Mounting Accessories
PMAX-1400		Mount Kit (for D5x, D9x, E5x, E78, E9x, E9xx/M)

Note: Some mounting accessories may need additional accessories for installation. Please check www.acti.com/mountingselector for more information.





Dome Covers - Transparent Dome Cover

R701-50004		Transparent Dome Cover (for E918~E923(M), E936(M), Q91)
------------	---	---

Dome Covers - Smoked Dome Cover

PDCX-1111		Vandal Proof Smoked Dome Cover for E918(M)~E923(M), E936(M)
-----------	---	---

Network & Storage Peripherals - Data Switch

PPSW-0100		PLANET FGSD-910HP 8-Port 802.3at PoE Switch (PoE Budget 120W)
PPSW-0102		PLANET FGSD-1011HP 8-Port 802.3at PoE Switch (PoE Budget 120W)
PPSW-0105		PLANET GS-4210-8P2C 8-Port Gigabit 802.3at Managed PoE Switch (PoE Budget 120W)
PPSW-1101		PLANET GS-4210-24PL4C 24-Port Gigabit 802.3at Managed PoE Switch (PoE Budget 440W)

PPSW-3100



PLANET FGSW-1816HPS 16-Port 802.3at PoE Switch (PoE Budget 220W)

Extenders - PoE Extender

PPEX-0100



Veracity OUTREACH Max Power over Ethernet (PoE) Extender

Extenders - PoE over Coaxial Extender Kit

PPOC-0100



Planet LRP-101C-KIT Power over Coax Adapter Kit

Audio Devices - Microphone

PMIC-0100



Active Microphone Omnidirectional for all Cameras with Line-in Audio

PMIC-0200



Passive Microphone Omnidirectional for all Cameras with Mic-in Audio using 3.5mm Phone Jack

Installation Support - Camera Installation Kit

PMON-2000



Camera Installation Kit