

ECT-D32V2 2 MP EXIR VF Dome Camera



- 1080p vari-focal bullet camera
- EXIR 2.0: advanced infrared technology with 40 m IR distance
- Water and dust resistant (IP66)
- 4 in 1 (4 signals switchable TVI/AHD/CVI/CVBS).



▪ Specification

Selection Parameter	
Resolution	2MP
Case Type	Dome
Length Type	Varifocal Lens
IR Distance	30~60m
WDR	DWDR
Star Light	N/A
Power Supply	DC12V
Protection Level	IP66
Video Output	4 in 1
Camera	
Lens	2.8 mm to 12 mm
Horizontal Field of View	111.5° to 33.4°
Lens Mount	Φ14
Day & Night	IR cut filter
Synchronization	Internal synchronization
Angle Adjustment	Pan: 0° to 355°, Tilt: 0° to 75°, Rotation: 0° to 355°
Image Sensor	2 MP CMOS image sensor
Signal System	PAL/NTSC
Frame Rate	PAL:1080p@25fps,NTSC: 1080p@30fps
Resolution	1920 (H) × 1080 (V)
Min. illumination	0.01 Lux@(F1.2, AGC ON), 0 Lux with IR
Shutter Time	1/25 (1/30) s to 1/50,000 s
Menu	
AGC	High/Medium/Low/Off
Day/Night Mode	Auto/Color/BW (Black and White)
Backlight Compensation	Support
DWDR (Digital Wide Dynamic Range)	Support
Language	English
Functions	Brightness, Sharpness, DNR, Mirror, Smart IR
Interface	
Video Output	1 HD analog output
Switch Button	TVI/AHD/CVI/CVBS
General	
Operating Condition	-40 °C to 60 °C (-40 °F to 140 °F), Humidity: 90% or less (non-condensation)
Power Supply	12 VDC ± 15%
Power Consumption	Max. 4.2 W
Material	Metal
IR Range	Up to 40 m
Dimensions	∅ 143 mm × 106.7 mm (∅ 5.62" × 4.19")
Weight	630 g (1.39 lb.)
Ingress Protection	IP66,IK10

▪ **Available Model**



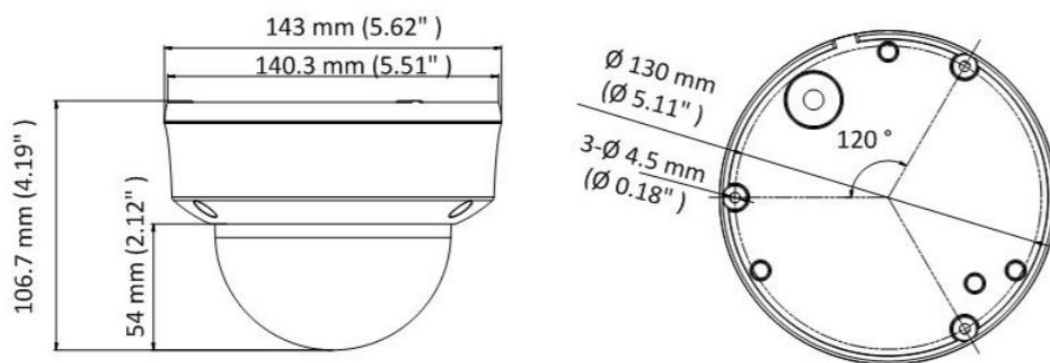

ECT-D32V2(2.8-12mm)(美国子公司),

▪ **Dimension**



▪ **Accessory**

▪ **Optional**

WML	CB140-DM45	CM	PC140-DM45	CPM
				
PM	SRSL			

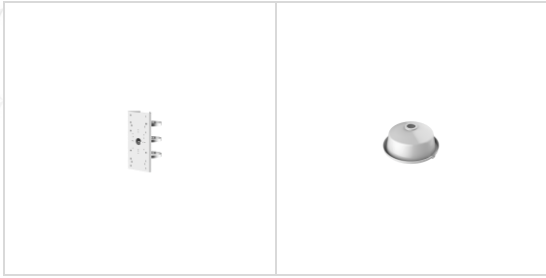

Distributed by

**HIKVISION®****Headquarters**

No.555 Qianmo Road, Binjiang District,
Hangzhou 310051, China
T +86-571-8807-5998
overseasbusiness@hikvision.com

Hikvision USA
T +1-909-895-0400
sales.usa@hikvision.com

Hikvision Australia
T +61-2-8599-4233
salesau@hikvision.com

Hikvision India
T +91-22-28469900
sales@pramahikvision.com

Hikvision Canada
T +1-866-200-6690
sales.canada@hikvision.com

Hikvision Thailand
T +662-275-9949
sales.thailand@hikvision.com

Hikvision Europe
T +31-23-5542770
sales.eu@hikvision.com

Hikvision Italy
T +39-0438-6902
info.it@hikvision.com

Hikvision Brazil
T +55 11 3318-0050
Latam.support@hikvision.com

Hikvision Turkey
T +90 (216)521 7070- 7074
sales.tr@hikvision.com

Hikvision Malaysia
T +601-7652-2413
sales.my@hikvision.com

Hikvision UK & Ireland
T +01628-902140
sales.uk@hikvision.com

Hikvision South Africa
Tel: +27 (10) 0351172
sale.africa@hikvision.com

Hikvision France
T +33(0)1-85-330-450
info.fr@hikvision.com

Hikvision Kazakhstan
T +7-727-9730667
nikia.panfilov@hikvision.ru

Hikvision Vietnam
T +84-974270888
sales.vt@hikvision.com

Hikvision UAE
T +971-4-4432090
salesme@hikvision.com

Hikvision Singapore
T +65-6684-4718
sg@hikvision.com

Hikvision Spain
T +34-91-737-16-55
info.es@hikvision.com

Hikvision Tashkent
T +99-87-1238-9438
uzb@hikvision.ru

Hikvision Hong Kong
T +852-2151-1761
info.hk@hikvision.com

Hikvision Russia
T +7-495-669-67-99
saleru@hikvision.com

Hikvision Korea
T +82-(0)31-731-8817
sales.korea@hikvision.com

Hikvision Poland
T +48-22-460-01-50
info.pl@hikvision.com

Hikvision Indonesia
T +62-21-2933759
Sales.Indonesia@hikvision.com

Hikvision Colombia
sales.colombia@hikvision.com