

**1080p SIP Vandalproof Door Phone with  
RFID and PoE**

**HDP-1261PT**

**Quick Installation Guide**

# Table of Contents

1. Package Contents.....	3
2. Physical Specifications .....	4
2.1 Wall-mounted Kit.....	4
3. Product Appearance Descriptions .....	5
3.1 Panel.....	5
3.2 Interface.....	5
3.3 Wiring Instructions: .....	6
4. Wall-mount Installation .....	7
5. Searching Door Phone .....	11
6. Starting Web Management and Door Phone Setting.....	12
7. Door Unlocking Setting .....	14
8. Customer Support .....	16

# 1. Package Contents

Thank you for purchasing PLANET SIP Vandalproof Door Phone, HDP-1261PT.

Open the box of the SIP Vandalproof Door Phone and carefully unpack it. The box should contain the following items:

<p>SIP Vandalproof Door Phone x 1</p>	<p>Quick Installation Guide QR Code Sheet x 1</p>	
		
<p>Mounting Template x 1</p>	<p>Wall-mounted Kit x 1</p>	<p>RFID Card x 2</p>
		
<p>Screw Driver x 1</p>	<p>Pin Cable x 1</p>	<p>Screw Kit x 1</p>
		

If any item is found missing or damaged, please contact your local reseller for replacement.

## 2. Physical Specifications

Model	Dimensions
HDP-1261PT	88 x 36.15 x 177.4 mm

### 2.1 Wall-mounted Kit

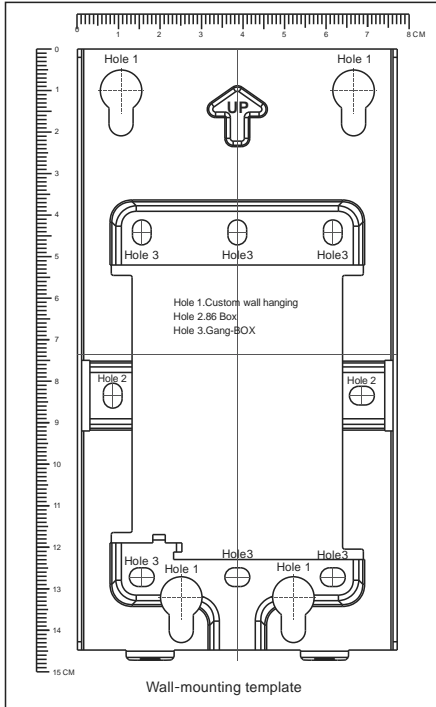

### 3. Product Appearance Descriptions

#### 3.1 Panel

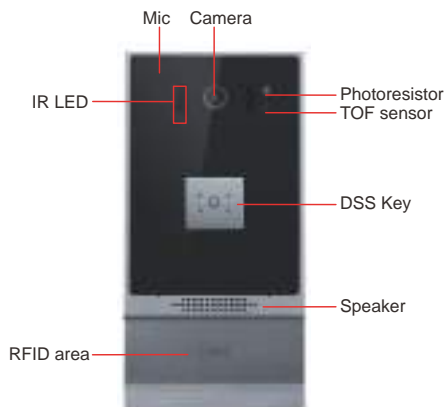

#### 3.2 Interface

Open the rear case of the device where there is a row of terminal blocks for connecting power supply, electric lock control, etc. The connection is as follows:

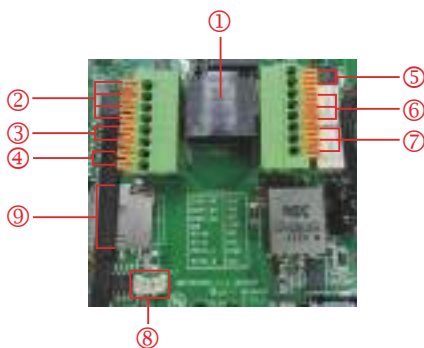

Serial number	Description
1	Ethernet interface: standard RJ45 interface, 10/100M adaptive (It is recommended to use CAT5 or CAT5E network cable.).
2	3 short-circuit input detection interfaces for connecting switches, infrared probes, door magnets, vibration sensors and other input devices.
3	Wiegand interface
4	RS485 interface (Reserved for future use)
5	Power interface: 12V/1A input up positive, down grounded
6, 7	2 short-circuit output control interfaces for controlling electric locks, alarms, etc.
8	Line out interface
9	SD card slot

### 3.3 Wiring Instructions:

NO: Normally Open Contact;

COM: Common Contact;

NC:Normally Close Contact.

Driving mode	Electric-lock Mode		Connections
	No electricity when open	Electrify when open	
Passive			
√	√	√	<p>Door Phone Power Input</p> <p>Power Supply 12V/2A</p> <p>Indoor switch</p> <p>Electric lock (normally open type) No electricity when open the door</p>
√		√	<p>Door Phone Power Input</p> <p>Power Supply 12V/2A</p> <p>Indoor switch</p> <p>Electric lock (normally closed type) when the power to open the door</p>
√	√		<p>External Power Supply 12V/1A</p> <p>Door Phone Power Input</p> <p>Power Supply 12V/2A</p> <p>Indoor switch</p> <p>Electric lock (normally open) Without the power to open the door</p>

## 4. Wall-mount Installation

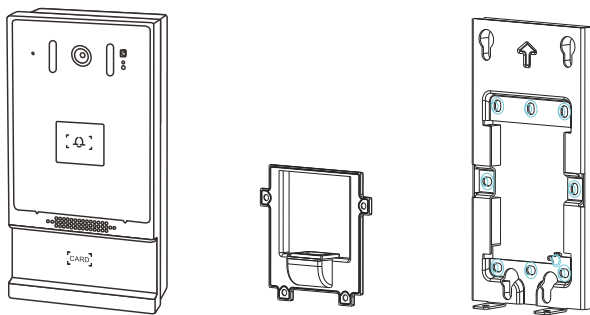

**Figure 4-1:** Three Major Parts of HDP-1261PT  
(Main Body, Back Shell and Wall Bracket)

### **Step 1:** Installation preparation

#### A. Check the following contents:

- $\phi 5.2 * \phi 3 * 6$ mm screws x 3
- TA4\*30mm screws x 5
- $\phi 6 * 30$ mm screw anchors x 5
- PM4\*16mm screw x 3
- TM6\*20mm screw x 5
- Screw Driver x 1
- Pin Cable x 1

#### B. Tools that may be required:

- Phillips screwdriver, hammer, RJ45 crimper
- Electric impact drill with an 8mm drill bit

**Step 2:** Drilling

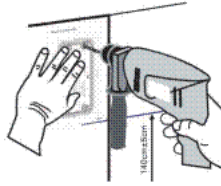
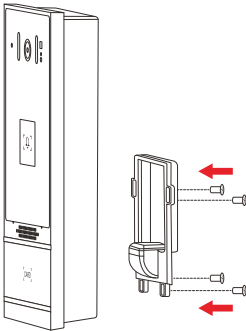

**Figure 4-2:** Wall Mounting

- A. Place the mounting template with dimensions on the surface of a wall in a desired flat position.
- B. Use an electric drill to drill the 4 holes marked on the mounting template. It is recommended to drill about 50mm deep. Remove the template when finishing drilling.
- C. Push or hammer wall anchors into the drilled holes.

**Step 3:** Removing hanging bracket and back panel

- A. Detach the wall bracket downward from the device and loosen the four screws on the rear cover with a screwdriver, as shown in Figures 4-3-a and 4-3-b.



**Figure 4-3-a:**



**Figure 4-3-b:**

**Step 4:** Install the wall bracket, wiring and casing

- A. Align the screw holes of the wall bracket with the holes in the wall and fix them to the wall with the screws, as shown in Figure 4-4.
- B. Pass all the wires through the silicone plug in the middle of the bottom case.

The length of all the lines should be 15 to 20 cm, as shown in Figure 4-5.



**Note**

The outlet hole of the bottom case faces down.

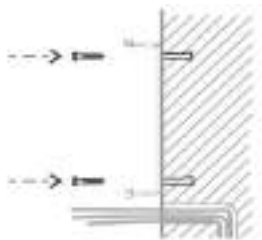

**Figure 4-4:**

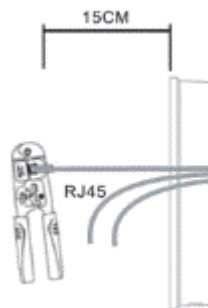

**Figure 4-5:**

- C. Connect the cables of RJ45, power, and electric-lock to the motherboard socket as mentioned in connector description.
- D. Connect the terminal of the wired cable to the motherboard socket.
- E. Test whether there is electricity by doing the following: Press the DSS key button for 3 seconds to get the IP address of intercom by voice. Input access password or press the indoor switch to check electric-lock installation.



**Note**

Do not proceed mounting until you have finished the electric checking.

F. Attach the device to the wall bracket in a top-down manner, locking the screws at the Bottom, as shown in Figure 4-6.

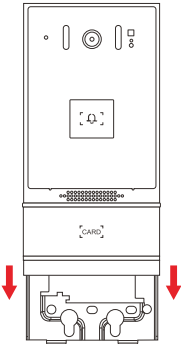

**Figure 4-6:**

## 5. Searching Door Phone

There are two methods as shown below to search the HDP-1261PT.

### Method 1:

Open the **Planet SmartDiscoveryLite Utility**. Press the Refresh button to search the HDP-1261PT and find the IP address.



### Method 2:

Long-press **DSS key** for **3 seconds** after powering on for 30 seconds, and when the speaker beeps rapidly, press the **speed-dial button** within **5 seconds**, and the system will automatically announce the IP address by voice.

In addition, device provides the device surface DSS key operation to switch IP address acquisition mode:

Touch and hold the **speed-dial button** for **3 seconds**, wait for the speaker to beep, press the **speed-dial button three times** within **5 seconds**, and the system will automatically announce the IP address by voice after successfully switching to the network mode.

### Restore to Default

When the HDP-1261PT is powered on and the DSS button indicator is rapidly flashing, press the DSS button once to enter POST mode. Then press the speed-dial button three times, the system will reset to default and automatically announce the IP address by voice after successfully switching to the network mode.

## 6. Starting Web Management and Door Phone Setting

**Step 1:** Log in the web setting page of door phone

Enter the IP address of the door phone (e.g., <https://172.16.0.1>) in the address bar using the **https** method of your PC's web browser.

The default user name and password are **admin** and **123**, respectively



**Step 2:** Add the SIP account.

Set SIP server address, port, user name, password and SIP user with assigned SIP account parameters.

Select "Activate", and then click Apply to save this setting.





## 7. Door Unlocking Setting

### RFID Card

- Step 1:** Access control settings on web page →EGS Setting →Add Card Rule → Select “Type” (“Normal” card provides door opening function, “Add” card and “Del” card provides add and delete card function, Default “Normal” card)
- Step 2:** Enter your name and card number (just enter the first 10 digits of the card number), and click “Add” to add the card to the list.
- Step 3:** Access the card reading area of the device through the configured ID card  to open the door.



## Remote Password

**Step 1:** Set access control on the web page → EGS Setting → Password → Add password rule → Select "Remote"

**Step 2:** Enter the Name, Password and Number. Press Add to Password Table.

**Step 3:** The owner answers the access control call and presses " \* " (default password) or "123456" (new password) to open the door for visitors.



---

## 8. Customer Support

Thank you for purchasing PLANET products. You can browse our online FAQs resource and User's Manual on PLANET Web site first to check if it could solve your issue. If you need more support information, please contact PLANET VoIP support team.

PLANET online FAQs:

<http://www.planet.com.tw/en/support/faq>

PLANET VoIP team mail address:

[support\\_voip@planet.com.tw](mailto:support_voip@planet.com.tw)

HDP-1261PT User's Manual:

<https://www.planet.com.tw/en/support/downloads?&method=keyword&keyword=HDP-1261PT&view=3#list>



Copyright © PLANET Technology Corp. 2023.

Contents are subject to revision without prior notice.

PLANET is a registered trademark of PLANET Technology Corp.

All other trademarks belong to their respective owners.