

# ENR-130

## 16-Channel Desktop Standalone NVR



- 2-bay Desktop Standalone NVR
- Maximum Number of Video Devices: 16
- Free License: 16
- Event trigger, response and notification
- Workstation, Web Client, Mobile Client
- Video export formats: AVI, RAW

### ► Solution Diagram

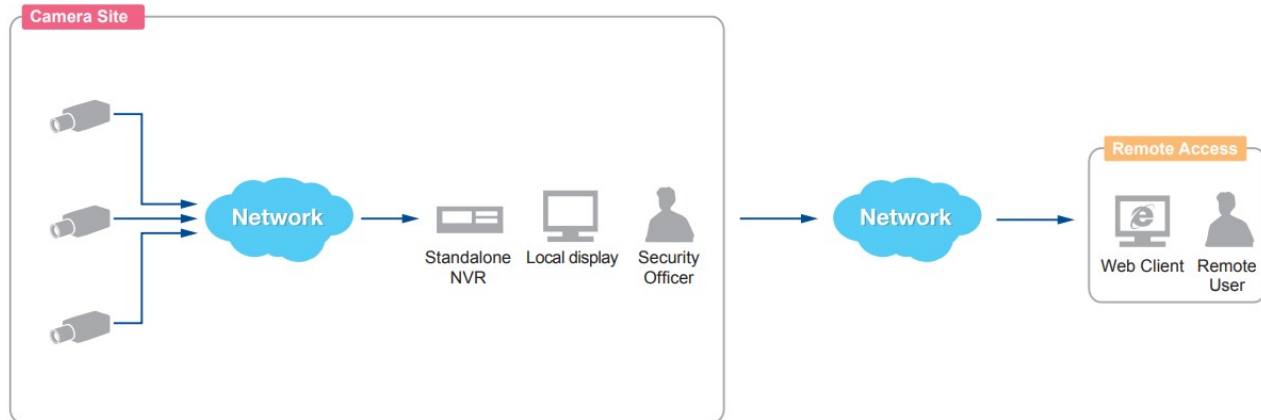

Remote User: Administrator / Supervisor / Manager / Security Officer

### ► Specifications

#### Device

Product Type	Standalone NVR
Maximum Resolution	Local: up to 4MP (2048x2048); Remote: up to 12MP
Maximum Number of Cameras	16

Maximum Number of Video Devices	16
Maximum Number of Clients	Local: 1, Remote: 2

### License

License required	No
Free License	16

### Live View

Display Layout Mode	Local:1,2,4,9,12,16,1+5,1+7,1+12,2+4,2+8 Remote:1,2,4,9,12,16,1+5,1+7,1+12,2+4,2+8
Fisheye Dewarping	Local: No, Remote: Yes
Local Live View performance	Please check "Standalone NVR Performance Validator" ( <a href="http://www.acti.com/SANVRPerformance">http://www.acti.com/SANVRPerformance</a> )
Digital Zoom	Yes
Event Status	Display event status upon alarm or upon connection loss or recovery between server and client
Instant Playback	Instant Playback in live view window (Remote client)

### PTZ

PTZ Control	PTZ Control, Speed Control, 32 preset points
Joystick	USB based joystick supported

### Video

Compression	H.264
-------------	-------

### Audio

Audio Compression	PCM, G.711
-------------------	------------

### Network

Network Protocol & Service	IPv4/v6, TCP, IP, UDP, HTTP, HTTPS, DHCP (Server/Client), PPPoE, RTP, RTSP, DNS, DDNS, NTP, SNTP, ICMP, ARP, SMTP, UPnP, To be available through future firmware upgrade
Ethernet Port	Total ports: 2 port(s) (LAN 1) Non-PoE: 1 port(s), Ethernet (1000 Base-T), RJ-45 connector (LAN 2) Non-PoE: 1 port(s), Ethernet (10/100 Base-T), RJ-45 connector
Security	HTTPS encryption, Password protected user level

### Recording

Recording Resolution	12MP, 10MP, 8MP, 6MP, 5MP, 4MP, 3MP, 2MP, 1080p (1920x1080), 720p, CIF, VGA
Scheduled Recording	Yes
Event Recording	Yes
Manual Recording	Yes
Event Speed-up Recording	Yes
Dual Stream Management	Yes
Recording Capability	≥25 fps at 1920x1080 (per channel)
Maximum Recording Throughput	48 Mbps

**Search & Playback**

Playback Control	Continuous forward and backward playback with speeds 0.5x/1x/2x/4x/8x/16x/32x, pause, stop
Synchronized Playback	16 channels
Video Export	AVI, RAW

**Event**

Event Trigger	Video motion detection, External device through digital input, Network loss and recovery
Event Response	Play alert sound, E-mail notification with snapshots, Go to PTZ preset point or preset tour, Activate external device through digital output

**System**

Permission control	Unlimited number of users, Customizable permissions for user groups
Client PC Operating System	Windows 7 SP1, Windows 8.1
Server Operating System	Embedded Linux
Mobile Client Program	Mobile device application (ACTi Mobile Client) supports Live View, PTZ Control, Event/time based search and playback, iPad, Android device
USB	2-Port USB 2.0
Language	Multi-Language
System Status Monitor	Real time status reports on remote browser

**Integration**

Unified Solution	Fully compatible with ACTi cameras, encoders, central management system, TV wall and intelligent video surveillance software
ONVIF Compliant	Yes, Profile S
Web Browser	IE 11 (Please verify that your computer meets the minimum system requirements for Internet Explorer from Microsoft website.)

**Storage**

Storage Bay	SATA, Max. 2 Disk(s) (without storage disks)
HDD Size	3.5"
Maximum Recording Capacity	14TB x2

**Interface**

Local Access	USB keyboard & mouse, USB Joystick
Local Display Interface	HDMI x 1,

**General**

Power Source	DC 12V
Weight	1390g (3.064lb)
Dimensions	(W x H x D): 135mm x 121mm x 251mm (5.3" x 4.8" x 9.9")
Bundled Accessories	Power Adapter
Fan	Yes
Operating Temperature	0°C ~ 40°C (32°F ~ 104°F)

Operating Humidity	10% - 85% RH
Remote Access	Workstation, Web Client, Mobile Client
Approvals	CE, FCC, UL (for bundled power adapter)
Warranty	3 Year(s). For extended warranty offering, see <a href="http://www.acti.com/support/warranty">http://www.acti.com/support/warranty</a>

### ► Photo Indication

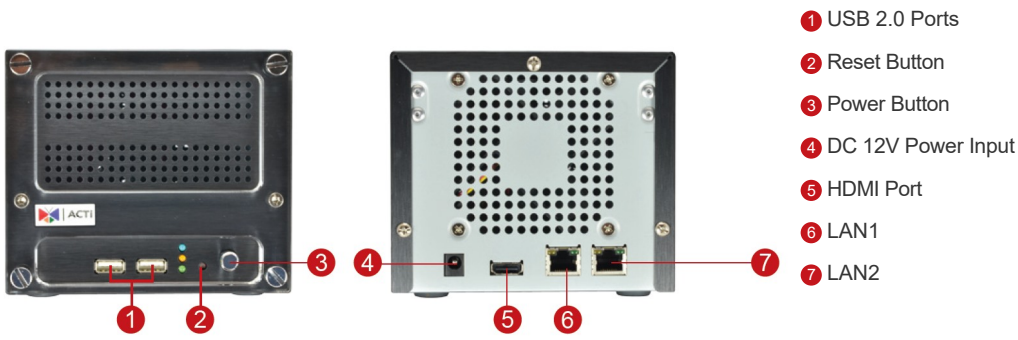

### ► Dimension Diagram

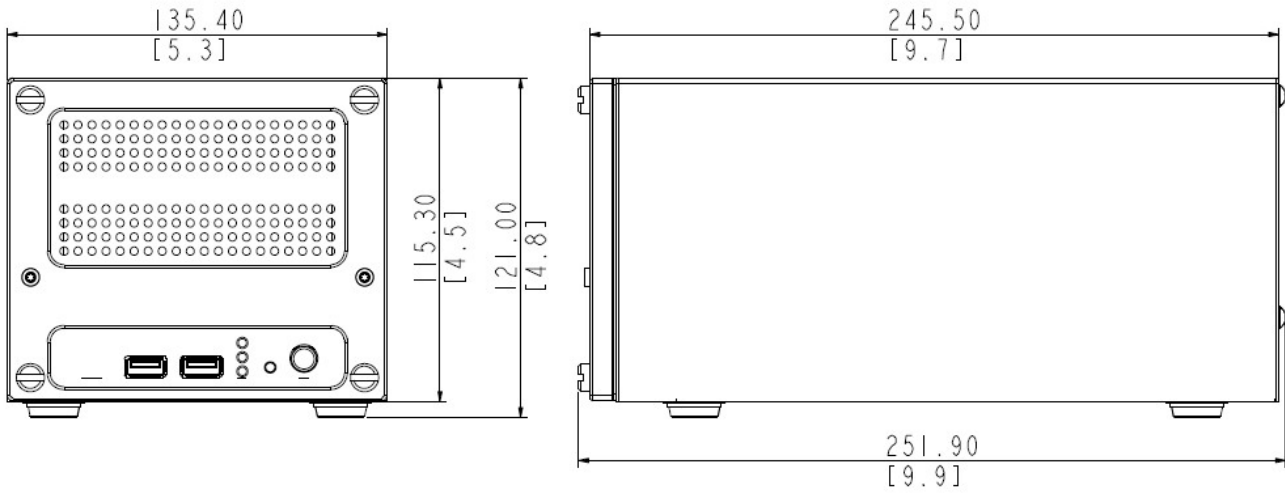

Unit: mm [inch]

## ▶ Related Products

### Power Supply Accessories - Power Adapter

R707-X0003  Power Adapter AC 100~240V with universal connectors (for ENR-110, ENR-120, ENR-130)

### Network & Storage Peripherals - Hard Disk

PHDD-2200  WD WD1005FBYZ 1TB 3.5" Hard Disk Drive, 7200 RPM 128 MB Cache (for ENR-0x0P, ENR-110, ENR-120, ENR-130, ENR-22x, ENR-22xP, GNR-310, GNR-320, INR-100, INR-340, INR-430, INR-440, INR-450, INR-460)

PHDD-2301  HGST ULTRASTAR 7K6000 2TB 3.5" Hard Disk Drive, 7200 RPM 128MB Cache (for ENR-1xx, ENR- 0x0P, ENR-22x, ENR-22xP)

PHDD-2501  HGST ULTRASTAR 7K6000 4TB 3.5" Hard Disk Drive, 7200 RPM 128MB Cache (for ENR-1xx, ENR-0x0P, ENR-22x, ENR-22xP)

PHDD-2702  WD Ultrastar 6TB 3.5" Hard Disk Drive, 7200 RPM 256MB Cache

PHDD-2900  WD WD8002FRYZ 8 TB 3.5" Hard Disk Drive, 7200 RPM 128 MB Cache (for GNR-310, GNR-320, INR-100, INR-340, INR-410, INR-430, INR-440, INR-450, INR-460)

PHDD-2A00  WD WD101KRYZ 10TB 3.5" Hard Disk Drive, 7200 RPM 256MB Cache (for ENR-xxx, ENR-xxxP, GNR-330, GNR-410, INR-100, INR-340, INR-410, INR-430, INR-440, INR-450, INR-460, INR-470)

PHDD-2B01  HGST ULTRASTAR 7K6000 12TB 3.5" Hard Disk Drive, 7200 RPM 256MB Cache

PHDD-2E01  HGST ULTRASTAR 7K6000 14TB 3.5" Hard Disk Drive, 7200 RPM 512MB Cache

### Controllers - Joystick

PJSK-0100  Apem 100-550-BLK-RF Joystick for PTZ Control (for all ENR, INR, and MNR Series)