

# GV-IO Box 16 Ports / GV-IO Box 16E

## Contents

1.	Key Features .....	2
2.	Models .....	2
3.	Compatible Software .....	2
4.	Packing List.....	3
5.	Overview .....	3
6.	DIP Switch.....	4
7.	Connections to PC .....	5
7.1	Installing USB Driver .....	6
7.2	Assigning Addresses to GV-IO Box .....	7
7.3	Extending Transmission over the Distance .....	8
8.	Accessing GV-IO Box 16 Ports over Networks .....	10
8.1	Fixed IP Connection .....	11
8.2	DHCP Connection .....	12
8.3	Configuring GV-IO Box on Internet .....	14
8.4	Enabling the Cloud Service .....	15
8.5	Other Setting .....	16
8.6	Input Setting .....	17
8.7	Output Setting .....	18
8.8	In/Out Monitor.....	19
9.	Updating Firmware .....	20
10.	Changing Login ID and Password .....	21
11.	Viewing System Log Information .....	21
12.	Specifications .....	21

# GV-IO Box 16 Ports / GV-IO Box 16E

The GV-IO Box 16 series provides 16 inputs and 16 relay outputs, and supports both DC and AC output voltages.

## 1. Key Features

- 16 inputs and 16 outputs are provided.
- Up to 9 pieces of GV-IO Box 4 / 8 / 16 ports can be chained together.
- A USB port is provided for PC connection (max. 30V DC, 3A output).
- Up to 16 connections from GeoVision software are allowed to control one GV-IO Box (GV-IO Box 16E required).
- Supports GV-IoT mobile app for remote management (GV-IO Box 16E of firmware V2.00 or later required)

## 2. Models

The GV-IO Box 16 series includes two models:

- **GV-IO Box 16 Ports**
- **GV-IO Box 16E** (which includes an Ethernet module with network connectivity)

## 3. Compatible Software

- GV-DVR / NVR / VMS
- GV-ASManager
- GV-Control Center
- GV-Center V2

**Note:** GV-ASManager and GV-Control Center only accept network connection from GV-IO Box.

## 4. Packing List

1. GV-IO Box
2. USB Cable (Type A to B, only for GV-IO Box 16 Ports)
3. Power Adapter DC 12V
4. Download Guide

## 5. Overview

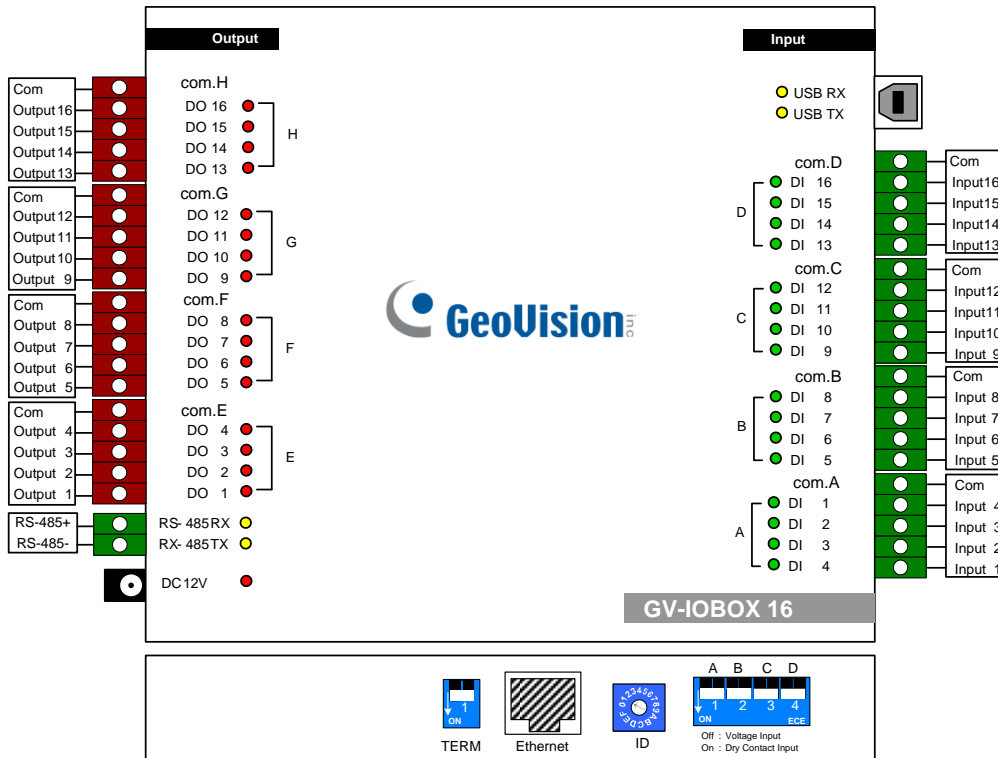

## 6. DIP Switch

The GV-IO Box allows the mix of dry and wet contact devices together. The 16 inputs are divided into four-in-one groups (A, B, C and D) and are related to the 4 switches on the box for dry and wet contact.

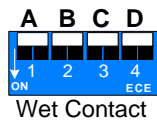

To change the inputs to wet contact, push the switch upward.

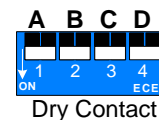

To change the inputs to dry contact, push the switch downward.

### Note:

1. The RS-485 connectors do not support the conversion function from RS-485 to RS-232. Do not connect RS-485 devices, such as PTZ camera, to the connectors.
2. To add a **GV-IO Box 16 Ports** to GV-DVR/NVR version 8.2 or later, select **GVIO-USB (16)** from the Device drop-down list in the System Configure dialog box.

## 7. Connections to PC

There are three ways to connect GV-IO Box to a PC. Only one of the three methods can be applied at a time.

- (1) **USB cable:** Use the USB cable to connect a PC.
- (1) **RS-485 wiring:** Through the option of GV-Hub, GV-COM, GV-NET Card or GV-NET/IO Card, use the RS-485 connectors to connect to a PC. RS-485 connection is suitable for longer distance wiring of up to 600 m / 1968.5 ft.
- (2) **Network:** **GV-IO Box 16E** is required. See 7. *Accessing GV-IO Box 16 Ports over Networks*.

1. Use the USB cable to connect GV-IO Box to a PC. **(Allowed for DC Output Voltage only)**

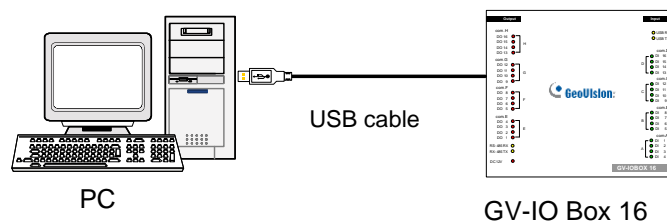

**Note:** It is required to install the USB driver. See 6.1 *Installing USB Drive*.

2. Use the RS-485 connectors to connect GV-IO Box to a PC. **(Allowed for AC/DC Output Voltage)**

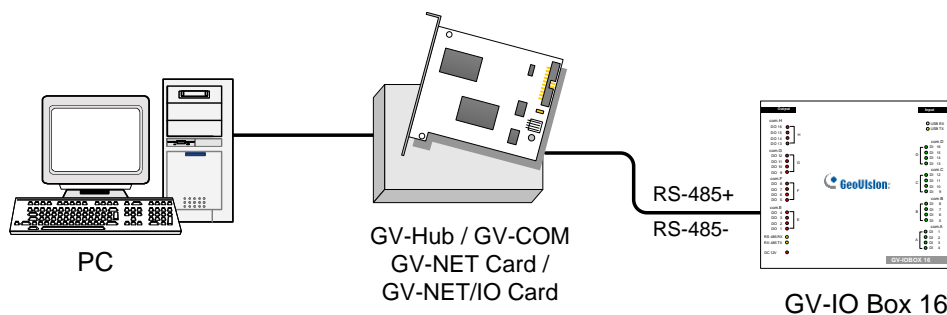

## 7.1 Installing USB Driver

To use the USB function, it is required to install the driver on the PC. Follow these steps to install the driver:

1. Download and install the USB Driver from the [website](#).

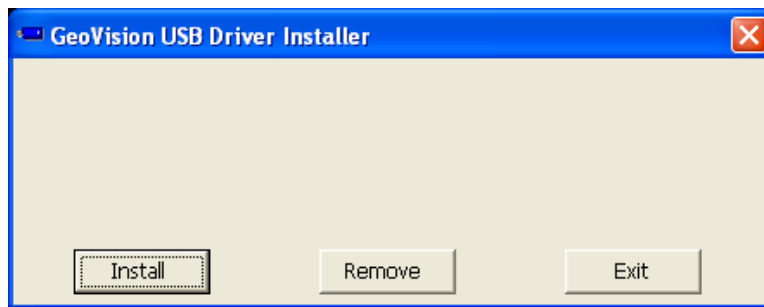

2. Click **Install** to install the drivers. When the installation is complete, this message will appear: *Install Successfully*.
3. Click **Exit** to close the dialog box and restart the PC.

To verify the drivers are installed correctly, go to Windows **Device Manager** after restarting the PC. Expanding the **Ports** field, you should see **XR21B1411 USB UART**. The COM number in the parenthesis indicates the COM port currently in use.

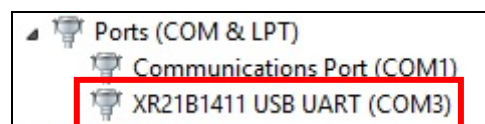

**Note:** If you unplug the GV-IO Box 16 Ports from the PC and connect another GV-IO Box to the same USB port, the COM port may be changed. Access the Windows **Device Manager** again to look up the new COM port number.

## 7.2 Assigning Addresses to GV-IO Box

You can connect any type of GV-IO Box model together through RS-485 wiring. Up to 9 pieces of GV-IO Box can be chained together to expand the IO capacity. Use the ID switch (1~9) to assign addresses 1~9 to each GV-IO Box.

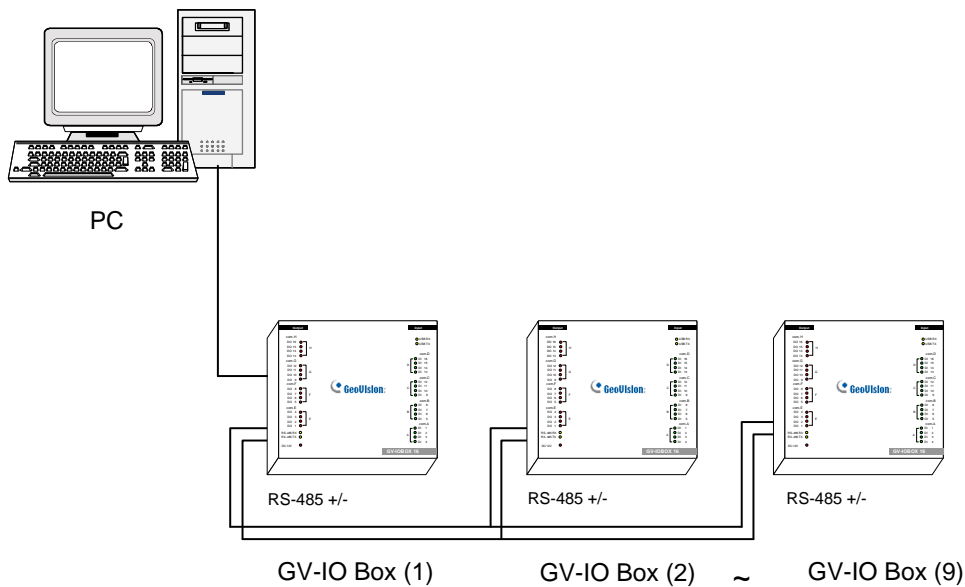

**Note:** The maximum distance for RS-485 connection is up to 600 m / 1968.5 ft.

### ID Switch



ID

1. Addresses 0 and A to F are NOT functional.
2. Assign the addresses when the power is off.
3. If you want to change the assigned address of the connected GV-IO Box, set the switch to the new address and re-plug the power adaptor.

### 7.3 Extending Transmission over the Distance

When the transmission signals between the RS-485 communications become weak over the distance, switch on the Terminal Resistance Switches to maintain their stability. Three conditions below illustrate the typical scenarios in which the Terminal Resistance Switches should be switched on.

#### 1. Multiple pieces of GV-IO Box are connected to a PC through one single RS-485 cable.

After you connect multiple pieces of GV-IO Box with a PC, only switch on the Terminal Resistance Switches in the first and last connected pieces of GV-IO Box.

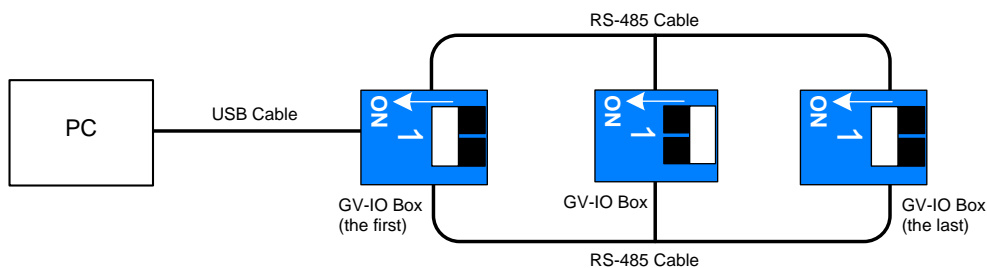

**Note:** If you connect **GV-IO Box 4 Ports** as the first device to a PC, do not use the USB cable. Instead, use the RS-485 cable and you need the optional device GV-Hub, GV-COM, GV-NET Card or GV-NET/IO, to connect the RS-485 device to the PC.

#### 2. Multiple pieces of GV-IO Box are connected to a PC through a RS-485 converter.

After you connect multiple pieces of GV-IO Box with a PC through a RS-485 converter, such as GV-NET/IO Card and GV-Hub, insert a Terminal Resistor in the converter and switch on the Terminal Resistance Switch of the last connected GV-IO Box.

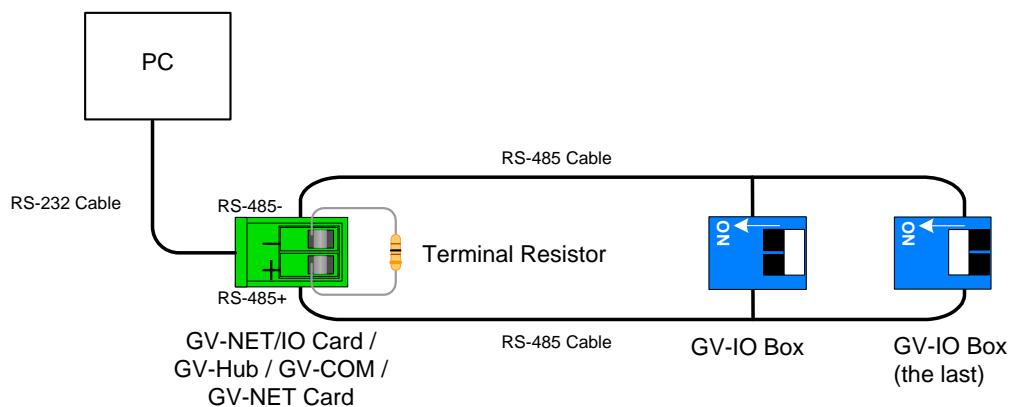

**3. Multiple pieces of GV-IO Box are connected to a PC through separate RS-485 cables.**

After you connect multiple pieces of GV-IO Box to a PC through separate RS-485 cables, switch on Terminal Resistance Switches of the connected piece of GV-IO Box at the end of each cable.

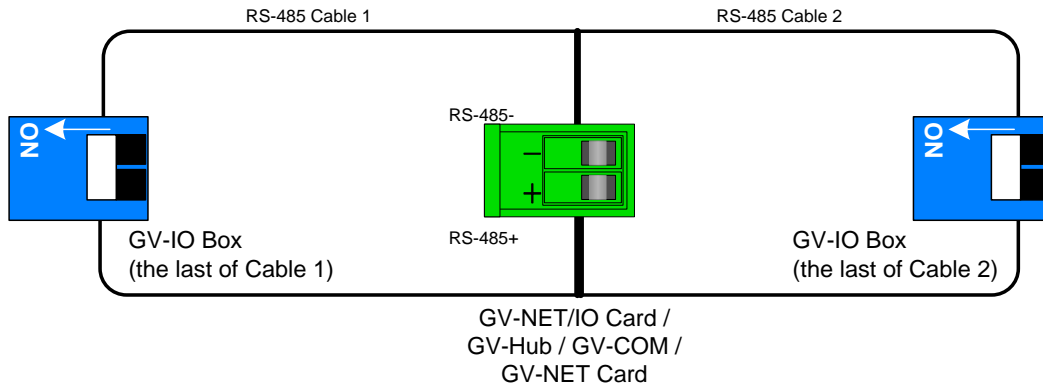

**Terminal Resistance Switch**

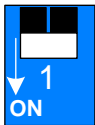

The default setting of the Switch is OFF. To switch on the Terminal Resistance Switch, push the switch downward.

## 8. Accessing GV-IO Box 16 Ports over Networks

You can link the GV-IO Box to GV-DVR / NVR / VMS, GV-ASManager and GV-Control Center over networks for IO management. While accessing the GV-IO Box, make sure the connected network is stable and the following system requirement is met:

- Microsoft Internet Explorer 8.0 or later

**Note:** For I/O management over network, **GV-IO Box 16E** is required.

There are three ways to set up GV-IO Box on a network:

1. By default, when the GV-IO Box is connected to a network with DHCP server, a dynamic IP address is assigned to the GV-IO Box.
2. When the DHCP server on your network is unavailable or disabled, the GV-IO Box is accessible by the default IP **192.168.0.100**. See *7.1 Fixed IP Connection* for details.
3. You may also use the DDNS (Dynamic Domain Name system) instead of an IP address to access the GV-IO Box. For details on the domain name service, see *7.2 DHCP Connection*.

**Note:** Notice these specifications for GeoVision software applications:

1. GV-IO Box is linked to GV-DVR / NVR / VMS by using the **Virtual IO** function. GV-DVR / NVR / VMS supports up to 9 IO modules which include real and virtual IO devices linked through the network.
2. Up to 16 connections from GeoVision software are allowed to control one GV-IO Box.

## 8.1 Fixed IP Connection

To assign GV-IO Box to a fixed IP:

1. Open an Internet browser, and type the default IP address <https://192.168.0.100>. The login dialog box appears.
2. Type default value **admin** for both Username and Password, and click **OK**. This page appears.

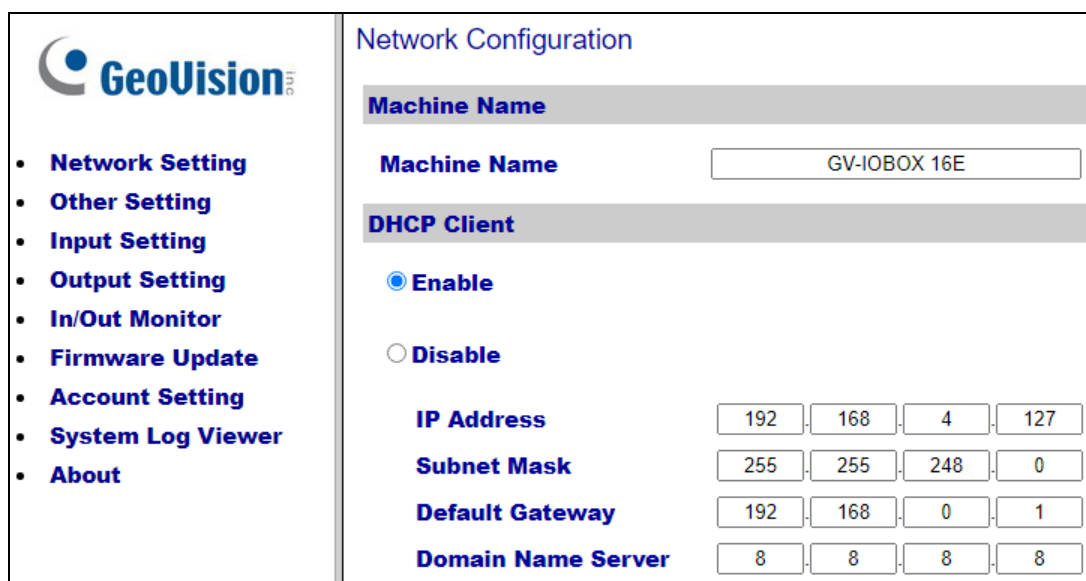

Network Configuration				
<b>Machine Name</b>				
Machine Name	<input type="text" value="GV-IOBOX 16E"/>			
<b>DHCP Client</b>				
<input checked="" type="radio"/> Enable				
<input type="radio"/> Disable				
IP Address	<input type="text" value="192"/>	<input type="text" value="168"/>	<input type="text" value="4"/>	<input type="text" value="127"/>
Subnet Mask	<input type="text" value="255"/>	<input type="text" value="255"/>	<input type="text" value="248"/>	<input type="text" value="0"/>
Default Gateway	<input type="text" value="192"/>	<input type="text" value="168"/>	<input type="text" value="0"/>	<input type="text" value="1"/>
Domain Name Server	<input type="text" value="8"/>	<input type="text" value="8"/>	<input type="text" value="8"/>	<input type="text" value="8"/>

3. In the Machine Name field, edit the name of the connected GV-IO Box.
4. Click **Disable**. Type the static IP address information, including IP Address, Subnet Mask, Default Gateway and Domain Name Server.
5. Click **Submit**. When the setting is complete, the Status field will indicate *Register Success*. Then GV-IO Box can be accessed through the fixed IP address.

**Note:** If want to use the domain name instead of an IP address, you may use the Domain Name Service. For details on domain name service, see [7.2 DHCP Connection](#).

## 8.2 DHCP Connection

DDNS (Dynamic Domain Name System) provides another way of accessing GV-IO Box when using a dynamic IP from a DHCP server. DDNS assigns a domain name to GV-IO Box so that GV servers can always access GV-IO Box by using the domain name.

To enable the DDNS function, first you should apply for a domain name from the DDNS service provider's website. There are 2 providers listed in GV-IO Box: **GeoVision DDNS Server** and **DynDNS.org**. To register at GeoVision DDNS Server, see the following instructions. For details on DynDNS, please consult them at [www.dyndns.org](http://www.dyndns.org).

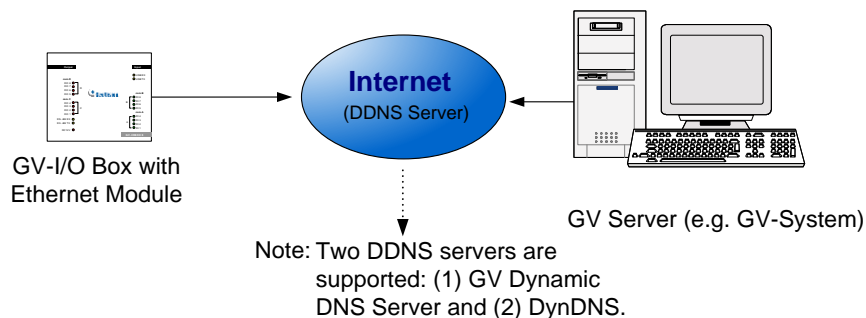

### Registering a DDNS Domain Name

To obtain a domain name from the GeoVision DDNS Server:

1. Click the **GeoVision DDNS** button on the Network Configuration page. Or open an Internet browser and type the Web address <http://ns.dipmap.com/register.aspx>. This page appears.

## DynamicDNS01

**Register**

<p>Username: <input type="text" value="Somerset01"/></p> <p>Password: <input type="password" value="*****"/></p> <p>Re-type Password: <input type="password" value="*****"/></p>	<p><b>Username</b></p> <p>Username is 16-character maximum; username may not start with spaces or minus signs ("-"). Username will be your hostname.</p> <p><b>Password</b></p> <p>The password is case-sensitive.</p>
<p>Enter the characters as they are shown in the box below. <input type="text" value="i8UCY"/></p> 	<p><b>Word Verification</b></p> <p>This step helps us prevent automated registrations.</p>

2. In the Username field, type a name. Username can be up to 16 characters with the choices of “a ~ z”, “0 ~9”, and “-”. Note that space or “-” cannot be used as the first character.
3. In the Password field, type a password. Passwords are case-sensitive and must be at least 6 characters. Type the password again in the Re-type Password field for confirmation.
4. In the Word Verification section, type the characters or numbers shown in the box. For example, type *i8UCY* in the required field. Word Verification is not case-sensitive.
5. Click the **Send** button. When the registration is complete, this page will appear. The **Hostname** is the domain name, consisting of the registered username and “dipmap.com”, e.g. somerset01.dipmap.com.

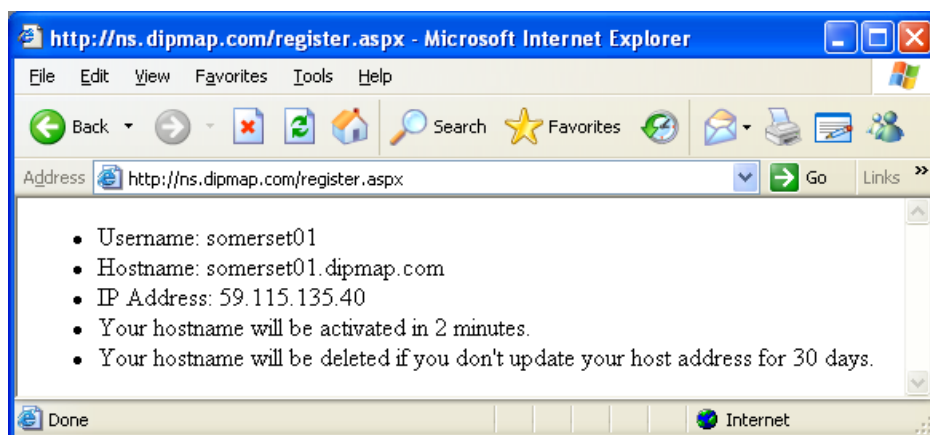

**Note:** The registered username will be invalid if it is not used for over a month.

### 8.3 Configuring GV-IO Box on Internet

After acquiring a domain name from the DDNS Server, you need to configure the domain name on GV-IO Box so that GV servers can access GV-IO Box by using the domain name on the Internet.

1. Follow Steps 1 and 2 in *7.1 Fixed IP Connection* section. The Network Configuration page appears.
2. Click **Enable** and select **Send to DDNS**.
3. Type **Host Name**, **User Name** and **Password** that are registered on the DDNS Server. If you select GeoVision DDNS, the system will automatically bring up the Host Name.

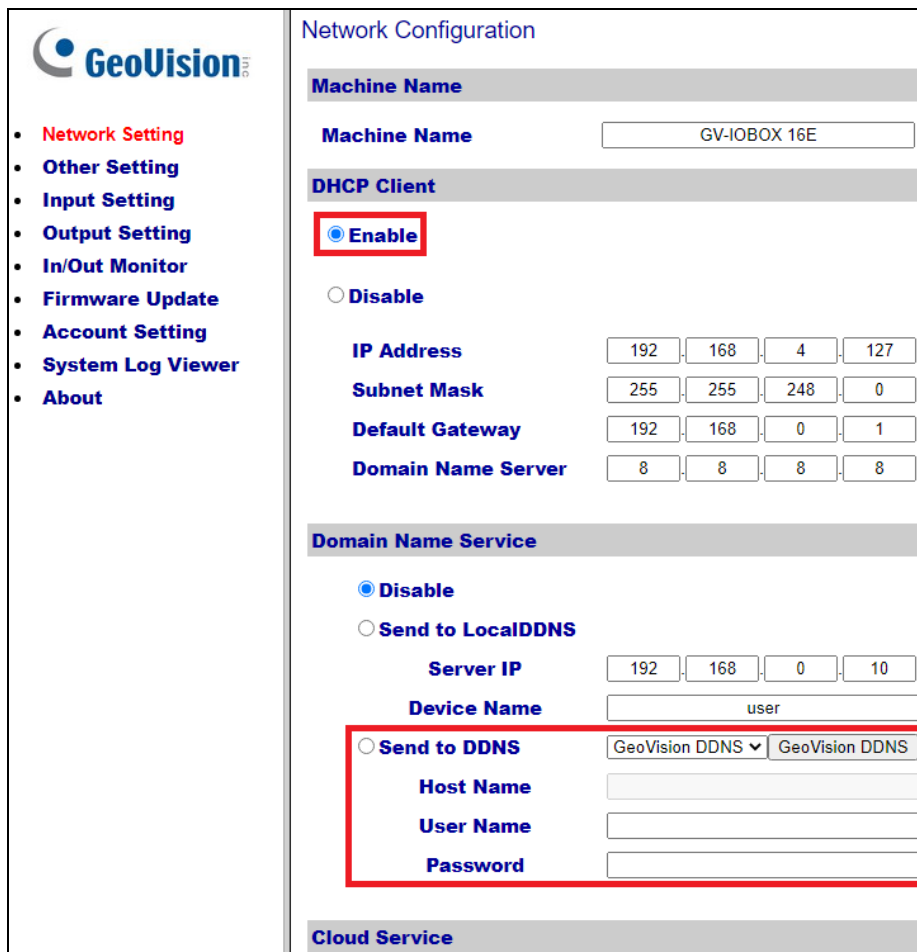

The screenshot shows the 'Network Configuration' page. On the left is a navigation menu with 'Network Setting' highlighted. The main content area is divided into sections: 'Machine Name' (with a text input 'GV-IOBOX 16E'), 'DHCP Client' (with 'Enable' selected and highlighted), and 'Domain Name Service' (with 'Send to DDNS' selected and highlighted, along with a dropdown menu set to 'GeoVision DDNS' and input fields for 'Host Name', 'User Name', and 'Password').

4. Click **Submit**. When the setting is complete, the Status field will indicate: Register Success. Then GV-IO Box can be accessed with this domain name.

## 8.4 Enabling the Cloud Service

The Cloud Service enables you to assign your GV-IO Box 16 Ports to a GV-Cloud Center account so you can use the GV-IoT mobile app to define the input and output pins and trigger output devices remotely. For details, see the [GV-IoT Installation Guide](#).

1. In the left menu, click **Network Setting**. When the Network Configuration page appears, scroll down to the Cloud Service section.

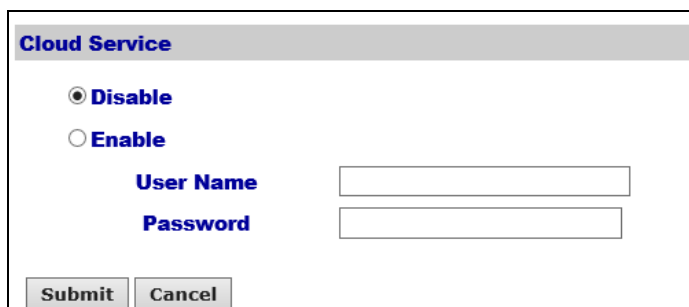

The screenshot shows a web form titled "Cloud Service". It contains two radio buttons: "Disable" (which is selected) and "Enable". Below these are two text input fields labeled "User Name" and "Password". At the bottom of the form are two buttons: "Submit" and "Cancel".

2. Click **Enable** and enter your GV-Cloud Center **User Name** and **Password**.
3. Click **Submit** to save the settings.

## 8.5 Other Setting

In the left menu, click **Other Setting**. This page appears.

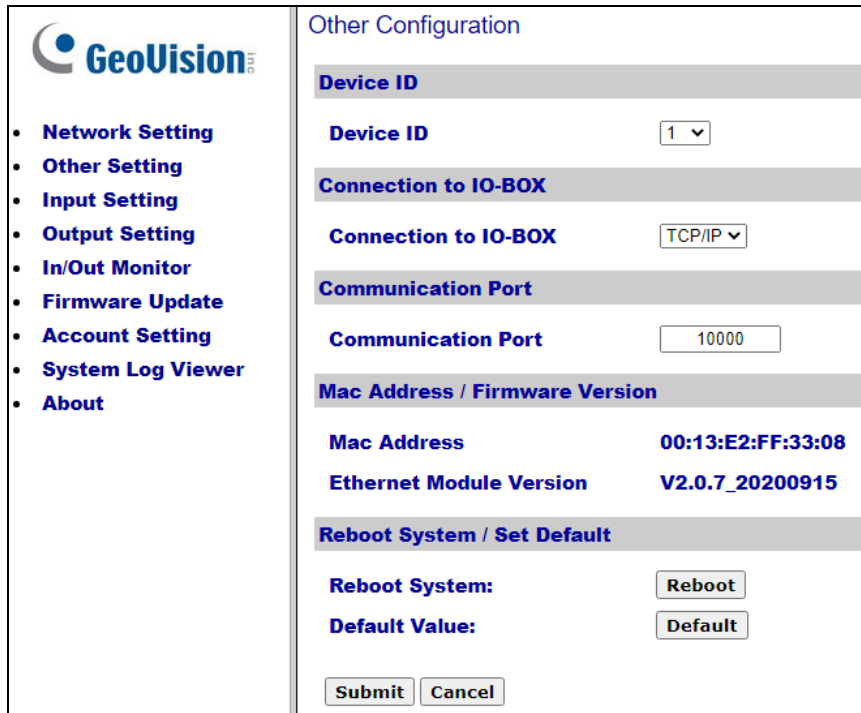

**[Device ID]** Indicates the current ID of the device.

**[Connection to IO-BOX]** Select **Enable** to use GV-IO Box through a network or select **Disable** to use GV-IO Box through USB or RS-485 connection. GV-IO Box cannot support more than one method simultaneously.

**[Communication Port]** Keeps the default port value **10000**.

**[Mac Address/Firmware Version]** Indicates the MAC address of the network medium and the Ethernet module version of GV-IO Box.

### **[Reboot System/Set Default]**

- **Reboot System:** Performs a warm boot of GV-IO Box. This operation keeps the current configuration.
- **Default Value:** Resets all configuration parameters back to factory settings. This may take 5 seconds to complete.

**Note:** If you switch the connection from USB or RS-485 to network, first remove the USB or RS-485 cable from GV-IO Box before selecting **Enable** in this setting page; otherwise, the network connection will not function.

## 8.6 Input Setting

In the left menu, click Input Setting. This page appears.

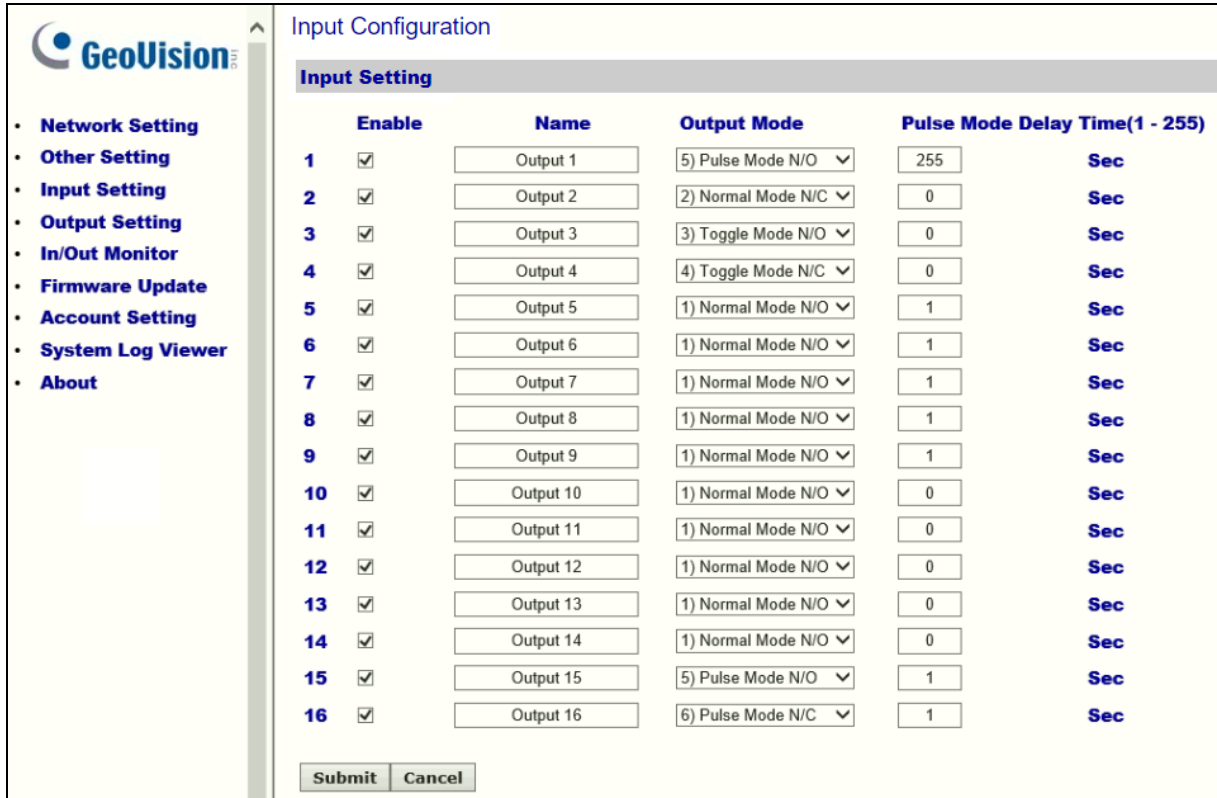

The screenshot shows the 'Input Configuration' page with a sidebar menu on the left containing: Network Setting, Other Setting, Input Setting (selected), Output Setting, In/Out Monitor, Firmware Update, Account Setting, System Log Viewer, and About. The main content area is titled 'Input Configuration' and 'Input Setting'. It contains a table with 16 rows, each representing an input channel. Each row has columns for 'Enable', 'Name', 'Output Mode', and 'Pulse Mode Delay Time(1 - 255) Sec'. All 'Enable' checkboxes are checked. The 'Name' column contains 'Output 1' through 'Output 16'. The 'Output Mode' column contains various modes like '5) Pulse Mode N/O', '2) Normal Mode N/C', '3) Toggle Mode N/O', '4) Toggle Mode N/C', and '1) Normal Mode N/O'. The 'Pulse Mode Delay Time' column contains numerical values: 255, 0, 0, 0, 1, 1, 1, 1, 1, 0, 0, 0, 0, 0, 1, 1. At the bottom of the table are 'Submit' and 'Cancel' buttons.

	Enable	Name	Output Mode	Pulse Mode Delay Time(1 - 255)	Sec
1	<input checked="" type="checkbox"/>	Output 1	5) Pulse Mode N/O	255	Sec
2	<input checked="" type="checkbox"/>	Output 2	2) Normal Mode N/C	0	Sec
3	<input checked="" type="checkbox"/>	Output 3	3) Toggle Mode N/O	0	Sec
4	<input checked="" type="checkbox"/>	Output 4	4) Toggle Mode N/C	0	Sec
5	<input checked="" type="checkbox"/>	Output 5	1) Normal Mode N/O	1	Sec
6	<input checked="" type="checkbox"/>	Output 6	1) Normal Mode N/O	1	Sec
7	<input checked="" type="checkbox"/>	Output 7	1) Normal Mode N/O	1	Sec
8	<input checked="" type="checkbox"/>	Output 8	1) Normal Mode N/O	1	Sec
9	<input checked="" type="checkbox"/>	Output 9	1) Normal Mode N/O	1	Sec
10	<input checked="" type="checkbox"/>	Output 10	1) Normal Mode N/O	0	Sec
11	<input checked="" type="checkbox"/>	Output 11	1) Normal Mode N/O	0	Sec
12	<input checked="" type="checkbox"/>	Output 12	1) Normal Mode N/O	0	Sec
13	<input checked="" type="checkbox"/>	Output 13	1) Normal Mode N/O	0	Sec
14	<input checked="" type="checkbox"/>	Output 14	1) Normal Mode N/O	0	Sec
15	<input checked="" type="checkbox"/>	Output 15	5) Pulse Mode N/O	1	Sec
16	<input checked="" type="checkbox"/>	Output 16	6) Pulse Mode N/C	1	Sec

- **Enable:** Select to enable this Input function to be used by GV-IO Box.
- **Name:** Name the input. The name is restricted to 16 alphanumeric characters or 5 Chinese characters.
- **Input Mode:** Configure the input to **NC** (normally closed) or **NO** (normally open) mode.
- **Enable Latch:** Instead of a constant output of N/O or N/C, this option provides a momentary alarm when triggered.
- **Alarm Output:** Select **None** for no alarm output, or select between **Output 1** and **Output 16** to trigger when input is detected.

Click the **Submit** button to save the changes, or click the **Cancel** button to return the changes to its previous state.

## 8.7 Output Setting

In the left menu, click **Output Setting**. This page appears.

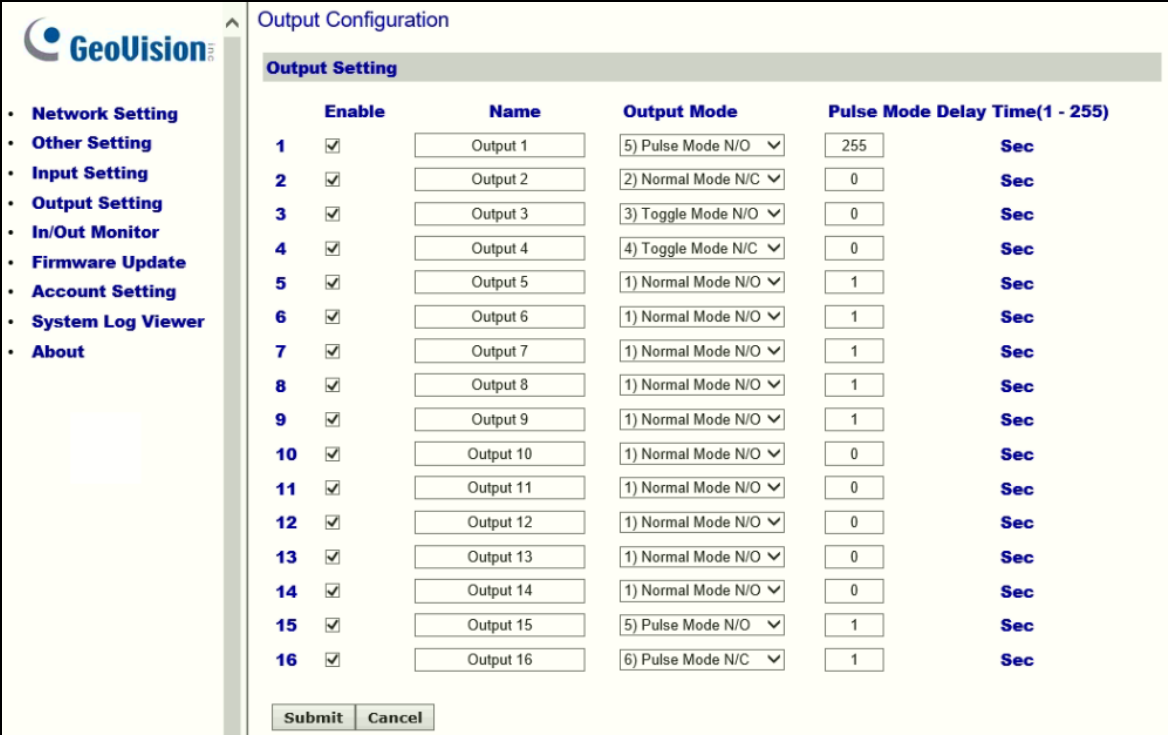

	Enable	Name	Output Mode	Pulse Mode Delay Time(1 - 255)	
1	<input checked="" type="checkbox"/>	Output 1	5) Pulse Mode N/O	255	Sec
2	<input checked="" type="checkbox"/>	Output 2	2) Normal Mode N/C	0	Sec
3	<input checked="" type="checkbox"/>	Output 3	3) Toggle Mode N/O	0	Sec
4	<input checked="" type="checkbox"/>	Output 4	4) Toggle Mode N/C	0	Sec
5	<input checked="" type="checkbox"/>	Output 5	1) Normal Mode N/O	1	Sec
6	<input checked="" type="checkbox"/>	Output 6	1) Normal Mode N/O	1	Sec
7	<input checked="" type="checkbox"/>	Output 7	1) Normal Mode N/O	1	Sec
8	<input checked="" type="checkbox"/>	Output 8	1) Normal Mode N/O	1	Sec
9	<input checked="" type="checkbox"/>	Output 9	1) Normal Mode N/O	1	Sec
10	<input checked="" type="checkbox"/>	Output 10	1) Normal Mode N/O	0	Sec
11	<input checked="" type="checkbox"/>	Output 11	1) Normal Mode N/O	0	Sec
12	<input checked="" type="checkbox"/>	Output 12	1) Normal Mode N/O	0	Sec
13	<input checked="" type="checkbox"/>	Output 13	1) Normal Mode N/O	0	Sec
14	<input checked="" type="checkbox"/>	Output 14	1) Normal Mode N/O	0	Sec
15	<input checked="" type="checkbox"/>	Output 15	5) Pulse Mode N/O	1	Sec
16	<input checked="" type="checkbox"/>	Output 16	6) Pulse Mode N/C	1	Sec

- **Enable:** Select to enable this Output function to be used by GV-IO Box.
- **Name:** Name the output. The name is restricted to 16 alphanumeric characters or 5 Chinese characters.
- **Output Mode:** Configure the input to **NC** (normally closed) or **NO** (normally open) mode.
  - ⊙ **Normal Mode (N/O and N/C):** Output continues to be triggered until the source of the output condition is stopped.
  - ⊙ **Toggle Mode (N/O and N/C):** Output continues to be triggered until a new input trigger ends the output.
  - ⊙ **Pulse Mode (N/O and N/C):** Output is triggered for the amount of time set in the **Pulse Mode Delay Time (1-255)** field.
- **Pulse Mode Delay Time (1-255):** Enter the time in seconds for the pulse delay time between 1 and 255 seconds.

Click the **Submit** button to save the changes, or click the **Cancel** button to return the changes to its previous state.

## 8.8 In/Out Monitor

In the left menu, click **In/Out Monitor**. This page appears.

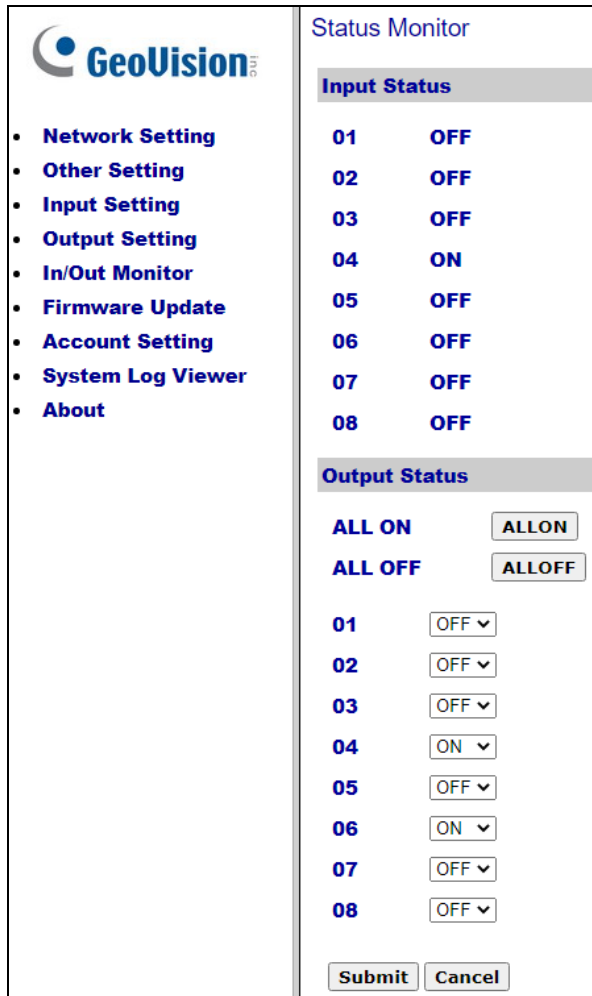

Input Status	
01	OFF
02	OFF
03	OFF
04	ON
05	OFF
06	OFF
07	OFF
08	OFF

Output Status	
ALL ON	<input type="button" value="ALLON"/>
ALL OFF	<input type="button" value="ALLOFF"/>
01	OFF ▾
02	OFF ▾
03	OFF ▾
04	ON ▾
05	OFF ▾
06	ON ▾
07	OFF ▾
08	OFF ▾

- **Input Status:** Indicates the current status of the 16 inputs, whether it is **ON** (triggered) or **OFF** (no input).
- **Output Status:** Indicates the current status of the 16 outputs, whether it is **ON** (triggered) or **OFF** (no output). Click the **ALL ON** button to force all 16 outputs to be triggered. Click the **ALL OFF** button to turn off all 16 outputs. Select the individual outputs to turn it **ON** to force the output to be triggered or turn it **OFF**.

Click the **Submit** button to save the changes, or click the **Cancel** button to return the changes to its previous state.

## 9. Updating Firmware

### IMPORTANT:

1. For firmware update from Version 1.10 or earlier to the latest version, it is required to access the GV-IO Box over the network on Windows XP or Windows 7.
2. The firmware updates to V2.00 are only for Ethernet modules. If you are having updating issues, please contact your local GV vendor or our team at [support@geovision.com.tw](mailto:support@geovision.com.tw) for further assistance.

To update the firmware of GV-IO Box, follow the steps below:

1. In the left menu, click **Firmware Update**. This page appears.

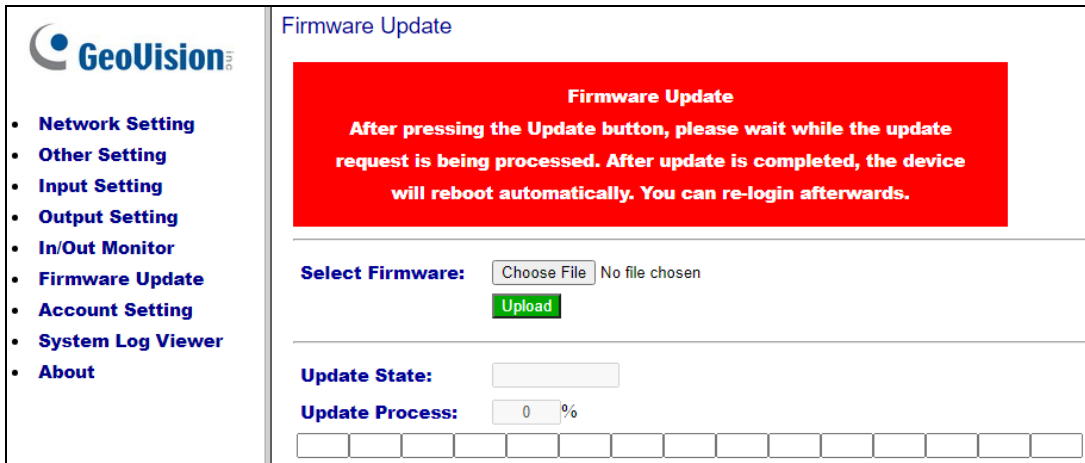

2. Click the **Browse...** button to open the firmware file (\*.bin)
3. Click the **Upload** button. This update procedure may take 60 seconds to complete.
4. When Update is complete, a dialog box appears and asks you to reboot the system.
5. Click **OK**. GV-IO Box starts the Reboot operation.

### Note:

1. It is required to reboot GV-IO Box after updating the firmware. Without rebooting, the firmware update is not complete.
2. Updating of firmware through **GV-IP Device Utility** is only supported when updating from firmware V1.21 or later.

## 10. Changing Login ID and Password

In the left menu, click **Account Setting**. This page appears. You can modify the login name and password. The password is case sensitive and is limited to 4 characters with the choices of “a ~ z” and “0 ~ 9”.

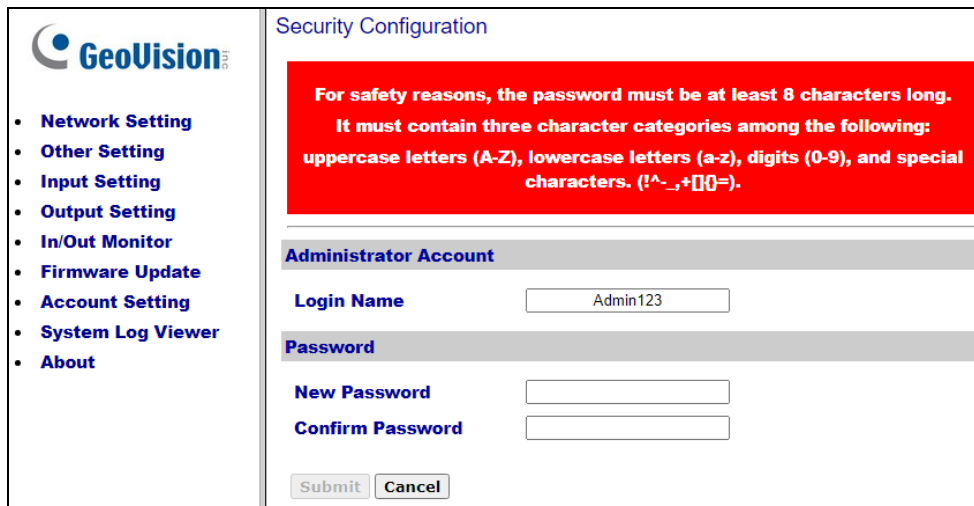

**GeoVision** Inc.

- Network Setting
- Other Setting
- Input Setting
- Output Setting
- In/Out Monitor
- Firmware Update
- **Account Setting**
- System Log Viewer
- About

Security Configuration

**For safety reasons, the password must be at least 8 characters long.  
It must contain three character categories among the following:  
uppercase letters (A-Z), lowercase letters (a-z), digits (0-9), and special  
characters. (!^\_.,+[]{}=).**

**Administrator Account**

**Login Name**

**Password**

**New Password**

**Confirm Password**

## 11. Viewing System Log Information

The system log information contains the current system status and dump data that can be used by service personnel for analyzing problems.

## 12. Specifications

For details, see [Datasheet](#).