

**L2+ Industrial 8-/16-Port 802.3af/at PoE
Managed Switch**

IGS-10020PT/IGS-10020HPT/IGS-20160HPT

Quick Installation Guide

Table of Contents

1. Package Contents	3
2. Requirements	4
3. Wiring the Power Inputs.....	5
3.1 Grounding the Device	7
4. Terminal Setup	8
4.1 Logging on to the Console.....	9
4.2 Configuring IP Address.....	10
5. Starting Web Management	13
5.1 Logging in to the Industrial Managed PoE+ Switch	13
5.2. Saving Configuration.....	17
6. Recovering Back to Default Configuration.....	19
7. Customer Support	20

1. Package Contents

Thank you for purchasing PLANET L2+ Industrial Managed Gigabit PoE+ Switch. The descriptions of these models are as follows:

Model	RJ45 Ports	PoE+ Ports	SFP Ports
IGS-10020PT	8	8	2
IGS-10020HPT	8	8	2
IGS-20160HPT	18	16	2

“**Industrial Managed PoE+ Switch**” mentioned in this Quick Installation Guide refers to the above models.

Open the box of the Industrial Managed PoE+ Switch and carefully unpack it. The box should contain the following items for each of the three models:

Item	IGS-10020PT	IGS-10020HPT	IGS-20160HPT
Quick Installation Guide	■	■	■
DIN-rail Kit	■	■	■
Wall Mounting Kit	■	■	■
DB9 to RJ45 Interface RS232 Console Cable	■	■	■
RJ45 Dust Cap	9	9	19
SFP Dust Cap	2	2	2

If any item is found missing or damaged, please contact your local reseller for replacement.

2. Requirements

- Workstations running Windows XP/2003/2008/2012/Vista/7/8/10, MAC OS X or later, Linux, UNIX, or other platforms are compatible with TCP/IP protocols.
- Serial Port Connection (Terminal)
 - The above Workstations come with COM Port (DB9) or USB-to-RS232 converter.
 - The above Workstations have been installed with terminal emulator, such as Hyper Terminal included in Windows XP/2003, putty or tera term.
 - Serial cable -- one end is attached to the RS232 serial port, while the other end to the RJ45 console port of the Industrial Managed PoE+ Switch.
- Ethernet Port Connection
 - Workstations are installed with Ethernet NIC (Network Interface Card).
 - Network cables -- Use standard network (UTP) cables with RJ45 connectors.
 - The above PC is installed with Web browser.



Note

It is recommended to use Internet Explorer 8.0 or above to access the Industrial Managed PoE+ Switch. If the Web interface of the Industrial Managed PoE+ Switch is not accessible, please turn off the anti-virus software or firewall and then try it again.

3. Wiring the Power Inputs

The Upper Panel of the Industrial Managed PoE+ Switch indicates a DC inlet power socket and consists of one terminal block connector within 6 contacts. Please follow the steps below to insert the power wire.

1. Insert positive/negative DC power wires into Contacts 1 and 2 for Power 1, or Contacts 5 and 6 for Power 2.

- **IGS-10020PT:** 48V~56V DC

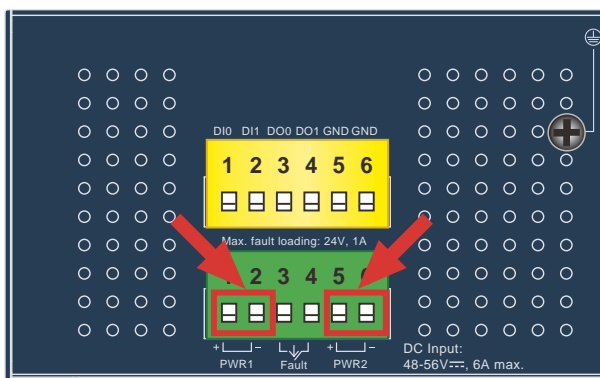

Figure 3-1: IGS-10020PT Upper Panel

- **IGS-10020HPT:** 12~48V DC

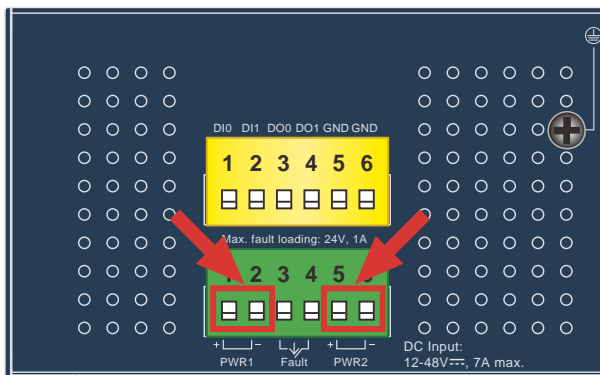

Figure 3-2: IGS-10020HPT Upper Panel

● **IGS-20160HPT: 48-56V DC**

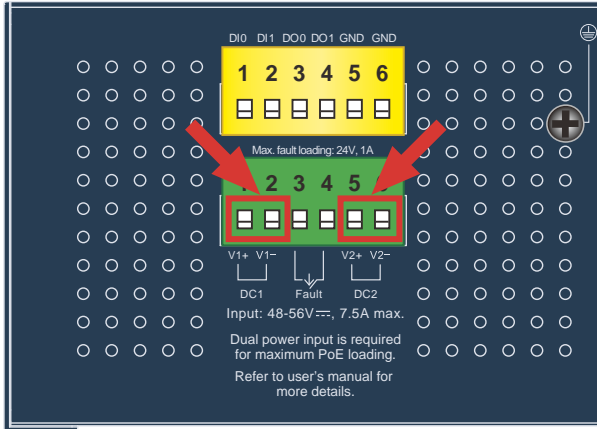

Figure 3-3: IGS-20160HPT Upper Panel

2. Tighten the wire-clamp screws for preventing the wires from loosening.



1 2 3 4 5 6
V1+ V1- V2+ V2-
Power 1 (DC1) Power 2 (DC2)

Model	Positive (+) Pin	Negative (-) Pin
IGS-10020PT/IGS-10020HPT/ IGS-20160HPT	Pin 1 / 5	Pin 2 / 6

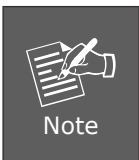

The wire gauge for the terminal block should be in the range from **12** to **24** AWG.

3.1 Grounding the Device

Users **MUST** complete grounding wired with the device; otherwise, a sudden lightning could cause fatal damage to the device.

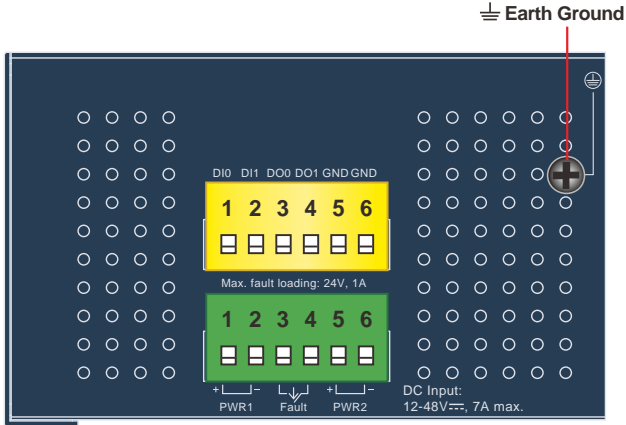

Note

EMD (Lightning) DAMAGE IS NOT COVERED UNDER WARRANTY.

4. Terminal Setup

To configure the system, connect a serial cable to a **COM port** on a PC or notebook computer and to RJ45 type serial (console) port of the Industrial Managed PoE+ Switch. The console port of the Industrial Managed PoE+ Switch is DCE already, so that you can connect the console port directly through PC without the need of null modem.

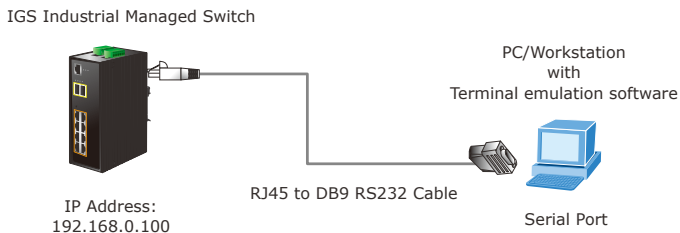

Figure 4-1: Industrial Managed PoE+ Switch Console Connectivity

A terminal program is required to make the software connected to the Industrial Managed PoE+ Switch. Windows' **Hyper Terminal** program may be a good choice. The Hyper Terminal can be accessed from the **Start** menu.

1. Click **START**, then **Programs, Accessories** and then **Hyper Terminal**.
2. When the following screen appears, make sure that the COM port should be configured as:

- ◆ Baud: 115200
- ◆ Parity: None
- ◆ Data Bits: 8
- ◆ Stop Bits: 1
- ◆ Flow Control: None



Figure 4-2: COM Port Configuration

4.1 Logging on to the Console

Once the terminal has been connected to the device, power on the Industrial Managed PoE+ Switch and the terminal will display "running testing procedures".



Note

The following console screen is based on the IGS-10020HPT. The display of the IGS-10020PT and IGS-20160HPT is the same as that of the IGS-10020HPT.

Then, the following message asks to log in user name and password as shown in Figure 4-3. Please enter the factory default user name "**admin**" and password "**admin**".

User Name: **admin**

Password: **admin**

```
> diag -p
> fis load -x linux
MD5 signature validated
Stage1: 0x80100000, length 4507080 bytes
Initrd: 0x80600000, length 188416 bytes
Kernel command line: init=/usr/bin/stage2-loader loglevel=4
> exec
Now booting linux kernel:
Base address 0x80080000 Entry 0x80100000
Cmdline : init=/usr/bin/stage2-loader loglevel=4
Active fis: linux
[ 0.371597] mx35 spi0.3: NAND Flash Disable (Caracal)
00:00:00 Stage 1 booted
00:00:01 Loading stage2 from NOR flash partition 'linux'
00:00:18 Overall: 17443 ms, ubifs = 1131 ms, rootfs 16141 ms of which xz = 0 ms
of which untar = 0 ms
00:00:37 Starting application...
Using existing mount point for /switch/

Press ENTER to get started

Username: admin
Password:
IGS-10020HPT#
```

Figure 4-3: Console Login Screen



Note

1. For security reason, **please change and memorize the new password after this first setup.**
2. Only accept command in lowercase letter under console interface.

4.2 Configuring IP Address

The Industrial Managed PoE+ Switch is shipped with default IP address shown below:

IP Address: **192.168.0.100**
Subnet Mask: **255.255.255.0**

To check the current IP address or modify a new IP address for the Industrial Managed PoE+ Switch, please use the procedure as follows:

■ Display of the current IP Address

1. At the “#” prompt, enter “**show ip interface brief**”.
2. The screen displays the current IP address shown in Figure 4-4.

```
Press ENTER to get started
Username: admin
Password:
IGS-10020HPT# show ip interface brief
Interface Address Method Status
-----
VLAN 1 192.168.0.100/24 Manual DOWN
IGS-10020HPT#
```

Figure 4-4: IP Information Screen

■ Configuration of the IP Address

3. At the “#” prompt, enter the following command and press **<Enter>** as shown in Figure 4-5.

```
IGS-10020HPT# configure terminal
IGS-10020HPT(config)# interface vlan 1
IGS-10020HPT(config-if-vlan)# ip address 192.168.1.100 255.255.255.0
```

The previous command would apply the following settings for the Industrial Managed PoE+ Switch.

IP Address: **192.168.1.100**
Subnet Mask: **255.255.255.0**

```
Press ENTER to get started
Username: admin
Password:
IGS-10020HPT# show ip interface brief
Interface Address Method Status
-----
VLAN 1 192.168.0.100/24 Manual DOWN
IGS-10020HPT# configure terminal
IGS-10020HPT(config)# interface vlan 1
IGS-10020HPT(config-if-vlan)# ip address 192.168.1.100 255.255.255.0
IGS-10020HPT(config-if-vlan)#
```

Figure 4-5: Configuring IP Address Screen

4. Repeat step 1 to check if the IP address has changed.

■ Store the current switch configuration

5. At the “#” prompt, enter the following command and press <Enter>.

```
# copy running-config startup-config
```

```
Press ENTER to get started
Username: admin
Password:
IGS-10020HPT# show ip interface brief
Interface  Address                Method  Status
-----
VLAN 1    192.168.0.100/24      Manual  DOWN
IGS-10020HPT# configure terminal
IGS-10020HPT(config)# interface vlan 1
IGS-10020HPT(config-if-vlan)# ip address 192.168.1.100 255.255.255.0
IGS-10020HPT(config-if-vlan)# exit
IGS-10020HPT(config)# exit
IGS-10020HPT# copy running-config startup-config
Building configuration...
do not reset or power off the device!
% Saving 3089 bytes to flash:startup-config
IGS-10020HPT#
```

Figure 4-6: Saving Current Configuration Command Screen

If the IP is successfully configured, the Industrial Managed PoE+ Switch will apply the new IP address setting immediately. You can access the Web interface of the Industrial Managed PoE+ Switch through the new IP address.



Note

If you are not familiar with the console command or the related parameter, enter “**help**” anytime in console to get the help description.

5. Starting Web Management

The following shows how to start up the **Web Management** of the Industrial Managed PoE+ Switch. Note the Industrial Managed PoE+ Switch is configured through an Ethernet connection. Please make sure the manager PC must be set to the same **IP subnet address**.

For example, the default IP address of the Industrial Managed PoE+ Switch is **192.168.0.100**, then the manager PC should be set to **192.168.0.x** (where x is a number between 1 and 254, except 100), and the default subnet mask is 255.255.255.0.

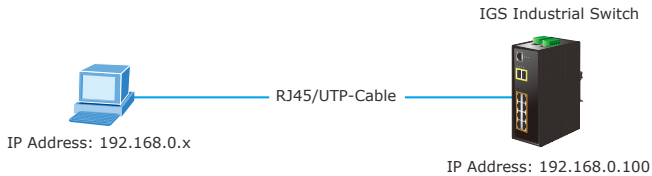

Figure 5-1: IP Management Diagram

5.1 Logging in to the Industrial Managed PoE+ Switch

1. Use Internet Explorer 8.0 or above for Web browser and enter IP address **<http://192.168.0.100>** (the factory-default IP address) to access the Web interface.
2. When the following dialog box appears, please enter the default user name "**admin**" and password "**admin**" (or the password you have changed before) as shown in Figure 5-2.

Default IP Address: **192.168.0.100**

Default User Name: **admin**

Default Password: **admin**



Figure 5-2: Web Login Screen



The following web screen based on IGS-10020HPT will be the same as that of IGS-10020PT/IGS-20160HPT.

3. After entering the password, the main screen appears as shown in Figure 5-3.



Figure 5-3: Web Main Screen of Industrial Managed PoE+ Switch

The Switch Menu on the top of the Web page lets you access all the commands and statistics the Industrial Managed PoE+ Switch provides. The Switch Menu always contains one or more buttons, such as **"System"**, **"Switching"**, **"QoS"**, **"Security"**, **"PoE"**, **"Ring"**, **"ONVIF"** and **"Maintenance"**.



Figure 5-4: Switch Menu



Figure 5-5: Switch Menu -- System

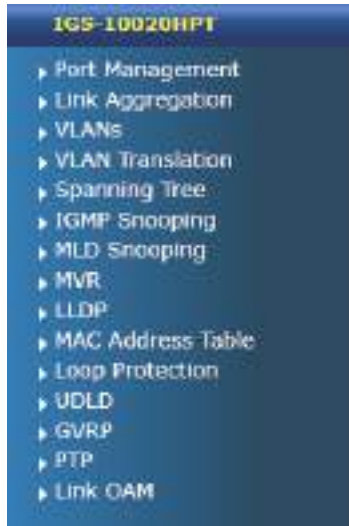

Figure 5-6: Switch Menu – Switching

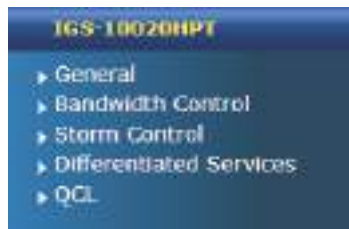

Figure 5-7: Switch Menu -- QoS



Figure 5-8: Switch Menu -- Maintenance



Figure 5-9: Switch Menu -- Security

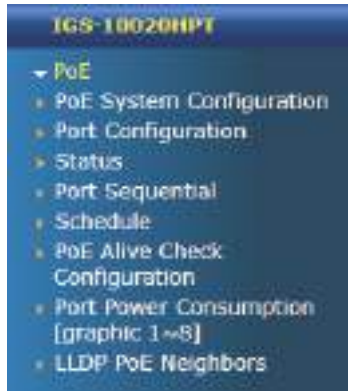

Figure 5-10: Switch Menu -- PoE



Figure 5-11: Switch Menu -- Ring



Figure 5-12: Switch Menu – ONVIF



Note

If you are not familiar with Switch functions or the related parameter, press **"Help icon"** anytime on the Web page to get the help description.

Now, you can use the Web management interface to continue the Switch management or manage the Switch by console interface.

Please refer to the user's manual for more.

5.2. Saving Configuration

To save all applied changes and set the current configuration as a startup configuration on the Web user interface, the startup-configuration file will be loaded automatically across a system reboot.

1. Click the **Save** icon on the top Switch Menu bar.



Figure 5-13: Save Config -- Hot Key

2. Press the **"Save Configuration"** button.



3. Or the other way to save the setting is to Click **Maintenance, Save Startup Config**.



Figure 5-14: Save Config -- Maintenance

6. Recovering Back to Default Configuration

To reset the IP address to the default IP address **“192.168.0.100”** and the user password to factory default mode (default password is **admin**), press the hardware-based reset button on the front panel for about 10 seconds. After the device is rebooted, you can log in the management Web interface within the same subnet of 192.168.0.xx and default password. Be noted that all the previous setups will be disappeared after the factory default reset is made.

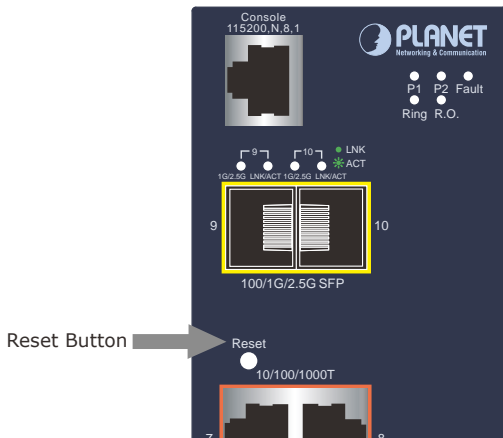

Figure 6-1: IGS-10020PT/IGS-10020HPT Reset Button

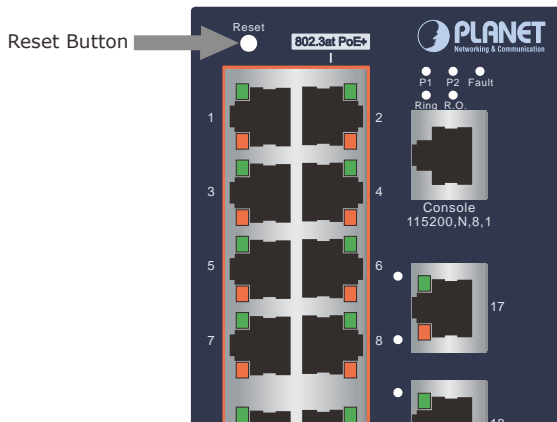

Figure 6-2: IGS-20160HPT Reset Button

7. Customer Support

Thank you for purchasing PLANET products. You can browse our online FAQ resource on PLANET web site first to check if it could solve your issue. If you need more support information, please contact PLANET switch support team.

PLANET online FAQs:

<http://www.planet.com.tw/en/support/faq>

Switch support team mail address:

support@planet.com.tw

IGS-10020PT/IGS-10020HPT/IGS-20160HPT User's Manual:

<https://www.planet.com.tw/en/support/downloads?method=keyword&keyword=IGS&view=3&page=1#list>



(Please select your switch model name from the Product Model drop-down menu.)

Copyright © PLANET Technology Corp. 2021.

Contents are subject to revision without prior notice.

PLANET is a registered trademark of PLANET Technology Corp.

All other trademarks belong to their respective owners.

**L2+ Industrial 8-Port 10/100/1000T 802.3at PoE + 2-Port
1G/2.5G SFP Managed Switch with USB Console**

IGS-10020HPT-U

Quick Installation Guide

Table of Contents

1. Package Contents.....	3
2. Requirements.....	4
3. Wiring the Power Inputs	5
3.1 Grounding the Device.....	6
4. Terminal Setup.....	7
4.1 Logging on to the Console.....	8
4.2 Configuring IP Address.....	8
5. Starting Web Management	11
5.1 Logging in to the Industrial Managed PoE+ Switch	12
5.2. Saving Configuration	14
6. Recovering Back to Default Configuration	15
7. Customer Support	16

1. Package Contents

Thank you for purchasing PLANET L2+ Industrial 8-Port 10/100/1000T 802.3at PoE + 2-Port 1G/2.5G SFP Managed Switch with USB Console, IGS-10020HPT-U. **"Industrial Managed PoE+ Switch"** mentioned in this Quick Installation Guide refers to the IGS-10020HPT-U.

Open the box of the Industrial Managed PoE+ Switch and carefully unpack it. The box should contain the following items.

Industrial Managed PoE+ Switch x 1	QR Code Sheet x 1	Wall-mount Kit w/ Screws x 1 Set
		
DIN-rail Kit w/Screws x 1	RJ45 Dust Cap x 8	SFP Dust Cap x 2
		

If any item is found missing or damaged, please contact your local reseller for replacement.

2. Requirements

The Industrial Managed PoE+ Switch provides local and remote login interface for management purposes. The following equipment is necessary for further management:

- Workstations running Windows XP/2003/2008/2012/Vista/7/8/10/11, MAC OS X or later, Linux, UNIX, or other platforms are compatible with TCP/IP protocols.
- **Serial Port Connection** (Terminal)
 - The above Workstations have been installed with terminal emulator, such as Hyper Terminal included in Windows XP/2003, putty or tera term.
 - **USB cable** -- one end is attached to the USB port, while the other end to the micro USB connector of the Industrial Managed PoE+ Switch.
- **Ethernet Port Connection**
 - Workstations are installed with Ethernet NIC (Network Interface Card)
 - Network cables -- Use standard network (UTP) cables with RJ45 connectors.
 - The above PC is installed with Web browser.



Note

It is recommended to use Chrome 98.0.xxx or above to access the Industrial Managed PoE+ Switch. If the Web interface of the Industrial Managed PoE+ Switch is not accessible, please turn off the anti-virus software or firewall and then try it again.

3. Wiring the Power Inputs

The Upper Panel of the Industrial Managed PoE+ Switch indicates a DC inlet power socket and consists of one terminal block connector within 6 contacts. Please follow the steps below to insert the power wire.

1. Insert positive/negative DC power wires into Contacts 1 and 2 for Power 1, or Contacts 5 and 6 for Power 2.

● **IGS-10020HPT-U: DC 12-54V**

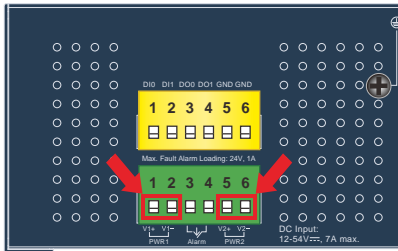
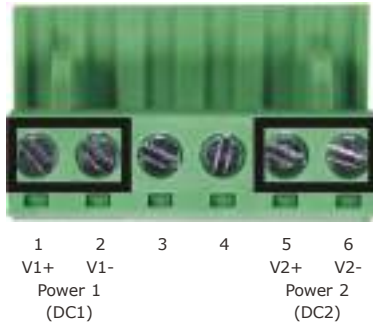

Figure 3-1: IGS-10020HPT-U Upper Panel

2. Tighten the wire-clamp screws for preventing the wires from loosening.



Model	Positive (+) Pin	Negative (-) Pin
IGS-10020HPT-U	Pin 1 / 5	Pin 2 / 6



Note

1. The wire gauge for the terminal block should be in the range from **12** to **24** AWG.
2. Please check the wire AWG Ampere specification before connecting PLANET Industrial Managed PoE+ Switch.



Caution

PWR1 and PWR2 must provide the **same DC voltage** while operating with dual power input.

3.1 Grounding the Device

Users **MUST** complete grounding wired with the device; otherwise, a sudden lightning could cause fatal damage to the device.

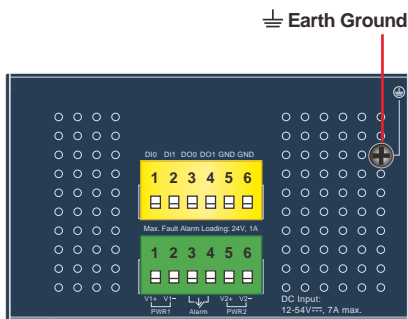

Note

EMD (Lightning) damage is not covered under warranty.

4. Terminal Setup

To configure the system, connect a USB cable to a **USB port** on a PC or notebook computer and to the **micro USB connector** (console) of the Industrial Managed PoE+ Switch.

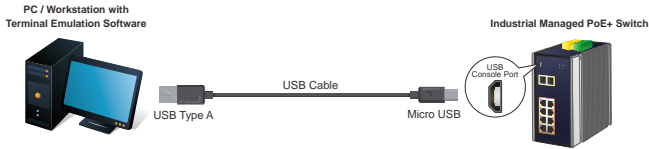

Figure 4-1: Industrial Managed PoE+ Switch USB Console Connectivity



Note

The box of the Industrial Managed PoE+ Switch does not contain any USB cable.

A terminal program is required to make the software connected to the Industrial Managed PoE+ Switch.

1. Run terminal program on the OS, such as Putty or Tera Term.
2. When the following screen appears, make sure that the COM port should be configured as:
 - Baud: 115200
 - Parity: None
 - Data Bits: 8
 - Stop Bits: 1
 - Flow Control: None



Figure 4-2: COM Port Configuration

4.1 Logging on to the Console

Once the terminal has been connected to the device, power on the Industrial Managed PoE+ Switch and the terminal will display “running testing procedures”.

Then, the following message asks to log in user name and password as shown in Figure 4-3. Please enter the factory default user name “**admin**” and password “**admin**”.

User Name: **admin**
Password: **admin**

```
Username: admin
Password:
IGS-10020HPT-U#
```

Figure 4-3: Console Login Screen



Note

1. For security reason, **please change and memorize the new password after this first setup.**
2. Only accept command in lowercase letter under console interface.

4.2 Configuring IP Address

The Industrial Managed PoE+ Switch is shipped with default IP address shown below:

IP Address: **192.168.0.100**
Subnet Mask: **255.255.255.0**

To check the current IP address or modify a new IP address for the Industrial Managed PoE+ Switch, please use the procedure as follows:

■ Display of the current IP Address

1. At the “#” prompt, enter “**show ip interface brief**”.
2. The screen displays the current IP address shown in Figure 4-4.

```
IGS-10020HPT-U# show ip interface brief
Interface  Address                Method  Status
-----
VLAN 1    192.168.0.100/24      Manual  UP
IGS-10020HPT-U#
```

Figure 4-4: IP Information Screen

■ Configuration of the IP Address

3. At the “#” prompt, enter the following command and press <Enter> as shown in Figure 4-5.

The previous command would apply the following settings for the Industrial Managed PoE+ Switch.

```
IP Address: 192.168.1.100
Subnet Mask: 255.255.255.0
```

```
IGS-10020HPT-U# configure terminal
IGS-10020HPT-U(config)# interface vlan 1
IGS-10020HPT-U(config-if-vlan)# ip address 192.168.1.100 255.255.255.0
```

Figure 4-5: Configuring IP Address Screen

4. Repeat step 1 to check if the IP address has changed.

■ Store the current switch configuration

5. At the “#” prompt, enter the following command and press **<Enter>**.

```
# copy running-config startup-config
```

```
IGS-10020HPT-U# copy running-config startup-config
Building configuration...
do not reset or power off the device!
% Saving 3425 bytes to flash:startup-config
IGS-10020HPT-U#
```

Figure 4-6: Saving Current Configuration Command Screen

If the IP is successfully configured, the Industrial Managed PoE+ Switch will apply the new IP address setting immediately. You can access the Web interface of the Industrial Managed PoE+ Switch through the new IP address.



Note

If you are not familiar with the console command or the related parameter, enter “**help**” anytime in console to get the help description.

5. Starting Web Management

The following shows how to start up the **Web Management** of the Industrial Managed PoE+ Switch. Note the Industrial Managed PoE+ Switch is configured through an Ethernet connection. Please make sure the manager PC must be set to the same **IP subnet address**.

For example, the default IP address of the Industrial Managed PoE+ Switch is **192.168.0.100**, then the manager PC should be set to **192.168.0.x** (where x is a number between 1 and 254, except 100), and the default subnet mask is 255.255.255.0.

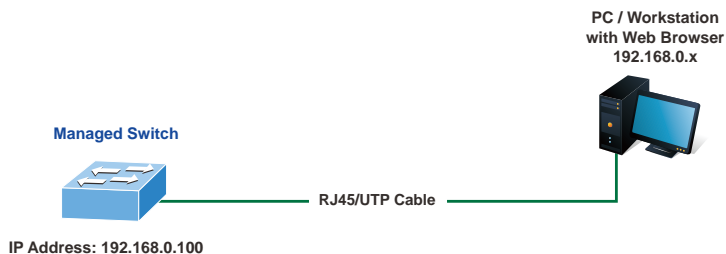

Figure 5-1: IP Management Diagram

5.1 Logging in to the Industrial Managed PoE+ Switch

1. Use Chrome 98.0.xxx or above for Web browser and enter IP address **https://192.168.0.100** (the factory-default IP address) to access the Web interface.
2. When the following dialog box appears, please enter the default user name “**admin**” and password “**admin**” (or the password you have changed before) as shown in Figure 5-2.

Default IP Address: **192.168.0.100**
Default User Name: **admin**
Default Password: **admin**



Figure 5-2: Web Login Screen

3. After entering the password, the main screen appears as shown in Figure 5-3.



Figure 5-3: Web Main Screen of Industrial Managed PoE+ Switch

The Switch Menu on the top of the Web page lets you access all the commands and statistics the Industrial Managed PoE+ Switch provides. The Switch Menu always contains one or more buttons, such as **“System”**, **“Switching”**, **“QoS”**, **“Security”**, **“PoE”**, **“Ring”**, **“ONVIF”** and **“Maintenance”**.



Figure 5-4: Switch Menu



Figure 5-5: Industrial Managed PoE+ Switch Menu

Note

If you are not familiar with Switch functions or the related parameter, press **“Help icon”** anytime on the Web page to get the help description.

Now, you can use the Web management interface to continue the Industrial Managed PoE+ Switch management or manage by console interface.

Please refer to the user’s manual for more.

5.2. Saving Configuration

To save all applied changes and set the current configuration as a startup configuration on the Web user interface, the startup-configuration file will be loaded automatically across a system reboot.

1. Click the **Save** icon on the top Switch Menu bar.

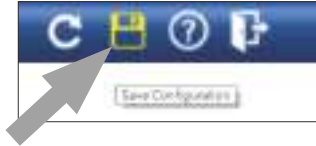

Figure 5-6: Save Config -- Hot Key

2. Press the **"Save Configuration"** button.



3. Or the other way to save the setting is to Click **Maintenance, Save Startup Config.**



Figure 5-7: Save Config -- Maintenance

6. Recovering Back to Default Configuration

To reset the IP address to the default IP address “**192.168.0.100**” and the user password to factory default mode (default password is **admin**), press the hardware-based reset button on the front panel for about 10 seconds. After the device is rebooted, you can log in the management Web interface within the same subnet of 192.168.0.xx and default password. Be noted that all the previous setups will be disappeared after the factory default reset is made.

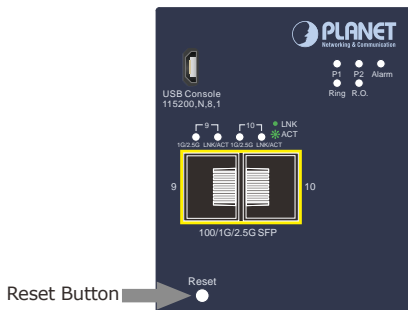

Figure 6-1: IGS-10020HPT-U Reset Button

7. Customer Support

Thank you for purchasing PLANET products. You can browse our online FAQ resource on PLANET web site first to check if it could solve your issue. If you need more support information, please contact PLANET switch support team.

PLANET online FAQs:

<http://www.planet.com.tw/en/support/faq>

Switch support team mail address:

support@planet.com.tw

IGS-10020HPT-U User's Manual:

<https://www.planet.com.tw/en/support/downloads?&method=keyword&keyword=IGS-10020&view=3#list>



(Please select your switch model name from the Product Model drop-down menu.)

Copyright © PLANET Technology Corp. 2023.

Contents are subject to revision without prior notice.

PLANET is a registered trademark of PLANET Technology Corp.

All other trademarks belong to their respective owners.