

# KCM-7311

4MP with D/N, Advanced WDR, SLLS, 3.6x Zoom Lens



- 4 Megapixel
- Day & Night with Superior Low Light Sensitivity
- 3.6x Zoom Lens with f3.3-12mm/F1.4-F2.9, P-Iris, Auto focus
- Advanced WDR
- Event trigger, response and notification

## ► Specifications

### Device

Product Type	Zoom Dome
Maximum Resolution	4MP
Application Environment	Outdoor
Image Sensor	Progressive Scan CMOS
Sensor Size	1/3.2 "
Effective Pixels	2592(H) X 1944(V) (5.04 MP)
Day / Night	Yes
Low Light Sensitivity	Superior
Minimum Illumination	Color: 0.003 lux at F1.4; B/W: 0.002 lux at F1.4
Color to B/W Switch	ISP based switch, configurable
Mechanical IR Cut Filter	Yes
IR LED	No
Electronic Shutter	1/5-1/2000 second (manual mode); 1/5-1/10000 second (auto mode)
Horizontal Resolution (TV Lines)	1422 TVL
S/N Ratio	75 dB

**Lens**

Focal Length	Zoom, f3.3-12mm
Aperture	F1.4-F2.9
Zoom Ratio	3.6x optical zoom
Zoom Application	Camera Installation, Auto Zoom by Event, Manual Operation
Iris	P-Iris
Focus	Auto focus
Lens Mount	Board mount
Horizontal Viewing Angle	77.2° - 22.6°
Viewing Angle Adjustment	Pan: 0°-350°, Tilt: 0°-180°, Rotation: 0°-350°

**PTZ**

Pan, Tilt or Zoom protocol	Visca
----------------------------	-------

**Video**

Compression	H.264 (Baseline), MPEG-4 SP, MJPEG
Maximum Frame Rate vs. Resolution	8 fps at 2032 x 1920 15 fps at 1920 x 1080 30 fps at 1280 x 720 30 fps at 640 x 480
Multi-Streaming	Simultaneous dual streams based on two configurations
Bit Rate	28Kbps - 6Mbps (per stream)
Bit Rate Mode	Constant, Variable
Wide Dynamic Range	Advanced WDR (80 dB)
Image Enhancement	White Balance, Brightness, Saturation, Contrast, Sharpness, Automatic gain control, Flickerless, Defogging
Digital Noise Reduction	2D + 3D DNR
Privacy Mask	4 configurable regions
Text Overlay	Yes
Server-based Analytics	Object Line Counting, People Counting, Face Detection, Object Based Motion Detection, Tamper, Object Line Crossing Detection, Object Enter Area Detection, Missing Object Detection, Unattended Object Detection, Smoke Detection, Heat Map, Dwell Time, Direction Detection, Automatic License Plate Recognition, People Queue Detection, (Require PC-based or standalone IVS or ALPR Server. Contact ACTi support for recommendations on how to maximize analytical accuracy)
Image Orientation	Flip, Mirror

**Audio**

Audio Type	2-way, Line-in, Line-out
Audio Compression	8 kHz, 16 bit encoding, Mono, PCM, G.711

**Network**

Network Protocol & Service	IPv4/v6, TCP, UDP, DHCP, PPPoE, HTTP, HTTPS, DNS, DDNS, NTP, RTP, RTSP, SMTP, FTP, IGMP, ICMP, ARP, Bonjour, UPnP, ToS, SNMP, IEEE 802.1X
Ethernet Port	1 x RJ-45 connector

Security	IP address filtering, HTTPS encryption, Password protected user level, IEEE 802.1X network access control
----------	---

## Event

Event Trigger	Video motion detection (3 regions), External device through digital input,
Event Response	Notify control center, Go to Zoom preset point or preset tour, Change camera settings, Command other devices, E-mail notification with snapshots, Save video or snapshot to local storage, Upload video or snapshot to FTP server, Activate external device through digital output

## System

Watchdog	Support
----------	---------

## Integration

Unified Solution	Fully compatible with ACTi software
Software Development Kit	Yes
ONVIF Compliant	Yes, Profile S
Web Browser	IE 8.0 or newer

## Interface

Audio Interface	Terminal block
Local Storage	MicroSDHC memory card slot (card not included)
Digital Input/Output	2/2
Operating Button	Reset Button

## General

Power Source	DC 12V, PoE Class 3 (IEEE802.3af)
Power Consumption	12.24 W (PoE)
Weight	1050g (2.315lb)
Dimensions	(Ø x H): 151.69mm x 114.9mm (5.97" x 4.52")
Environmental Casing	Weatherproof (IP67), Vandal proof
Mount Type	Surface, Gang Box, Flush, Pendant, Converter for NPT Standard Mounts, Wall Mount, Pole Mount, Corner Mount
Starting Temperature	-10°C ~ 50°C (14°F ~ 122°F) within 30 minutes
Operating Temperature	-30°C ~ 50°C (-22°F ~ 122°F)
Operating Humidity	10% - 85% RH
Approvals	CE, FCC, IP67, UL Listed (UL 60950-1)
Real-time Clock (RTC)	Yes
Warranty	3 Year(s). For extended warranty offering, see <a href="http://www.acti.com/support/warranty">http://www.acti.com/support/warranty</a>

► Photo Indication

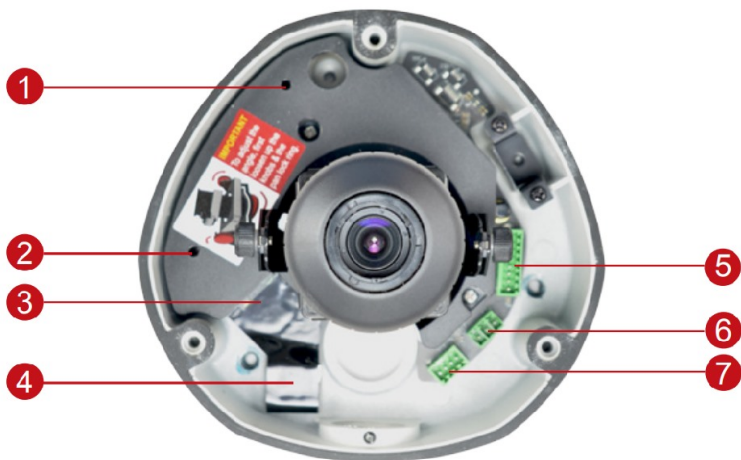

- 1 Reset Button
- 2 Power Button
- 3 Ethernet Port
- 4 MicroSDHC Card Slot
- 5 Digital Input/Output
- 6 DC 12V Power Input
- 7 Audio Input / Output



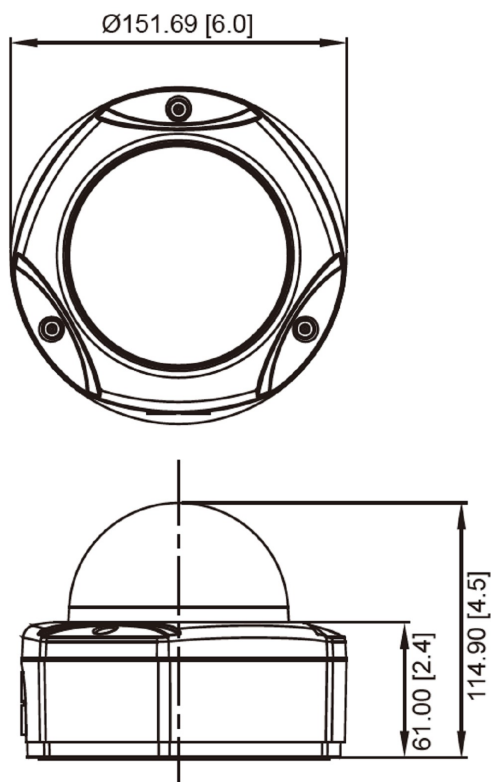









► Dimension Diagram



Unit: mm [inch]

## ► Related Products

### Mounting Accessories - Camera Mount

PMAX-0101		Mount Kit for all Dome Cameras (except Mini Domes)
PMAX-0102		Straight Tube
PMAX-0103		Straight Tube with Bracket
PMAX-0104		Extension Tube
PMAX-0302		Gooseneck with Bracket
PMAX-0303		Gooseneck
PMAX-0354		Heavy Duty Wall Mount for A711, A713
PMAX-0402		Corner Mount
PMAX-0503		Pole Mount (for PMAx-0102, PMAx-0312, PMAx-0313, PMAx-0314, PMAx-0702, PMAx-1106, PMAx-1107), supports 5.25" to 8.5" Poles
PMAX-0505		Pole Mount (for B4x, B41x, E44, E45, E46, E48, E44A, E45A, E46A, E41x, I4x, PMAx-0312, PMAx-0313, PMAx-0314, PMAx-0330), supports 2" to 3" Poles
PMAX-0702		Junction Box for PTZ and Dome Cameras
PMAX-0804		Gang Box Converter for Outdoor Domes, supports Two-Gang Boxes
PMAX-1003		Flush Mount Kit (for D6x, D7x, D8x, E61~E67, E7x [except E78], E81~E88)

**Note:** Some mounting accessories may need additional accessories for installation. Please check [www.acti.com/mountingselector](http://www.acti.com/mountingselector) for more information.

### Dome Covers - Transparent Dome Cover

R701-70006		Transparent Dome Cover Only (for B51, B52, B53, B61~B67, B81~B87, B94~B97, D61~D65, D6xA, D7x, D7xA, D8x, D8xA, E61~E69, E6xA, E71~E77, E7xA, E81~E88, E8xA, Q61, Q81)
------------	---	--

### Network & Storage Peripherals - Data Switch

PPSW-0105		PLANET GS-4210-8P2C 8-Port Gigabit 802.3at Managed PoE Switch (PoE Budget 120W)
PPSW-1101		PLANET GS-4210-24PL4C 24-Port Gigabit 802.3at Managed PoE Switch (PoE Budget 440W)

PPSW-3100



PLANET FGSW-1816HPS 16-Port 802.3at PoE Switch (PoE Budget 220W)

### Extenders - PoE Extender

PPEX-0100



Veracity OUTREACH Max Power over Ethernet (PoE) Extender

### Extenders - PoE over Coaxial Extender Kit

PPOC-0100



Planet LRP-101C-KIT Power over Coax Adapter Kit

### Other Accessories - Camera Part

R707-70002



Rubber base for KCM-7311

R707-70003



Washer for KCM-7311