

Distributed By:

INTEGRATED CONTROLLER KB-100

USER'S MANUAL

Modified on 01.10.2011



Please read the instructions carefully and keep this manual for future reference.

CONTENTS

PRECAUTIONS.....	3
1. Warning	
2. Caution	
3. Maintenance	
MAIN FUNCTIONS AND FEATURES	4
1. Summary	
2. features	
3. Product and Accessories	
4. Changing the Battery	
CONTROLLER BUTTON OVERVIEW	6
PART NAME & FUNCTION	7
CONNECTION.....	8
1. RS-485 / RS-422 Connection	
2. DVR Connection	
3. KB-100 and DVR Mouse Function Use	
4. System Configuration	
START	11
DVR CONTROL.....	11
CONTROLLER MAIN SETUP	12
PTZ CONTROL SETTING	14
JOYSTICK CALIBRATION.....	15
BASIC FUNCTION & CONTROL	16
SPECIFICATIONS	18
DIMENSIONS.....	19

⚡ PRECAUTIONS

To prevent risk or damage while operating the KB-100, you must take note of the following information.

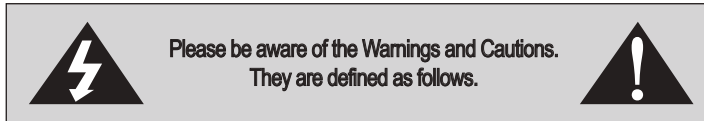

WARNING: Violation of the instructions may cause death or injury.

CAUTION: Violation of the instructions may cause personal injury or product damage.

WARNING

- Before using the product, please be sure to read the user manual.
- Install this product in a safe place that is free from external vibration.
- Do not place conductive materials (screwdriver, coin, iron, etc) or water near the product.
- Use only the indicated power supply (DC12V).
- Do not use this product near flammable substances.
- Do not touch electrical parts with wet hands.
- When the product is not operating normally, contact your seller or service center.
- Never disassemble the equipment. The Warrantor is not responsible for problems caused by disassembly done by the user.

CAUTION

- This device is recommended for indoor use only. It should not be used outdoor, where it is exposed to rain or moisture.
- Dropping the product in water may cause severe damage to the product.
- Do not use the product in humid, dusty, or sooty environments.
- Do not leave the device too hot or too cold.
- Always keep the operating temperature between 0°C and 45°C (32°F and 113°F).
- Do not place this product under direct sunlight. It will cause discoloration or damage.
- Do not subject this product to severe shock.
- Unplug the power when there is a thunder or lightning storm. The storm may cause fire or damage.

MAINTENANCE

- If the controller needs cleaning, turn off the power and wipe the surface with a soft cloth.
- Prevent contact with alcohol, benzene, and other chemicals. They may cause the surface to change color.

MAIN FUNCTIONS AND FEATURES

Summary

The KB-100 is a System Integrated Controller that can control up to 255 units, such as DVR, PTZ dome cameras, multiplexer, receiver, etc. It offers excellent system compatibility with support for multiple protocols. An array of buttons, easy connection, and fine control make the KB-100 a necessity in the CCTV market.

Features

- Elegant and Ergonomic Design
- Controls Up to 255 DVRs and/or PTZ Cameras
- Superior System Compatibility: Multiple Protocols Supported
- 3D Joystick Control of On-Screen Display Icon Menu
- RS485 and RS422 Compatibility
- Programmable User Interface: Preset, Tour, Pattern, Scan, Auto Pan
- User Password Support
- Battery Operation
- Low Power Consumption Design
- USB Mouse Control for DVR

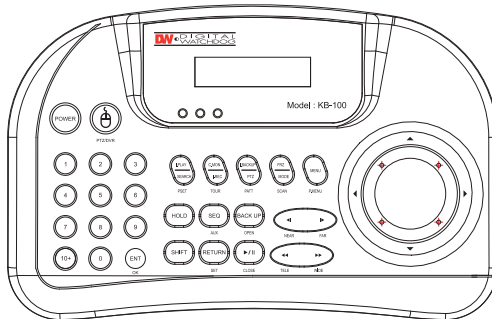

CONTROLLER & ACCESSORIES

Product and Accessories



KB-100
(Controller)

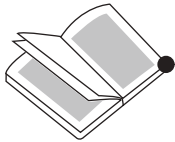

Manual



Communication
Connector

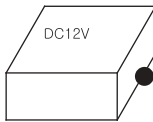

Adaptor
(Optional)

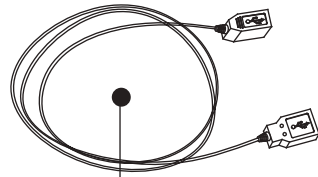

USB Cable

Changing the Battery

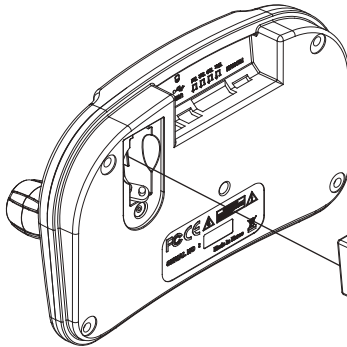







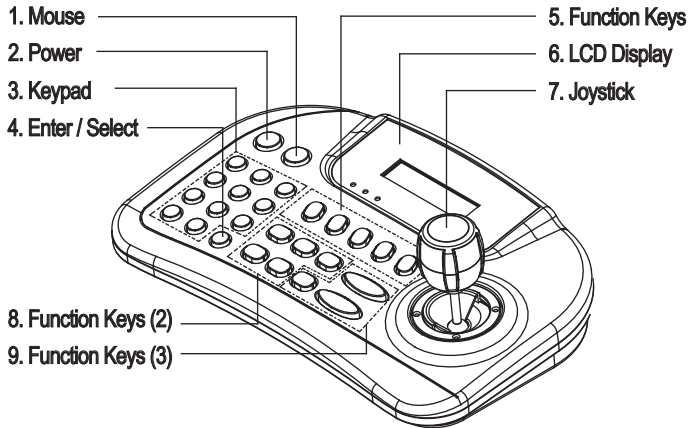

DC9V Battery (Optional)

Battery Cover



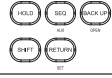
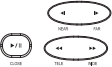

CONTROLLER BUTTON OVERVIEW

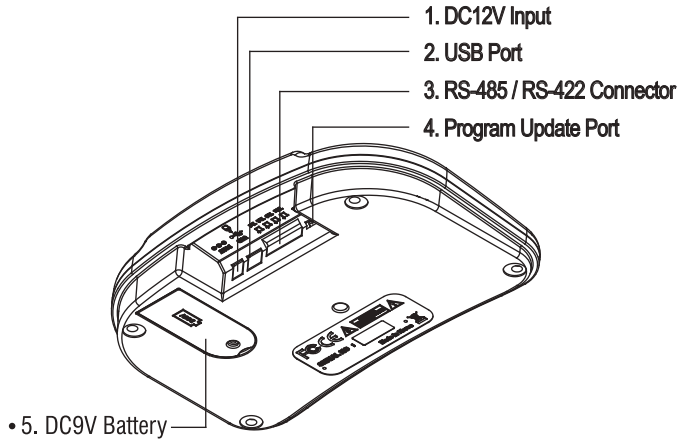

NO.	Button	Action	Function
1	MOUSE 	Long Key Short Key	Switch to Mouse control mode Switch to DVR or Camera control mode
2	POWER 	Long Key Short Key	Power off Power on
3	NUMBERS 	Short Key	Enter the numbers to select a camera channel or setup DVR / Camera ID * To select channel No.16, press  + 
4	ENTER 	Long Key Short Key	Confirm DVR / Camera ID Enter into the selected setup menu or Select setup value
5	Function keys(1) 	Long Key Short Key Short Key	[In DVR Mode] Instant Reverse Playback, Call Monitor, Instant Backup, Freeze Search, Instant Recording, PTZ, Mode, Go to DVR setup menu [In Camera Mode] Preset, Tour, Pattern, Scan, Go to PTZ setup menu
6	LCD Display		Shows the number entered, system state and running features
7	Joystick 	UP / DOWN LEFT / LIGHT	Navigate DVR setup menu; switch channel display or mode; control PTZ camera
8	Function keys(2) 	Short Key	[In DVR Mode] Hold, Sequence, Backup, Return *SHIFT: Optional Functions are used in. [In Camera Mode] AUX, OPEN, SET
9	Function keys(3) 	Short Key	[In DVR Mode] Control Playback mode [In Camera Mode] CLOSE, NEAR, FAR, TELE, WIDE

PART NAME & FUNCTION



No.	Item	Function
1	 DC 12V Input	Power input (DC 12V, 140mA)
2	 USB PORT	USB connecting terminal
3	 TRx Tx3 Tx2 Tx1 RS-485 / RS-422	DVR, Camera, Mux ..etc connecting terminal
4	Program Update Port	Program update port
5	 DC9V Battery	DC9V battery part

Use the joystick to switch channel display or change display mode.



Switching Channel Display

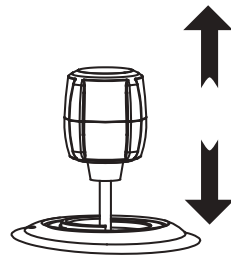

Change Display Mode

CONNECTION

RS-485 / RS-422 Connection

Using an RS-485/RS-422 cable, connect an external device to the RS-485/RS-422 Terminal Block of the KB-100.

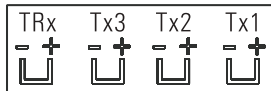

When connecting, make sure the polarity (+, -) is not changed.
Remember to check to see if the device you wish to control supports RS-485 / RS-422.

DVR Connection

Connect the USB cable to the desired Digital Video Recorder.

Press the Mouse  button.

 If you briefly press the button, the keyboard alternates from DVR to Camera Control Mode.

 If you press and hold, mouse function is activated through the USB Port.

 If you press, the following information will be displayed on the LCD Display.

DVR WKEY 9.6K
ID : 001

Transfer speed is 9600bps.
Control ID is 001.
Display ID is DVR ID.

If you want to control another DVR ID, push Number Key and ENT. ID will change.

(Example: Press and hold 3 + .)



* Constant value for each COMMAND has been set. (This function is only available after you setup a value for each command. See page 11.)

KB-100 and DVR Mouse Function Use

DVR WKRY 9.6
ID : 001 MOUSE

Press and hold the Mouse  button to start the feature.
Mouse function will begin when the word "MOUSE" begins flashing on the LCD screen.

Make sure the following steps are complete before using KB-100 on your DVR.

1. DVR must be PC compatible. A device driver is required. Review your DVR's manual for further information.
2. Power ON the DVR.
3. Power ON the KB-100.
4. Setup the Mouse Speed in the Main Setup. (KB-100 2 + )
5. Connect the KB-100 and the DVR.
6. If you press and hold the Mouse  button, you will see the word "MOUSE" flashing on the screen.
7. Check to see if there is a mouse pointer on the screen.
8. Use the joystick to control the mouse. Use the L/R buttons as the mouse buttons.



USE 'L', 'R' button of mouse



Joystick

Use mouse-pointer moving

SYSTEM CONFIGURATION

Single System Configuration

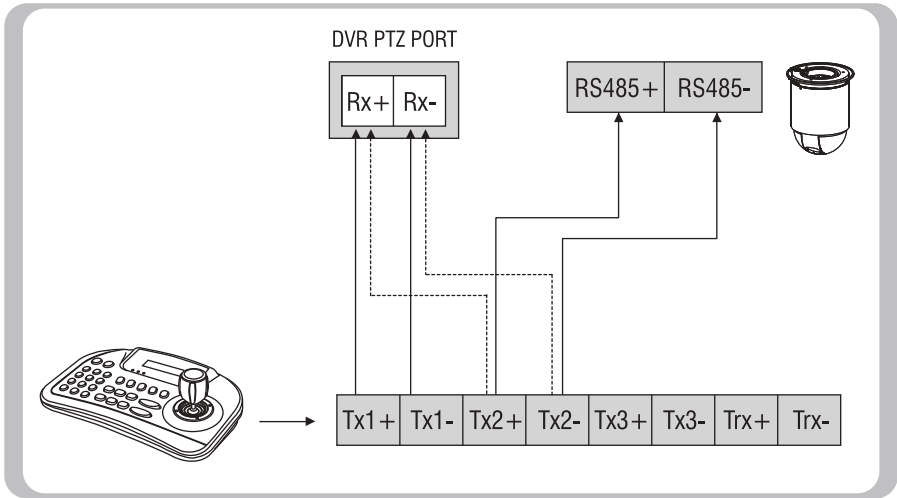

Multiple System Configuration Using Multiple DVRs.

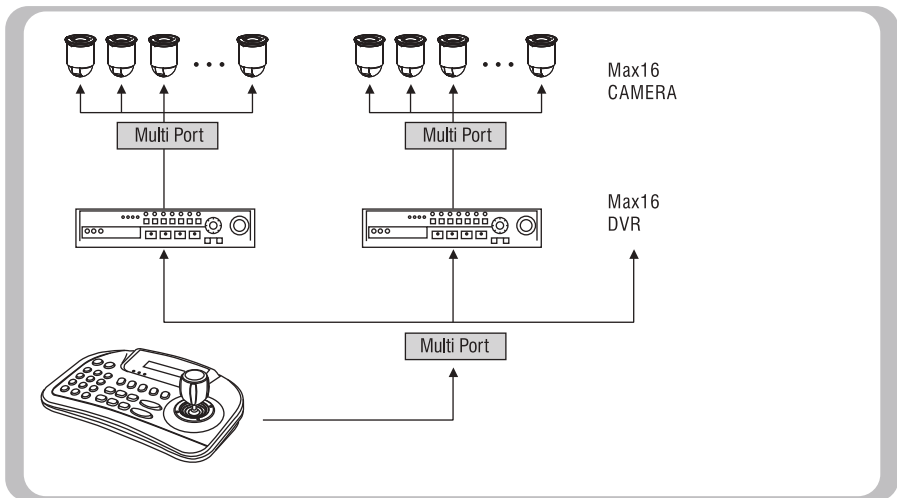

SYSTEM CONFIGURATION

Single System Configuration

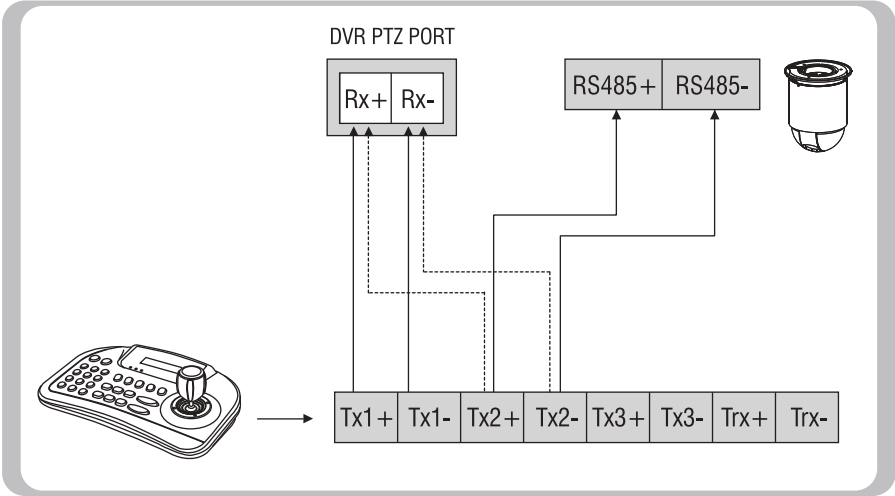

Multiple System Configuration to Control Multiple Cameras Directly

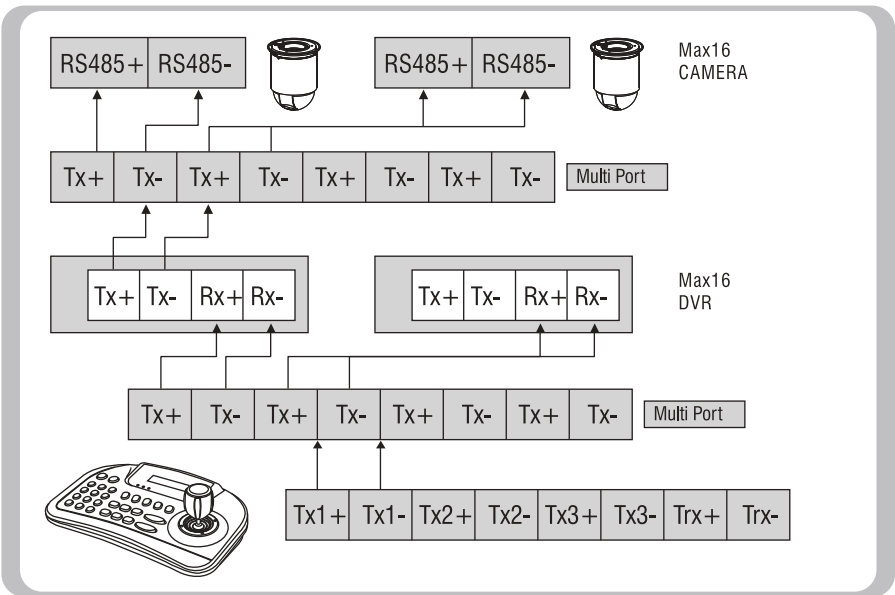

START

Precautions Before Start

- Before installing the keyboard, be sure to turn the power off.
- A strong shock or vibration may cause malfunction of the product.
- Avoid installing in locations near strong magnetic and radio waves, such as radio, TV, or wireless devices.
- During or after installation, make sure the area around the device is tidy.
- During installation, make sure the product is flat on the floor, maintain proper temperature, and keep the product at least 15cm (5.9in) away from the wall.

Operating Temperature: 0°C ~ 45°C (32°F ~ 113°F).

Storage Temperature: -10°C ~ 60°C (14°F ~ 140°F).







Input Voltage: DC12V, 140mA

DC9V (Alkaline Batteries) - Purchase Separately

Power Consumption: 20mA (LCD OFF)

DVR CONTROL

In order to control the DVR, first setup the SITE ID, baud rate as "9600", and the Keyboard as "KB-100" on the DVR.

1. Select the DVR mode by pressing Mouse  button.
2. Enter the DVR ID using the number keypad on the keyboard and press and hold the ENTER  button.
3. Press MENU to display the DVR menu setup and RETURN  to exit the menu setup.
4. Press FRZ/MODE  to change the camera display.
5. Press and hold the ENTER  and SHIFT  buttons at the same time for 10 seconds to select another DVR.

CONTROLLER MAIN SETUP

After connecting the keyboard to power source, press the POWER  button. The following displays will appear on the LCD screen.

Main Menu Setup

Press [2] button and press and hold RETURN  button. The Main setup menu will appear. The default password is [0000].

Move the joystick left and right to go through the main menu settings. Menu settings can be stored or cancelled at the Main Menu No 13.

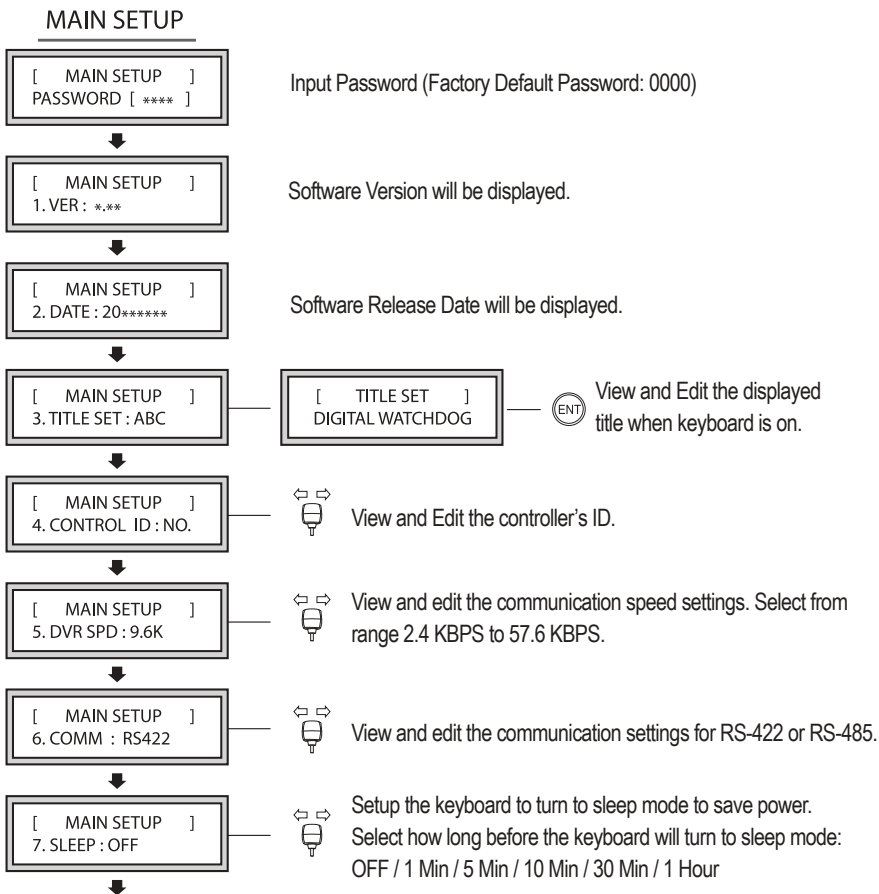

CONTROLLER MAIN SETUP

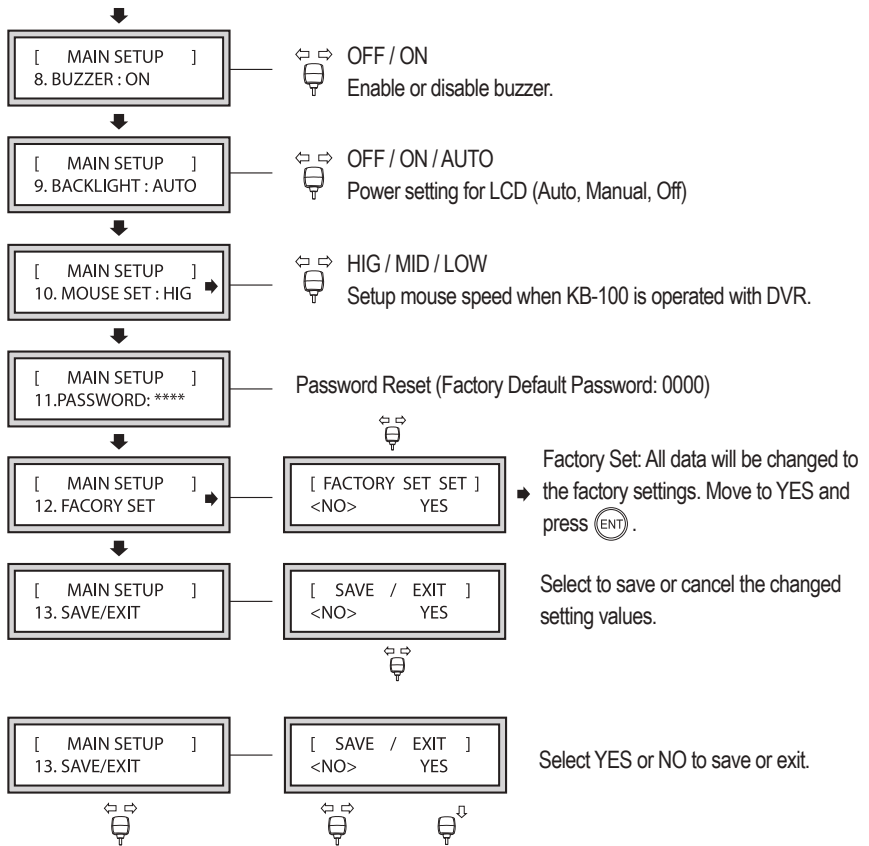

After factory set, the Tx LED on the LCD screen will be flashing, and when it is completed flashing will stop.
 After factory set, the joystick will reset the settings in the joystick calibration mode.
 See page 15 for more information.

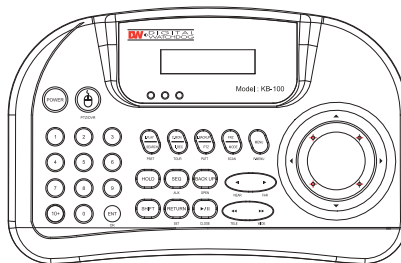

PTZ CONTROL SETTING

Press [1] button and press and hold  button. The default password is [0000].
The PTZ Setup Menu will appear.

PTZ SETUP

[PTZ SETUP 1]
PASSWORD [****]

Input Password (Factory Default Password: 0000)

[PTZ SETUP 1]
1. ADDRESS : 001



Input camera address by using joystick.
(1-255) + 

[PTZ SETUP 1]
2. MODEL : PEL



Use joystick to find the camera mode you want to control.
If your camera's model is not on the list, please select PEL-D.

[PTZ SETUP 1]
3. PROTOCOL : PEL-D



Set the protocol.

[PTZ SETUP 1]
4. BAUDRATE : 2.4 K



Set the baudrate: 2.4 KBPS - 57.6 KBPS.

[PTZ SETUP 1]
5. PARITY : NONE



Set the parity: NONE / EVEN / ODD.

[PTZ SETUP 1]
6. PROP : ON



Set the camera speed (PROP).
Slow PTZ = ON and Fast PTZ = OFF

[PTZ SETUP 1]
7. SAVE



Save changes.

[PTZ SETUP 1]
8. EXIT



Exit PTZ menu.

JOYSTICK CALIBRATION

View and edit the joystick's movement.

Calibration method: Press [3] button and press and hold  button.

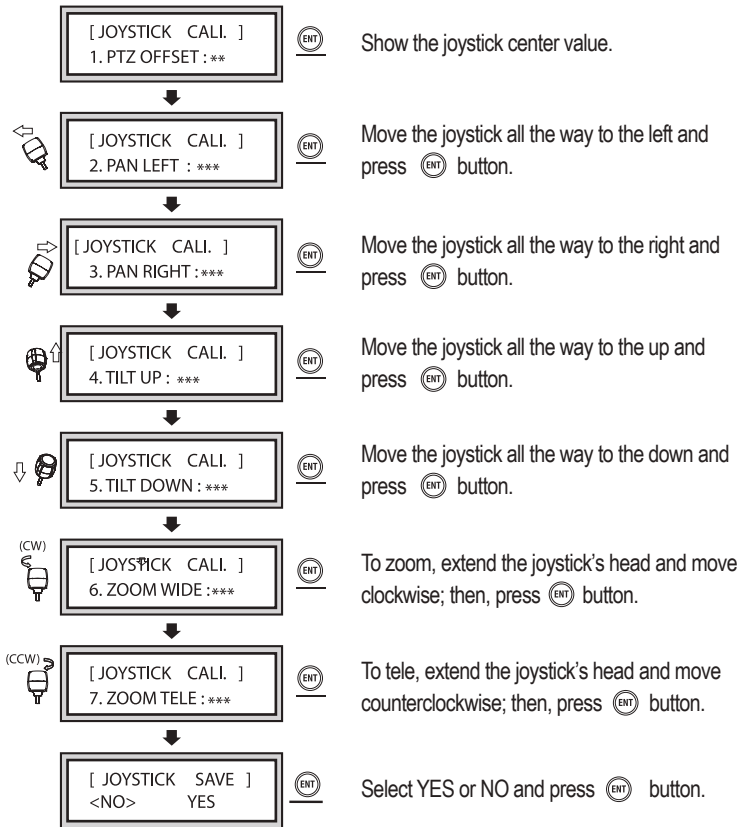

❑ BASIC FUNCTION & CONTROL

These features are only available for your PTZ camera. Please consult your camera manual for more information.

1. PRESET



Use can set the camera to a desired preset location.



1 + PSET

2 + PSET

3 + PSET

PRESET setting : PRESET NO. +  3sec
 PRESET operating : PRESET NO. +  1sec

1. TOUR

When tour function runs, camera moves from the preset assigned as the first point to the preset assigned as the last point in sequence. The camera will stay at each point for the time set on the dwell time in Tour Edit and move to the next point.

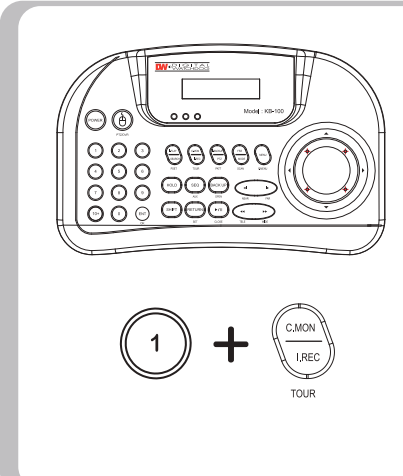



Consecutively operating

1 + PSET

2 + PSET

3 + PSET

TOUR setting : TOUR NO. +  3sec
 TOUR operating : TOUR NO. +  1sec

☐ BASIC FUNCTION & CONTROL

1. PATTERN

Camera memorizes the path made by the joystick of the controller for an assigned time and revives the path exactly as it memorized.

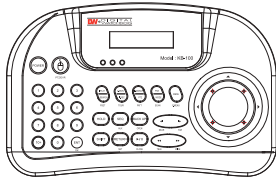

Consecutively operating

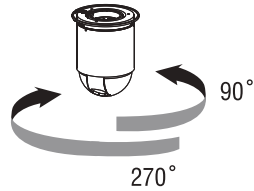

To set PATTERN: PATTERN NO. +  3 sec

To run PATTERN: PATTERN NO. +  1sec

1. SCAN

Camera moves between 2 points if there is no PTZ command after passing the assigned dwell time.

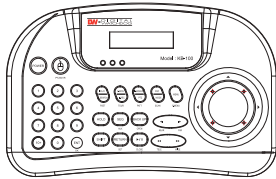

Consecutively operating

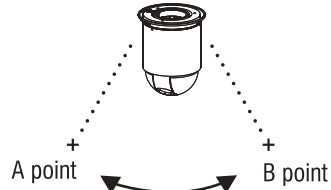

To set SCAN: SCAN NO. +  3 sec

To run SCAN: SCAN NO. +  1sec

1. AUTO PAN

Camera moves between 2 preset positions.

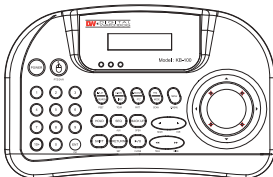

Consecutively operating

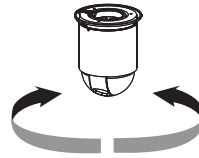

■ SPECIFICATIONS

MODEL	KB-100
Keyboard communication	Pan/Tilt interface : RS-485/422
	Interface : RS-485/422
	Pan/Tilt operating distance : 4700FT (1029m) on 24 AWG wire
	Protocol : Multiple (Pelco-D, Pelco-P, Etc.) (Baud rate selectable)
Connector Type Data	TERMINAL BLOCK(8p)
Keyboard button	Rubber button
	Numeric keypad and camera function key
Joystick	3-Axis Rotation, Variable speed with zoom
power	12V DC or 9V battery (battery)
Power consumption	Max.140mA
LCD Display	Graphic display 16 character x 2 lines
Operating Temp./ Humidity	0°C - 45°C (32°F - 113°F) / 10-70% Non-Condensing
Size, Weight	280(W) x 180(D) x 100(H) / Net : 0.74kg, 1.63 lbs / Gross : 1.28kg, 2.8lbs

** The design and specification are subject to improvement changes without prior notice.

MEMO

MEMO