

# Q75

## 20MP Outdoor Multi-Imager 180 Degree Dome with D/N, Adaptive IR, Advanced WDR, SLLS, 4 Fixed lenses



- 20 Megapixel
- Day & Night with Superior Low Light Sensitivity and Adaptive IR LED
- Fixed Lens with f5.5mm/F1.8
- Advanced WDR
- H.265 Compression
- Super wide angle

### ► Specifications

#### Device

Product Type	Multi-Imager 180 Degree Dome
Maximum Resolution	20MP
Application Environment	Outdoor
Description	20MP Outdoor Multi-Imager Panoramic Dome with D/N, Adaptive IR, Extreme WDR, SLLS, 4 Fixed lenses, 4pcs 5MP sensors
Image Sensor	Progressive Scan CMOS
Sensor Size	1/1.8 "
Effective Pixels	3096(H) X 2080(V) x 4 (6.44 MP)
Day / Night	Yes
Low Light Sensitivity	Superior
Minimum Illumination	Color: 0.003 lux; B/W: 0 lux (IR LED on)
Mechanical IR Cut Filter	Yes
IR LED	Adaptive IR LED (850 nm)
IR Working Distance	30m
S/N Ratio	75 dB

**Lens**

Number of Lenses	4 Lenses
Focal Length	Fixed focal, f5.5mm
Aperture	F1.8
Iris	Fixed iris
Horizontal Viewing Angle	180°
Vertical Viewing Angle	47°
Viewing Angle Adjustment	Pan: 0°-355°, Tilt: 0°-90°

**Video**

Compression	H.265, H.264
Maximum Frame Rate vs. Resolution	30 fps at 2592 x 1944 30 fps at 2048 x 1536 30 fps at 1920 x 1080 30 fps at 1280 x 720
Multi-Streaming	Simultaneous triple streams
Bit Rate Mode	Constant, Variable
Wide Dynamic Range	Advanced WDR (100 dB)
Image Enhancement	White Balance, Brightness, Contrast, Saturation, Sharpness, Backlight compensation (BLC)
Privacy Mask	Yes
Built-in Analytics	Object Based Motion Detection, Tampering Detection
Image Orientation	Mirror, Flip

**Audio**

Audio Type	2-way, Line-in, Line-out
------------	--------------------------

**Network**

Ethernet Port	1 x Ethernet (1000 Base-T), RJ-45 connector
---------------	---

**Event**

Event Trigger	Video motion detection
---------------	------------------------

**System**

Watchdog	Support
----------	---------

**Integration**

ONVIF Compliant	Yes, Profile S, Profile Q, Profile G, Profile T
-----------------	---

**Interface**

Local Storage	MicroSDHC memory card slot (card not included)
Digital Input/Output	1/1
Operating Button	Reset Button

**General**

Power Source	DC 12V, AC 24V, High PoE (IEEE802.3at)
Power Consumption	25.5 W (PoE)

Weight	2500g (5.51lb)
Dimensions	(Ø x H): 196mm x 188.4mm (7.72" x 7.42")
Environmental Casing	Weatherproof (IP66), Vandal proof (IK10)
Corrosion Protection	Optional for project request. Chassis corrosion resistance at the seashore approximately 2-3 years.
Mount Type	Surface, Pendant, Wall Mount
Starting Temperature	-20°C ~ 50°C (-4°F ~ 122°F)
Operating Temperature	-40°C ~ 50°C (-40°F ~ 122°F)
Approvals	CE, FCC, IP66, IK10

### ► Photo Indication



- 1 Digital Output
- 2 Digital Input
- 3 Power Connector
- 4 Audio Output Jack
- 5 Reset Button
- 6 Audio Input Jack
- 7 Ethernet Port
- 8 Memory Card Slot



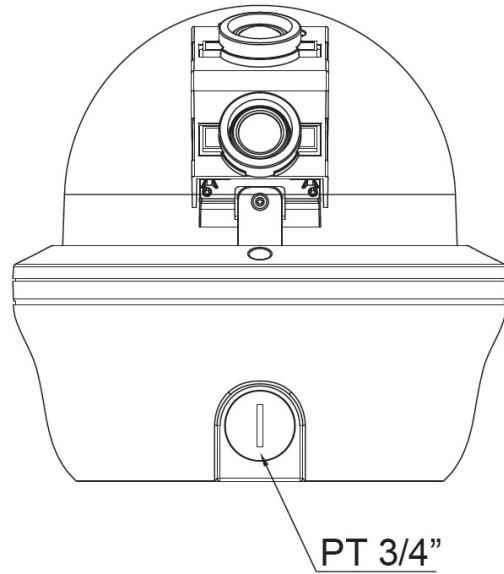
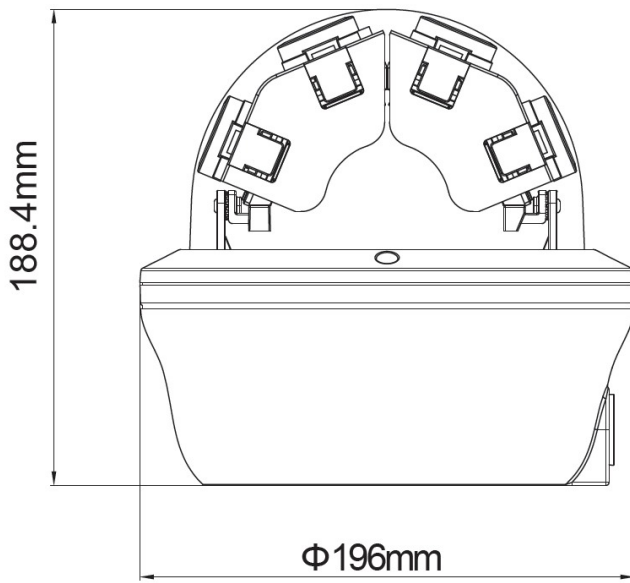





### ► Dimension Diagram



Unit: mm [inch]

## ▶ Related Products

### Mounting Accessories - Camera Mount



PMAX-0104		Extension Tube
PMAX-0125		Straight Tube with Converter Ring (for Q75)
PMAX-0126		Straight Tube with Bracket and Converter Ring (for Q75)
PMAX-0346		Heavy Duty Wall Mount with Converter Ring (for Q75, A950, A951, A952, A956)
PMAX-0402		Corner Mount
PMAX-0503		Pole Mount (for PMA-0102, PMA-0312, PMA-0313, PMA-0314, PMA-0702, PMA-1106, PMA-1107), supports 5.25" to 8.5" Poles
PMAX-0702		Junction Box for PTZ and Dome Cameras
PMAX-0807		Gangbox Converter (for PMA-0102, PMA-0312, PMA-0313, PMA-0314, PMA-0321), supports Two-Gang Boxes

**Note:** Some mounting accessories may need additional accessories for installation. Please check [www.acti.com/mountingselector](http://www.acti.com/mountingselector) for more information.

### Power Supply Accessories - Power Adapter

PPBX-0015		Power Adapter AC 100~240V (12V/2A Output), with universal connectors for R21CF-xx
-----------	---	---

### Power Supply Accessories - PoE Injector

PPOE-0101		High PoE Injector IEEE 802.3at compliant, AC 100~240V, with universal connectors (for A416, A418, B913, B923, B934, Q450, Q75, VMGB-400, VMGB-603, VMGB-604, Z36, Z37, Z71, Z710, Z952)
PPOE-0106		High PoE Injector IEEE 802.3at compliant, AC 100~240V, with universal connectors (for A416, A418, B913, B923, B934, Q450, Q75, VMGB-60X, Z37, Z71, Z952)

### Audio Devices - Microphone

PMIC-0100		Active Microphone Omnidirectional for all Cameras with Line-in Audio
-----------	---	--

