



Intercom Camera Hardware Manual

Q970

2022/03/23



Table of Contents

Precautions	3
<hr/>	
Safety Instructions	5
Introduction	6
<hr/>	
The List of Models	6
Package Contents.....	7
Physical Description	8
Installing the Camera	9
<hr/>	
Step 1: Prepare for Installation.....	9
Step 2: Mount the Camera	9
Step 3: Connect the Camera.....	9
Step 4: Access the Camera Live View.....	10
Cable Connections	11
<hr/>	
Connecting a Power Adapter (Optional)	11
Connecting DI/DO Devices (Optional).....	12
Connecting Serial Devices (Optional).....	13
Other Accessories	14
<hr/>	
How to Install / Remove the Memory Card	14
How to Remove the Memory Card.....	14
Accessing the Camera	15
<hr/>	
Configure the IP Addresses	15
Access the Camera.....	19

Precautions

Read these instructions

Read all the safety and operating instructions before using this product.

Heed all warnings

Adhere to all the warnings on the product and in the instruction manual. Failure to follow the safety instructions given may directly endanger people, cause damage to the system or to other equipment.

Servicing

Do not attempt to service this product yourself as opening or removing covers may expose you to dangerous voltage or other hazards. Refer all servicing to qualified service personnel.

Trademarks

ACTi and ACTi logo are registered trademarks of ACTi Corporation. All other names and products used in this manual are registered trademarks of their respective companies.

Liability

Every reasonable care has been taken during the writing of this manual. Please inform your local office if you find any inaccuracies or omissions. ACTi will not be held responsible for any typographical or technical errors and reserves the right to make changes to the product and manuals without prior notice.

Federal Communications Commission Statement



This equipment has been tested and found to comply with the limits for a class B digital device, pursuant to Part 15 of the FCC Rules. These limits are designed to provide reasonable protection against harmful interference in a residential installation. This equipment generates, uses, and can radiate radio frequency energy and, if not installed and used in accordance with the instructions, may cause harmful interference to radio communications. However, there is no guarantee that interference will not occur in a particular installation. If this equipment does cause harmful interference to radio or television reception, which can be determined by turning the equipment off and on, the user is encouraged to try to correct the interference by one or more of the following measures:

- Reorient or relocate the receiving antenna.
- Increase the separation between the equipment and receiver.
- Connect the equipment into an outlet on a circuit different from that to which the receiver is connected.
- Consult the dealer or an experienced radio/TV technician for help.

Warning: Changes or modifications to the equipment that are not expressly approved by the responsible party for compliance could void the user's authority to operate the equipment.

European Community Compliance Statement



This product has been tested and found to comply with the limits for Class B Information Technology Equipment according to European Standard EN 55022 and EN 55024. In a domestic environment, this product may cause radio interference in which cause the user may be required to take adequate measures.

Safety Instructions

Cleaning

Disconnect this product from the power supply before cleaning.

Accessories and Repair Parts

Use only the accessories and repair parts recommended by the manufacturer. Using other attachments not recommended by the manufacturer may cause hazards.

Installation

The device front panel is waterproof, however, installers must ensure that water will not penetrate through any gap on the surface wall which may leak through to the cable connections or the main board.

The device is designed to be flush mounted on the wall. Surface mounting the device or mounting it in other ways may affect its waterproof capability.

Install other devices (such as PoE injector, alarm, etc.) that will be used with the camera in a dry place protected from weather.

Servicing

Do not attempt to service this product yourself. Refer all servicing to qualified service personnel.

Damage Requiring service

Disconnect this product from the power supply immediately and refer servicing to qualified service personnel under the following conditions.

- 1) When the power-supply cord or plug is damaged
- 2) If liquid has been spilled, or objects have fallen into the product.
- 3) If the inner parts of product have been directly exposed to rain or water.
- 4) If the product does not operate normally even by following the operating instructions in this manual. Adjust only those controls that are covered by the instruction manual, as improper adjustment of other controls may result in damage, and will often require extensive work by a qualified technician to restore the product to its normal operation.

Safety Check

Upon completion of any service or repairs to this product, ask the service technician to perform safety checks to determine if the product is in proper operating condition.

Introduction







The List of Models

This hardware manual contains the following models:

Q970		2MP, Intercom, Basic WDR, Superior Low Light Sensitivity
------	---	--

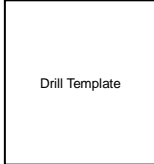
Package Contents

Check if the camera package comes with the following items.

Camera	Screws and Plugs	Drill Template
		
10-Pin Terminal Block	6-Pin Terminal Block	Quick Installation Guide & Warranty Card
		

Physical Description

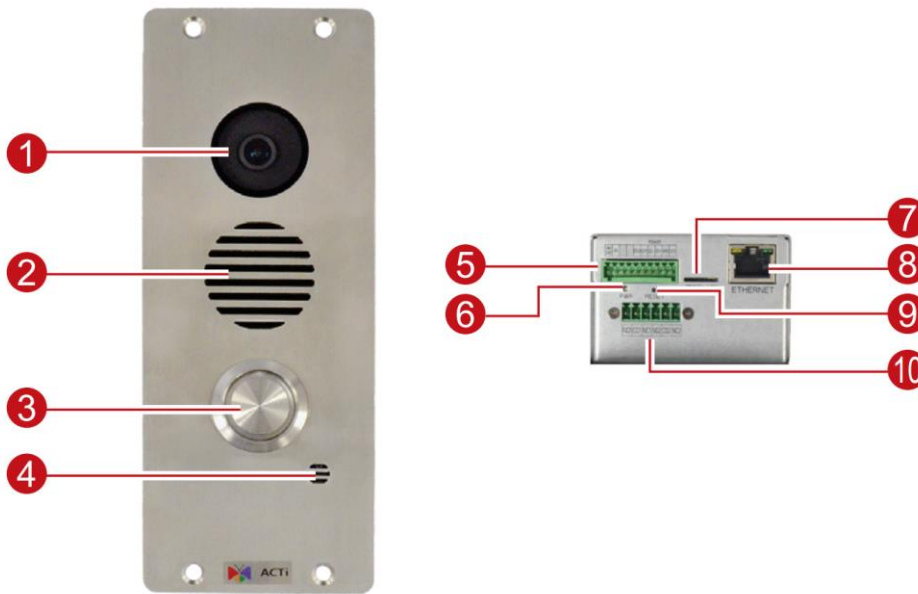

Item		Description
1	Lens	Provides a wide viewing angle
2	Speaker	The built-in speaker allows the user to hear the person on the receiving end.
3	Push Button	Functions as the emergency button. Push to notify and speak to personnel in charge.
4	Built-in Microphone	The built-in microphone allows the user to speak to the person on the receiving end.
5	Audio Input / Digital Input / Serial Connector	Connects external input devices such as audio and digital input devices. Serial devices that use RS-485 protocol can also be connected here. See Cable Connections on page 11.
6	Power LED	Lights red when the camera is powered up.
7	Memory Card Slot	Insert a memory card (not included) into the slot for local recording purposes. See How to Install / Remove the Memory Card on page 14 for more information. NOTE: Supports only microSDHC and microSDXC cards.
8	Ethernet Port	Connects to a network using an Ethernet cable.
9	Reset Button	Restores the factory default settings of the camera. To reset the camera, while the power is on, press and hold the Reset Button for at least 5 seconds or until the Power LED goes off.
10	Digital Output	Connects to digital output devices, such as an alarm trigger, etc. See Cable Connections on page 11 for information.

Installing the Camera

The intercom camera is designed to be directly flush mounted on the wall. The front panel is visible and will be aligned on the surface of the wall. This installation requires access to the back of the surface.

Step 1: Prepare for Installation

1. Attach the bundled drill template sticker on the target installation surface.
2. Drill the hole where the camera body will be mounted. Note that the connectors are on the bottom side of the camera; make sure that side can be accessed from the back of the surface.
3. Drill the screw holes, as needed.
4. Remove the drill template.

Step 2: Mount the Camera

1. Mount the camera body through the hole.
2. Attach the four (4) screws to secure the camera on the surface.

NOTE: The device front panel is waterproof. However, you must ensure to seal and protect water from entering through any gap on the surface wall which may flow to the cable connections on the bottom of the camera.

Step 3: Connect the Camera

1. Connect the other end of the network cable from the camera to the network. Connect all other devices, if any.
2. Connect the other end to a switch or injector. Then, connect the switch or injector to a network or PC and a power source. See Power-over-Ethernet (PoE) example connection diagram below.

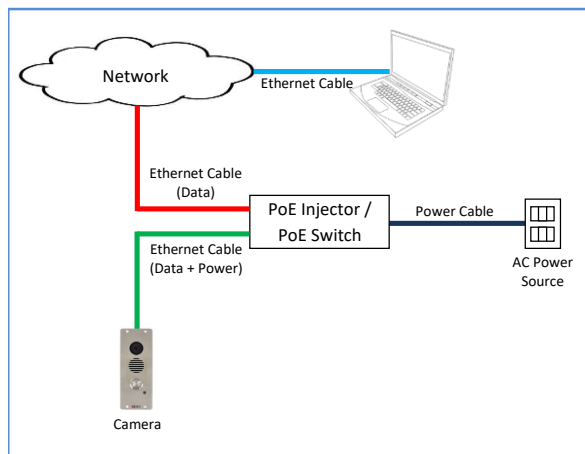

In case of using a non-PoE switch, power up the camera using a power adapter (not supplied). See [Connecting a Power Adapter \(Optional\)](#) on page 11 for more information.

3. As needed, connect and power up other devices, such as digital input/output, audio, or serial device. See [Cable Connections](#) on page 11 for more information on connecting other devices.

Step 4: Access the Camera Live View

See [Accessing the Camera](#) on page 15 for more information.

Cable Connections

This section describes the procedures in preparing the external devices that you can connect to the camera. The camera supports DC12V power input, Digital Input / Output, Serial devices, and external Audio Input device using the bundled terminal blocks. The use of these devices, however, is optional.

Connecting a Power Adapter (Optional)

The camera can be powered by a Power over Ethernet (PoE) switch that is IEEE802.3af compliant. In case of using a non-PoE switch or your PoE switch has limited power supply, you can purchase a power adapter and directly connect the camera to a power outlet. The power adapter must be connected to the supplied terminal block before use.

Map the pins of the power adapter to the terminal block pins. Press and hold the orange tab as you insert the wire through the pin slot, then release the orange tab to secure the wire. Then connect the terminal block to the camera.

Take note that a standard power adapter cable has two (2) different wires:

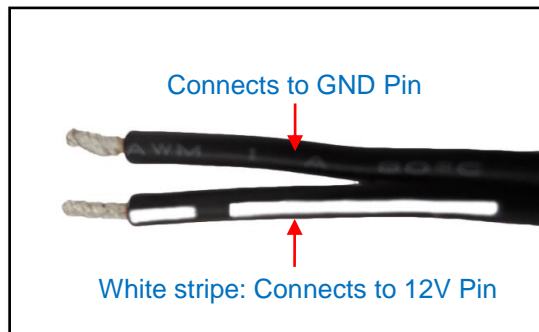

NOTE: The power adapter is not bundled in the package.

Connecting DI/DO Devices (Optional)

Depending on your needs, you may connect digital input/output devices, such as alarm to the camera.

Check the device documentation for the pin mapping specifications. Map the pins of the device to the supplied terminal block pins accordingly. Then connect the terminal block to the camera.

Below is a diagram on how the Digital Output of the camera work.

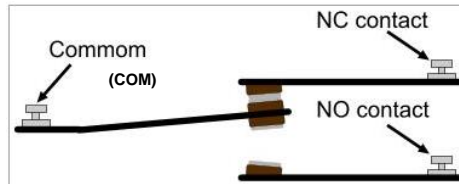

Some devices may not have Normal Close and Normal Open switches, thus only have DC12V and GND wire connectors. In this case, map the wires according to the diagram below.

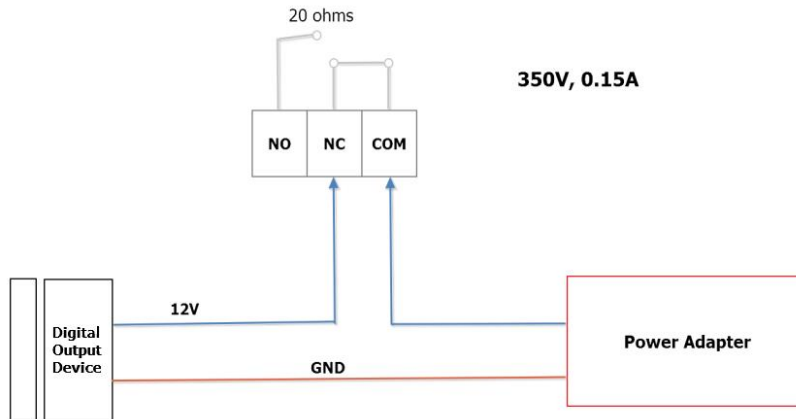

DI	Connection design		TTL-compatible logic levels
	Voltage	To trigger (low)	Logic level 0: 0V ~ 0.4V
		Normal (high)	Logic level 1: 3.1V ~ 30V
	Current		10mA ~ 100mA
DO	Connection design		Form C Solid-State Relay <ul style="list-style-type: none"> Isolation test voltage 3750 VRMS Typical RON 20 DC or peak AC load voltage 350 V Continuous DC load current (form C operation) 15 mA Output power dissipation (continuous) 600 mW
	Voltage accepted		350V AC/DC, 0.15A

It is advised to use an external power for digital output. Configure the Event List on the Web Configurator to setup the digital input/output device trigger and response. See Firmware User Manual for information.

Connecting Serial Devices (Optional)

Depending on your needs, you may connect a serial device to the camera using the RS-485 protocol.

To connect a serial device, map the pins. Press and hold the orange tab as you insert the wire through the pin slot, then release the orange tab to secure the wire. Then connect the terminal block to the camera.

Via RS-485 Connection

Pin Label	Camera	Serial Device
GND	GROUND PIN	
D-	TX -	DATA -
D+	TX +	DATA +

NOTE: The pins of the serial device may be labeled differently depending on the location or country where the device is purchased. For example, some devices may have RS-485 **DATA+** pins labeled as “TX+”, “RX+”, “A” or “485+”, etc. Refer to the device documentation or contact the manufacturer to verify the corresponding pin labels and ensure proper wiring connection.



CAUTION: Incorrect wiring may cause damage to the connected devices.

DISCLAIMER: ACTi will not be responsible for any damage caused by improper wiring.

Other Accessories

How to Install / Remove the Memory Card

The camera supports local video recording to a memory card (not supplied).

NOTE: Supports microSDHC and microSDXC cards.

Install the memory card, with the metallic contacts facing the front of the camera, into the memory card slot until it clicks into place.

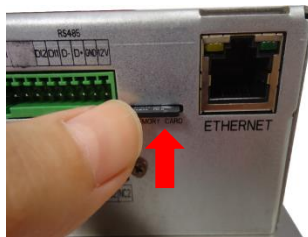

Once inserted, make sure to access the camera Web Configurator and “mount” the card to prepare the card for local recording. Refer to the camera Firmware User’s Manual for more information.

How to Remove the Memory Card

In case there is a need to remove the card, make sure to access the camera Web Configurator to safely “unmount” the card first (see the camera Firmware User’s Manual for more information). Once unmounted from the firmware, push the card to eject it from the slot.

Accessing the Camera

Configure the IP Addresses

In order to be able to communicate with the camera from your PC, both the camera and the PC have to be within the same network segment. In most cases, it means that they both should have very similar IP addresses, where only the last number of the IP address is different from each other. There are 2 different approaches to IP Address management in Local Area Networks – by DHCP Server or Manually.

Using DHCP server to assign IP addresses

If you have connected the computer and the camera into the network that has a DHCP server running, then you do not need to configure the IP addresses at all – both the camera and the PC would request a unique IP address from the DHCP server automatically. In such case, the camera will immediately be ready for the access from the PC. The user, however, might not know the IP address of the camera yet. It is necessary to know the IP address of the camera in order to access it using a Web browser.

The quickest way to discover the cameras in the network is to use the simplest network search, built in the Windows system – just by pressing the “Network” icon, all the cameras of the local area network will be discovered by Windows, thanks to the UPnP function support of our cameras.

In the example below, the camera that has just been connected to the network is successfully found.

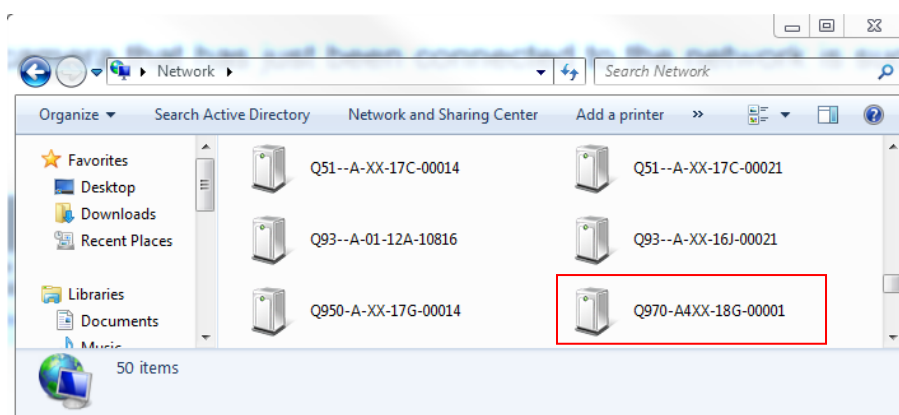

Double-click the mouse on the camera model name, the default browser of the PC is automatically launched and the IP address of the target camera is already filled in the address bar of the browser.

If you work with our cameras regularly, then **there is even a better way to discover the cameras in the network** – by using **IP Utility**. The IP Utility is a light software tool that can not only discover the cameras, but also list lots of valuable information, such as IP and MAC addresses, serial numbers, firmware versions, etc, and allows quick configuration of multiple devices at the same time.

Search and download IP Utility for free from <http://www.acti.com/DownloadCenter>.

When you launch IP Utility, the list of connected cameras in the network will be shown. See sample illustration below:

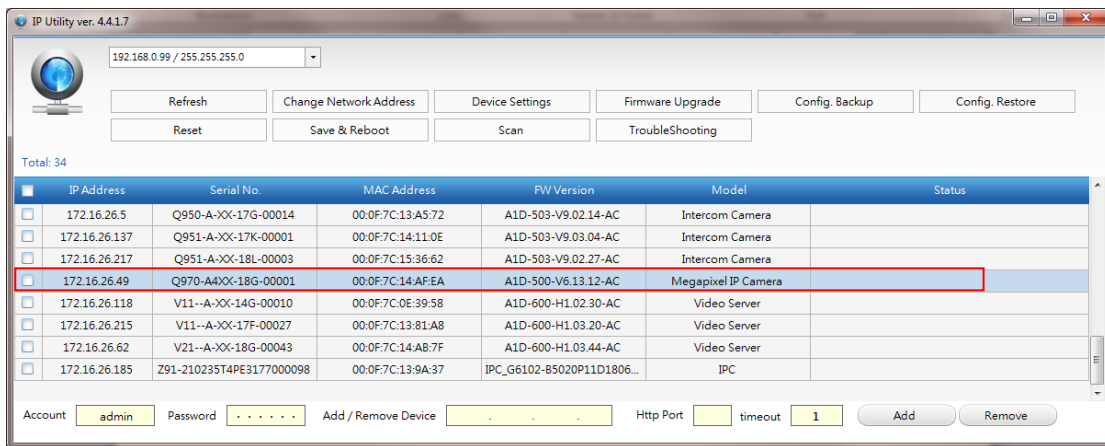

You can quickly notice the camera model in the list. Double-click on the IP address to automatically launch the default browser of the PC with the IP address of the target camera already filled in the address bar of the browser.

Use the default IP address of the camera

If there is no DHCP server in the given network, the user may have to manually assign the IP addresses to both the PC and the camera to make sure they are in the same network segment.

When the camera is plugged into the network and it does not detect any DHCP services, it will automatically assign itself a default IP:

192.168.0.100

Whereas the default port number would be **80**. In order to access that camera, the IP address of the PC has to be configured to match the network segment of the camera.

Manually adjust the IP address of the PC

In the following example, based on Windows 7, we will configure the IP address to **192.168.0.99** and set Subnet Mask to **255.255.255.0** by using the steps below:

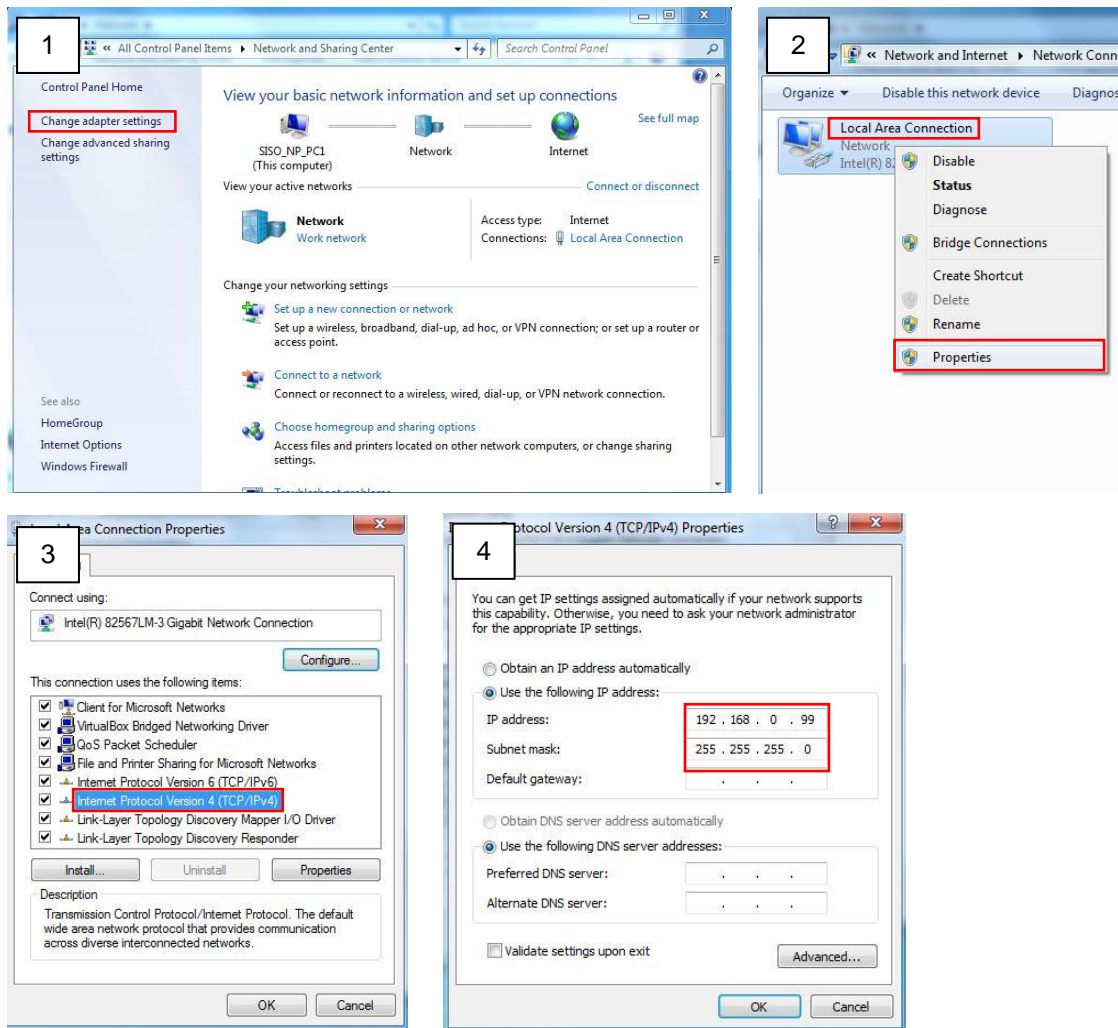

Manually adjust the IP addresses of multiple cameras

If there are more than one camera to be used in the same local area network and there is no DHCP server to assign unique IP addresses to each of them, all of the cameras would then have the initial IP address of **192.168.0.100**, which is not a proper situation for network devices – all the IP addresses have to be different from each other. The easiest way to assign cameras the IP addresses is by using **IP Utility**:

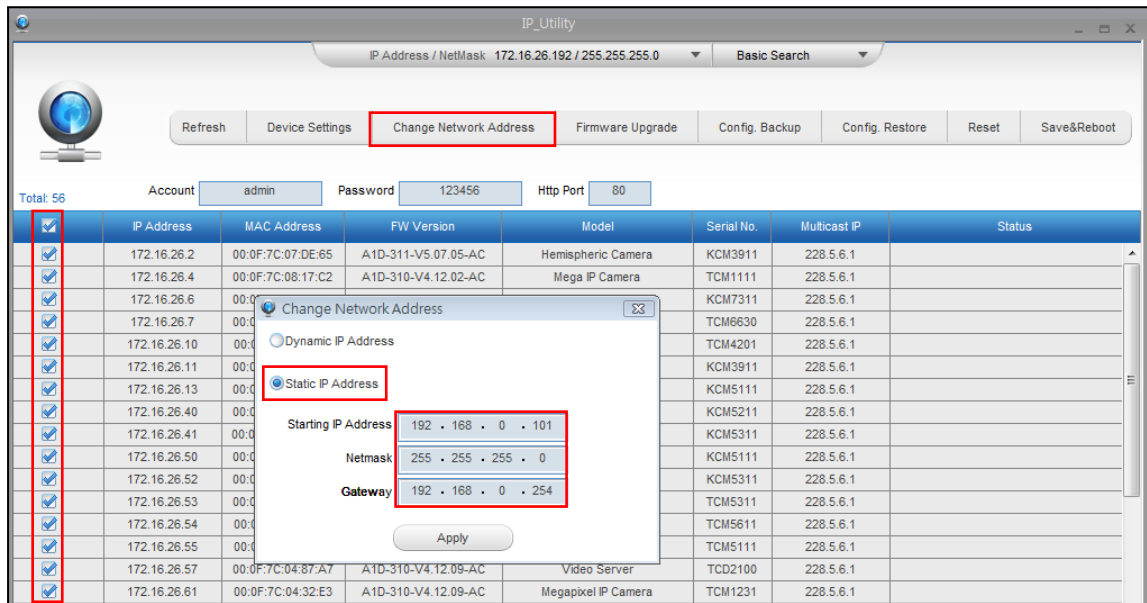

With the procedure shown above, all the cameras will have unique IP addresses, starting from 192.168.0.101. In case there are 20 cameras selected, the last one of the cameras would have the IP 192.168.0.120.

Later, by pressing the “Refresh” button of the IP Utility, you will be able to see the list of cameras with their new IP addresses.



Please note that it is also possible to change the IP addresses manually by using the Web browser. In such case, please plug in only one camera at a time, and change its IP address by using the Web browser before plugging in the next one. This way, the Web browser will not be confused about two devices having the same IP address at the same time.

Access the Camera

Now that the camera and the PC are both having their unique IP addresses and are under the same network segment, it is possible to use the Web browser of the PC to access the camera.

You can use **Microsoft Internet Explorer** to access the camera.

Functionality	Internet Explorer
Live Video	Yes
Live Video Area Resizable	Yes
PTZ Control	Yes
Capture the snapshot	Yes
Video overlay based configuration (Motion Detection regions, Privacy Mask regions)	Yes
All the other configurations	Yes

When using Internet Explorer browser, the ActiveX control for video stream management will be downloaded from the camera directly – the user just has to accept the use of such control when prompted so. No other third party utilities are required to be installed in such case.

The examples in this manual are based on Internet Explorer browser in order to cover all functions of the camera.

Assuming that the camera's IP address is **192.168.0.100**, you can access it by opening the Web browser and typing the following address into Web browser's address bar:

<http://192.168.0.100>

Upon successful connection to the camera, the user interface called **Web Configurator** would appear together with the login page. The HTTP port number was not added behind the IP address since the default HTTP port of the camera is 80, which can be omitted from the address for convenience.



Before logging in, you need to set up the root Account and Password of the camera. The password can contain upper and lower case letters and numbers.

Set Root Account Name and Password

Name	<input type="text"/>
Password	<input type="password"/>
Confirm Password	<input type="password"/>
Language	English <input type="button" value="v"/>

Then, use this newly set up **Account** and **Password** to login to the web configurator.

For further operations, please refer to the **Firmware User Manual**.



Copyright © 2022, ACTi Corporation All Rights Reserved

7F, No. 1, Alley 20, Lane 407, Sec. 2, Ti-Ding Blvd., Neihu District, Taipei, Taiwan 114, R.O.C.

TEL : +886-2-2656-2588 FAX : +886-2-2656-2599

Email: sales@acti.com