

User's Manual



8/16/24-Port Ultra PoE Managed Injector Hub

▶ UPOE-800G/UPOE-1600G/UPOE-2400G



Trademarks

Copyright © PLANET Technology Corp. 2017.

Contents are subject to revision without prior notice.

PLANET is a registered trademark of PLANET Technology Corp. All other trademarks belong to their respective owners.

Disclaimer

PLANET Technology does not warrant that the hardware will work properly in all environments and applications, and makes no warranty and representation, either implied or expressed, with respect to the quality, performance, merchantability, or fitness for a particular purpose. PLANET has made every effort to ensure that this User's Manual is accurate; PLANET disclaims liability for any inaccuracies or omissions that may have occurred.

Information in this User's Manual is subject to change without notice and does not represent a commitment on the part of PLANET. PLANET assumes no responsibility for any inaccuracies that may be contained in this User's Manual. PLANET makes no commitment to update or keep current the information in this User's Manual, and reserves the right to make improvements to this User's Manual and/or to the products described in this User's Manual, at any time without notice.

If you find information in this manual that is incorrect, misleading, or incomplete, we would appreciate your comments and suggestions.

FCC Warning

This equipment has been tested and found to comply with the limits for a Class A digital device, pursuant to Part 15 of the FCC Rules. These limits are designed to provide reasonable protection against harmful interference when the equipment is operated in a commercial environment. This equipment generates, uses, and can radiate radio frequency energy and, if not installed and used in accordance with the Instruction manual, may cause harmful interference to radio communications. Operation of this equipment in a residential area is likely to cause harmful interference in which case the user will be required to correct the interference at his own expense.

CE Mark Warning

This is a Class A product. In a domestic environment, this product may cause radio interference, in which case the user may be required to take adequate measures.

Energy Saving Note of the Device

This power required device does not support Standby mode operation. For energy saving, please remove the power cable to disconnect the device from the power circuit. In view of saving the energy and reducing the unnecessary power consumption, it is strongly suggested to remove the power connection for the device if this device is not intended to be active.

WEEE Warning



To avoid the potential effects on the environment and human health as a result of the presence of hazardous substances in electrical and electronic equipment, end users of electrical and electronic equipment should understand the meaning of the crossed-out wheeled bin symbol. Do not dispose of WEEE as unsorted municipal waste and have to collect such WEEE separately.

Revision

PLANET 8-/16-/24-Port Gigabit 60W Ultra PoE Managed Injector Hub User's Manual

FOR MODELS: UPOE-800G, UPOE-1600G, UPOE-2400G

REVISION: 1.0 (JANUARY, 2017)

Part No.: EM-UPOE-800G_1600G_2400G_v1.F

TABLE OF CONTENTS

1. INTRODUCTION	5
1.1 PACKAGE CONTENTS.....	5
1.2 PRODUCT DESCRIPTION	6
1.3 HOW TO USE THIS MANUAL.....	12
1.4 PRODUCT FEATURES	13
1.5 PRODUCT SPECIFICATIONS.....	15
2. INSTALLATION	17
2.1 HARDWARE DESCRIPTION	17
2.1.1 Injector Front Panel	17
2.1.2 LED Indicators	18
2.1.3 Injector Rear Panel.....	20
2.2 INSTALLING THE ULTRA POE MANAGED INJECTOR HUB	20
2.2.1 Desktop Installation	20
2.2.2 Rack Mounting	21
2.2.3 Network Application Installation.....	23
2.2.4 Power over Ethernet Powered Device.....	24
3 Management.....	25
3.1 OVERVIEW	25
3.2 REQUIREMENTS.....	25
3.3 MANAGEMENT METHOD	26
3.3.1 Web Management.....	26
3.3.2 PLANET Smart Discovery Utility	27
4 WEB CONFIGURATION	29
4.1 MAIN MENU.....	29
4.2 WEB PANEL	30
4.3 SYSTEM	30
4.3.1 System Information.....	31
4.3.2 IP Configuration.....	32
4.3.3 NTP Configuration	33
4.3.4 Password Setting	34
4.3.5 Firmware Upgrade.....	35

4.3.6 Configuration Setting	36
4.3.7 Factory Default	38
4.3.8 System Log	40
4.3.9 System Reboot.....	41
4.3.10 Logout	42
4.4 SNMP	44
4.4.1 SNMP Management	44
4.5 POWER OVER ETHERNET.....	46
4.5.1 PoE Configuration	47
4.5.2 PoE Schedule Profile.....	49
4.5.3 PoE Alive Check Configuration	53
4.5.4 PoE Status	54
5. Power OVER Ethernet Overview.....	55
6. The PoE Provision Process	57
6.1 LINE DETECTION.....	57
6.2 CLASSIFICATION	57
6.3 START-UP	58
6.4 OPERATION.....	58
6.5 POWER DISCONNECTION SCENARIOS	58
APPENDIX A.....	59
A.1 MDI SETTINGS.....	59
A.2 POWER DEVICE CLASSIFICATION VALUES.....	59
A.3 DATA OUT PoE INJECTOR RJ45 PORT PIN ASSIGNMENTS.....	60

1. INTRODUCTION

Thank you for purchasing PLANET 8-/16-/24-Port Gigabit 60W Ultra PoE Managed Injector Hub, UPOE-800G/UPOE-1600G/UPOE-2400G.

The description of this series is shown below:

UPOE-800G	8-Port Gigabit 60W Ultra PoE Managed Injector Hub (400 watts)
UPOE-1600G	16-Port Gigabit 60W Ultra PoE Managed Injector Hub (600 watts)
UPOE-2400G	24-Port Gigabit 60W Ultra PoE Managed Injector Hub (800 watts)

1.1 Package Contents

Open the box of the Ultra PoE Managed Injector Hub and carefully unpack it. The box should contain the following items:

- **The UPOE-800G,UPOE-1600G or UPOE-2400G x 1**
- **Quick Installation Guide x 1**
- **Power Cord x 1**
- **Rubber Feet x 4**
- **19" Rack-mounting Brackets x 2**

If any of these are missing or damaged, please contact your dealer immediately; if possible, retain the carton including the original packing material, and use them again to repack the product in case there is a need to return it to us for repair.

In the following section, the term "**Ultra PoE Managed Injector Hub**" mentioned in this user's manual refers to the UPOE-800G/UPOE-1600G/UPOE-2400G.

1.2 Product Description

PLANET Ultra PoE Managed Injector Hub series, a cost-effective and quick Ultra PoE solution, is designed to perfectly upgrade an existing network infrastructure to **Ultra Power over Ethernet** network system without replacing the existing Ethernet Switch.

Ready to Deploy Next Generation Power over Ethernet

The Ultra PoE Managed Injector Hub is a high-density, rack-mountable managed Ultra PoE Managed Injector Hub featuring PLANET **intelligent PoE** functions through **web user interface** for remote management. It provides **8/16/24 10/100/1000BASE-T** Ethernet ports featuring **Ultra PoE** injector with a total PoE budget of 400/600/800 watts. Each PoE port can deliver up to 60-watt power over Cat.5/5e/6 Ethernet UTP cables which allow data and power to transmit simultaneously to a remote 60W and 802.3at/af powered device (PD).



The Ultra PoE Managed Injector Hub enables centralization of the power supply and optimizes the installation and power management of remote network devices, and provides a quick, safe and cost-effective Power over Ethernet network solution for small businesses and enterprises.

Quick and Easy PoE Network Deployment

The Ultra PoE Managed Injector Hub is installed between a regular Ethernet Switch and the PDs. There are totally 16/32/48 RJ45 STP ports on the front panel of the Ultra PoE Managed Injector Hub, of which the 8/16/24 ports are on the lower stack functioned as "**Data input**" while the other 8/16/24 ports are on the upper stack functioned as "**PoE (Data and Power) output**". Both power and data are transferred simultaneously over the UTP cables to PDs without affecting the existing network performance and functions. With data and Power over Ethernet from one unit, the Ultra PoE Managed Injector Hub can reduce power cable deployment and eliminate the need for dedicated electrical outlets on the wall, ceiling or any unreachable place.

802.3bt Ready -- 60 Watts of Power over 4-pair UTP System

The Ultra PoE Managed Injector Hub solution adopts the IEEE 802.3at/af PoE standard. Instead of delivering power over 2-pair twisted UTP – be it end-span (Pins 1, 2, 3 and 6) or mid-span (Pins 4, 5, 7 and 8), it provides the capability to source up to 60 watts of power by using all the four pairs of standard Cat.5e/6 Ethernet cabling. In the new 4-pair system, the Ultra PoE Managed Injector Hub is able to deliver per port up to **60 watts** of power to each remote PoE compliant powered

device. It possesses double amount of power capability than the conventional 802.3at PoE and is an ideal solution to satisfying the growing demand for higher power consuming network PDs, such as:

- PoE PTZ speed dome
- Any network device that needs higher PoE power to work normally
- Thin-client
- AIO (all-in-one) touch PC, point of sale (POS) and information kiosks
- Remote digital signage display



Friendly Web Management Interface

To efficiently manage the powered devices, the Ultra PoE Managed Injector Hub provides simple **Web management interface** in which administrators can control the system and PoE functions for powered devices. It can automatically detect the power status of each port and show messages on its Web management interface. These features also provide users with a cost-effective way to manage the device via Internet whenever they are at work or at home.

PoE Configuration

Spanning Tree Admin Mode	Enable
Power Supply	53 V
Power Limit Mode	Cararption
Over Temperature Protection	Disable

PoE Temperature Limit

1	2	3	4	5	6
40°C / 104°F	50°C / 122°F	40°C / 104°F	40°C / 104°F	50°C / 122°F	60°C / 140°F

Power Allocation: 50% (800 / 1600 W)

Port	Description	PoE Function	Schedule	Power Mode	Priority	Device Class	Current Used (mA)	Powered Used (W)	Power Used (W)
1		Enable	→ Profile →	UPOE	→ High →	4	1712	55.0	0.0
2		Enable	→ Profile →	UPOE	→ High →	4	1368	61.8	0.0
3		Enable	→ Profile →	UPOE	→ High →	4	1111	28.3	0.0
4		Enable	→ Profile →	UPOE	→ High →	4	1565	61.8	0.0
5		Enable	→ Profile →	UPOE	→ High →	4	864	26.1	0.0
6		Enable	→ Profile →	UPOE	→ High →	4	404	22.0	0.0
7		Enable	→ Profile →	UPOE	→ High →	4	405	25.7	0.0
8		Enable	→ Profile →	UPOE	→ High →	4	418	22	0.0
10		Enable	→ Profile →	UPOE	→ High →	4	418	22.2	0.0
14		Enable	→ Profile →	UPOE	→ High →	4	418	20.9	0.0
17		Enable	→ Profile →	UPOE	→ High →	3	321	5.8	0.0
17		Enable	→ Profile →	UPOE	→ High →	4	422	22.4	0.0
19		Enable	→ Profile →	UPOE	→ High →	4	421	22.2	0.0
20		Enable	→ Profile →	UPOE	→ High →	4	403	22.4	0.0
21		Enable	→ Profile →	UPOE	→ High →	4	1361	61.7	0.0
22		Enable	→ Profile →	UPOE	→ High →	4	1362	62.7	0.0
23		Enable	→ Profile →	UPOE	→ High →	4	1368	62	0.0
24		Enable	→ Profile →	UPOE	→ High →	4	1354	61.2	0.0
Total							5081	608	

Buttons: [Apply] [Refresh] Auto Refresh

Built-in Unique PoE Functions for Powered Device Management

As it is the Ultra PoE Managed Injector Hub for VoIP, wireless and surveillance networks, the **Ultra PoE Managed Injector Hub** features the following special PoE management functions:

- PoE schedule
- PD alive check
- Scheduled power recycling
- UPOE, end-span or mid-span selectable in PoE power output mode
- PoE usage monitoring
- Over temperature protection

Intelligent Powered Device Alive Check

PLANET's Managed PoE products adopt not only Power over Ethernet technology, but also automated PD monitoring and real-time PoE status. The Ultra PoE Managed Injector Hub can be configured to monitor connected PD's status in real time via ping action through the uplinked Ethernet switch. Once the PD stops working and responding, the Ultra PoE Managed Injector Hub will recycle the PoE port power and bring the PD back to work. It also will greatly enhance the network reliability in that the PoE port will reset the PD power, thus reducing administrator's management burden.



PoE Schedule for Energy Saving

Under the trend of energy saving worldwide and contributing to environmental protection on the Earth, the Ultra PoE Managed Injector Hub can effectively control the power supply besides its capability of giving high watts power. The built-in “PoE schedule” function helps you to enable or disable PoE power feeding for each PoE port during specified time intervals and it is a powerful function to help SMBs or enterprises save power and money. It also increases security by powering off PDs that should not be in use during non-business hours.

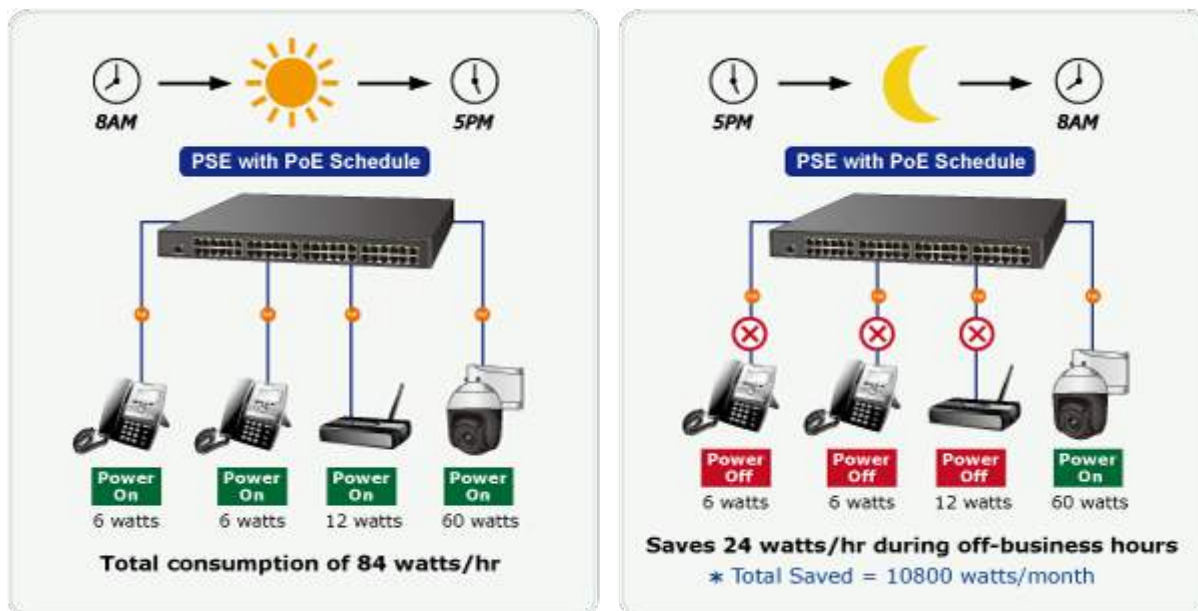

Advanced PoE Power Output Mode Management

To fulfill the demand of various powered devices consuming stable PoE power, the Ultra PoE Managed Injector Hub provides three different PoE power output modes for selection.

- **60W UPOE PoE Power Output Mode** (Pins 1, 2, 3, 6 + Pins 4, 5, 7, 8)
- **30W End-span PoE Power Output Mode** (Pins 1, 2, 3, 6)
- **30W Mid-span PoE Power Output Mode** (Pins 4, 5, 7, 8)

Selectable End-span/Mid-span/UPOE Power Inline Mode

Port	PoE Mode	Schedule	Power Inline Mode	Priority	PD Class	Current Used [mA]	Power Used [W]	Power Allocation [W]
1	Enable ▼	Profile 1 ▼	UPoE ▼	Critical ▼	--	0	0	60
2	Enable ▼	Profile 1 ▼	End-span ▼	Critical ▼	--	0	0	30
3	Enable ▼	Profile 1 ▼	UPoE End-span Mid-span	Critical ▼	--	0	0	60

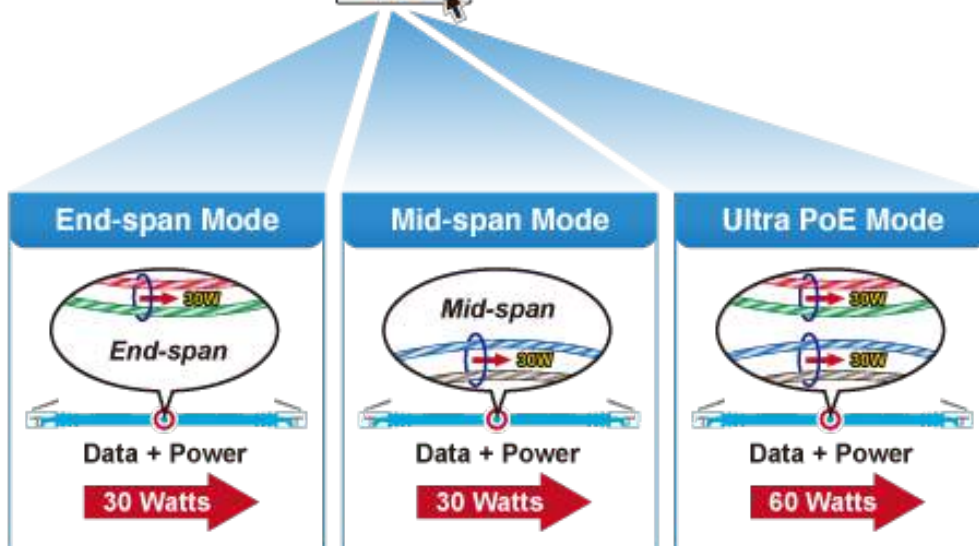

Advanced Power Management

To facilitate power management, the Ultra PoE Managed Injector Hub comes with powerful PoE management features such as **over temperature protection**, **usage threshold alert** and **auto power allocation** to prevent power budget overloading. The PoE power budget can be allocated by priorities or classification and sent alert event logs when power usage reaches the defined threshold.

Intelligent LED Indicator for Real-time PoE Usage

The Ultra PoE Managed Injector Hub helps users to monitor the current status of PoE power usage easily and efficiently by its advanced LED indication. The front panel of the UPOE-800G has four green LEDs indicating **100W**, **200W**, **300W** and **400W** of PoE power usage.



The front panel of the UPOE-1600G also has four green LEDs indicating **150W**, **300W**, **450W** and **600W** of PoE power usage.



PoE Usage Monitoring

Via the power usage chart in the web management interface, the Ultra PoE Managed Injector Hub enables the administrator to monitor the status of the power usage of the connected PDs in real time.

High Power Budget for 802.3af PoE Extension

With IEEE 802.3af/802.3at PoE output capability, the Ultra PoE Managed Injector Hub can extend much longer distance by using PLANET PoE Extender for powering up the PoE PD which can be installed over more than 100 meters away. By daisy-chaining multiple PLANET PoE Extenders, it offers the great flexibility of doubling, tripling or quadrupling the distance of PoE network.

Smart Fan Design for Silent Operation

The Ultra PoE Managed Injector Hub features a low noise design and an effective ventilation system. It supports the smart fan technology that automatically controls the speed of the built-in fan to reduce noise and maintain the temperature of the Ultra PoE Managed Injector Hub for optimal power output capability. The Ultra PoE Managed Injector Hub is able to operate reliably, stably and quietly in any environment without affecting its performance.

1.3 How to Use This Manual

This User Manual is structured as follows:

- **Section 2, Installation**

It explains the functions of Ultra PoE Managed Injector Hub and how to physically install the Ultra PoE Managed Injector Hub.

- **Section 3, Management**

It contains information about the software function of the Ultra PoE Managed Injector Hub.

- **Section 4, Web Configuration**

The section explains how to manage the Ultra PoE Managed Injector Hub through Web interface.

- **Section 5, Power over Ethernet overview**

The section explains the Power over Ethernet theories.

- **Section 6, PoE Power Provision Process**

The section explains the PoE power provision process.

- **Appendix A**

It contains cable information of Ultra PoE Managed Injector Hub.

1.4 Product Features

➤ **Interface**

UPOE-800G

- Complies with the IEEE 802.3, IEEE 802.3u and IEEE 802.3ab Ethernet standards
- **16-port RJ45**
 - 8-port 10/100/1000Mbps “**Data input**”
 - 8-port 10/100/1000Mbps “**Data + Power output**”
- One 10/100/1000BASE-T management port

UPOE-1600G

- Complies with the IEEE 802.3, IEEE 802.3u and IEEE 802.3ab Ethernet standards
- **32-port RJ45**
 - 16-port 10/100/1000Mbps “**Data input**”
 - 16-port 10/100/1000Mbps “**Data + Power output**”
- One 10/100/1000BASE-T management port

UPOE-2400G

- Complies with the IEEE 802.3, IEEE 802.3u and IEEE 802.3ab Ethernet standards
- **48-port RJ45**
 - 24-port 10/100/1000Mbps “**Data input**”
 - 24-port 10/100/1000Mbps “**Data + Power output**”
- One 10/100/1000BASE-T management port

➤ **Power over Ethernet**

- Ultra Power over Ethernet end-span/mid-span PSE
- Up to 60 watts of power on 4-pair UTP
- Backward compatible with IEEE 802.3at/af PD device
- 54V DC, 60-watt PoE power output at maximum on each port, 400-watt PoE budget (UPOE-800G)
- 52V DC, 60-watt PoE power output at maximum on each port, 600-watt PoE budget (UPOE-1600G)
- 54V DC, 60-watt PoE power output at maximum on each port, 800-watt PoE budget (UPOE-2400G)
- Auto-detection of IEEE 802.3at/af PoE equipment and device to avoid possible damage by incorrect installation
- Circuit protection prevents power interference between ports
- Remote power feeding up to 100m

➤ **PoE Management**

- Per port PoE power schedule
- PoE function enable/disable
- Per port PoE function enable/disable
- PoE port power feeding priority

- PD classification detection
- Over temperature protection
- PD alive check
- PoE schedule

➤ **Management**

- Web interface for remote management
- Supports Network Time Protocol (NTP)
- Firmware upgrade through Web interface
- PLANET Smart Discovery utility automatically finds PLANET devices on the network
- SNMP trap for alarm notification of events
- System log/remote syslog

➤ **Hardware**

- 19-inch rack mountable; 1U height
- Reset button for resetting to default setting and system reboot
- LED indicators for PoE ready and PoE activity
- LED indicators for power alert and fan alert
- LED indicators for PoE power usage status (watts), UPOE-800G/UPOE-1600G only
- FCC Part 15 Class A, CE

1.5 Product Specifications

Product	UPOE-800G	UPOE-1600G	UPOE-2400G	
Hardware				
Interface	“Data” Input Ports	8 x RJ45	16 x RJ45	24 x RJ45
	“Data + Power” Output Ports	8 x RJ45	16 x RJ45	24 x RJ45
	Management Port	1 x RJ45; 10/100/1000BASE-T, auto-negotiation, auto-MDI/MDIX		
Data Rate	10/100/1000Mbps			
LED	System: SYS PWR x 1 (green) PoE Failure x 1 (red) Fan Failure x 2 (red) Management port x 2: 1000 (green), 10/100(orange) Per PoE Port: Ultra 60W PoE-in-use x 1 (green) 802.3at/af PoE-in-use x1 (orange) PoE Power Usage LED x4 (green), UPOE-800G/UPOE-1600G only			
Power Requirements	100-240V AC, 50/60 Hz, 6.5A	100-240V AC, 50/60 Hz, 8A	100-240V AC, 50/60 Hz, 15A	
Power Consumption	520 watts (max.) / 1774BTU	800 watts (max) / 2729BTU	1000 watts (max.) / 3412BTU	
Ventilation	Fan x 3	Fan x 3	Fan x 3	
Dimensions (W x D x H)	440 x 300 x 44.5 mm, 1U height	440 x 300 x 44.5 mm, 1U height	440 x 300 x 44.5 mm, 1U height	
Enclosure	Metal	Metal	Metal	
Weight	4.2kg	4.8kg	5.5kg	
Power over Ethernet				
PoE Standard	IEEE 802.3bt IEEE 802.3at Power over Ethernet Plus 4-pair Ultra PoE			
PoE Power Supply Type	End-span/Mid-span/UPoE(Ultra PoE)			
Power Pin Assignment	Pair 1 end-span: 1/2(-), 3/6(+) Pair 2 mid-span: 4/5(+), 7/8(-) UPoE: 1/2(-), 3/6(+), 4/5(+), 7/8(-)			
PoE Power Output	DC 54V/60-watt PoE via 4-pair DC 54V/30-watt PoE via 2-pair	DC 52V/60-watt PoE via 4-pair DC 52V/30-watt PoE via 2-pair	DC 54V/60-watt PoE via 4-pair DC 54V/30-watt PoE via 2-pair	
PoE Power Budget	400 watts/1364BTU	600 watts/2047BTU	800 watts/2729BTU	
Number of 60W PDs can be powered	6	10	13	
Number of 802.3af PDs (Class 0, 1, 2, 3) can be powered	8	16	24	
Number of 802.3at PDs (Class 1, 2, 3) can be powered	8	16	24	
Number of 802.3at PDs (Class 0, 4) can be powered	8	16	24	

Management	
Management Interface	Web, PLANET Smart Discovery Lite
PoE Management	Power limit by consumption and allocation PoE admin mode Per port power schedule Per port power enable/disable Power feeding priority Over temperature protection Current per port usage and status Total power consumption PD alive check Scheduled power recycling
Management Feature	Setup of system/management functions Web firmware upgrade SNMP trap for alarm notification of events
Standards Conformance	
Regulatory Compliance	FCC Part 15 Class A, CE
Standards Compliance	IEEE 802.3 10BASE-T Ethernet IEEE 802.3u 100BASE-TX Fast Ethernet IEEE 802.3ab 1000BASE-T Gigabit Ethernet IEEE 802.3at Power over Ethernet Plus IEEE 802.3af Power over Ethernet RFC 768: UDP RFC 791: IP RFC 2068 HTTP RFC 1157: SNMP v1 RFC 1902: SNMP v2c RFC 5424: Syslog
Network Cable	10BASE-T: 4-pair UTP Cat5 up to 100m (328ft) 100BASE-TX: 4-pair UTP Cat5 up to 100m (328ft) 1000BASE-T: 4-pair UTP Cat5e/6 up to 100m (328ft) EIA/TIA- 568 100-ohm STP (100m)
Environments	
Operating	Temperature: 0 ~ 50 degrees C Relative Humidity: 5 ~ 90% (non-condensing)
Storage	Temperature: -10 ~ 70 degrees C Relative Humidity: 5 ~ 90% (non-condensing)

2. INSTALLATION

This section describes the hardware features and installation of Ultra PoE Managed Injector Hub on the desktop or rack mount. For easier management and control of the Ultra PoE Managed Injector Hub, familiarize yourself with its display indicators, and ports. Front panel illustrations in this chapter display the unit LED indicators. Before deploying the Ultra PoE Managed Injector Hub, please read this chapter completely.

2.1 Hardware Description

The section describes the hardware of the Ultra PoE Managed Injector Hub and gives a physical and functional overview.

2.1.1 Injector Front Panel

The unit front panel provides a simple interface monitoring the Ultra PoE Managed Injector Hub. [Figures 2-1-1, 2-1-2 and 2-1-3](#) show the front panels of the Ultra PoE Managed Injector Hubs.

■ Front Panel of UPOE-800G



Figure 2-1-1: UPOE-800G Front Panel

■ Front Panel of UPOE-1600G



Figure 2-1-2: UPOE-1600G Front Panel

■ Front Panel of UPOE-2400G



Figure 2-1-3: UPOE-2400G Front Panel

■ Reset button

At the left of the front panel, the reset button is designed for rebooting the Ultra PoE Managed Injector Hub without turning off and on the power.



Figure 2-1-4: Reset Button of Ultra PoE Managed Injector Hub

The following is the summary table of reset button functions:

Reset Button Pressed and Released	Function
About 5 second	Reboot the Ultra PoE Managed Injector Hub.
About 10 seconds	Reset the Ultra PoE Managed Injector Hub to Factory Default configuration. The Ultra PoE Managed Injector Hub will reboot and load the default IP settings.



Be sure that you back up the current configuration of Ultra PoE Managed Injector Hub before resetting Ultra PoE Managed Injector Hub or else the entire configuration will be erased when pressing the **"RESET"** button.

2.1.2 LED Indicators

The front panel LEDs indicates instant status of system power, PoE and fan failure, management port speed and Link/Active, PoE power usage status and per PoE port links status, thus helping administrator to monitor and troubleshoot when needed.

UPOE-800G

System

LED	Color	Function
SYS Power	Green	Lights to indicate power on.
PoE Fail	Red	Lights to indicate PoE module failure.
FAN1 Fail	Red	Lights to indicate FAN1 stops.
FAN2 Fail	Red	Lights to indicate FAN2 stops.
1000	Green	Lights to indicate management port is working on 1000Mbps Ethernet speed.
10/100	Orange	Lights to indicate management port is working on 10/100Mbps Ethernet speed.

PoE Power Usage (W)

LED	Color	Function
100W	Green	Lights to indicate the PoE power consumption has 100W or over.
200W	Green	Lights to indicate the PoE power consumption has 200W or over.
300W	Green	Lights to indicate the PoE power consumption has 300W or over.
400W	Green	Lights to indicate the PoE power consumption has 400W.

Per PoE Port:

LED	Color	Function
Ultra 60W PoE-in-Use	Green	Lights to indicate that the port is in use and supplying 54V DC power.
802.3at/af PoE-in-Use	Orange	Lights to indicate that the port is in use and supplying 54V DC power.

UPOE-1600G

■ **System**

LED	Color	Function
SYS Power	Green	Lights to indicate power on.
PoE Fail	Red	Lights to indicate PoE module failure.
FAN1 Fail	Red	Lights to indicate FAN1 stops.
FAN2 Fail	Red	Lights to indicate FAN2 stops.
1000	Green	Lights to indicate management port is working on 1000Mbps Ethernet speed.
10/100	Orange	Lights to indicate management port is working on 10/100Mbps Ethernet speed.

■ **PoE Power Usage (W)**

LED	Color	Function
150W	Green	Lights to indicate the PoE power consumption has 150W or over.
300W	Green	Lights to indicate the PoE power consumption has 300W or over.
450W	Green	Lights to indicate the PoE power consumption has 450W or over.
600W	Green	Lights to indicate the PoE power consumption has 600W.

■ **Per PoE Port:**

LED	Color	Function
Ultra 60W PoE-in-Use	Green	Lights to indicate that the port is in use and supplying 52V DC power.
802.3at/af PoE-in-Use	Orange	Lights to indicate that the port is in use and supplying 52V DC power.

UPOE-2400G

■ **System**

LED	Color	Function
SYS Power	Green	Lights to indicate power on.
PoE Fail	Red	Lights to indicate PoE module failure.
FAN1 Fail	Red	Lights to indicate FAN1 stops.
FAN2 Fail	Red	Lights to indicate FAN2 stops.
1000	Green	Lights to indicate management port is working on 1000Mbps Ethernet speed.
10/100	Orange	Lights to indicate management port is working on 10/100Mbps Ethernet speed.

■ **Per PoE Port:**

LED	Color	Function
Ultra 60W PoE-in-Use	Green	Lights to indicate that the port is in use and supplying 54V DC power.
802.3at/af PoE-in-Use	Orange	Lights to indicate that the port is in use and supplying 54V DC power.

2.1.3 Injector Rear Panel

The rear panel of the Ultra PoE Managed Injector Hub indicates an AC inlet power socket, which accepts input power from 100 to 240V AC, 50/60Hz. [Figures 2-1-5 & 2-1-6](#) shows the rear panel of the Ultra PoE Managed Injector Hub.



Figure 2-1-5: UPOE-800G/UPOE-1600G Rear Panel



Figure 2-1-6: UPOE-2400G Rear Panel



The Ultra PoE Managed Injector Hub is a power-required device, meaning Ultra PoE Managed Injector Hub will not work till it is powered. If your networks should be active all the time, please consider using UPS (Uninterrupted Power Supply) for your device. It will prevent you from network data loss or network downtime.



In some areas, installing a surge suppression device may also help to protect your device from being damaged by unregulated surge or current to the Ultra PoE Managed Injector Hub or the power adapter.

2.2 Installing the Ultra PoE Managed Injector Hub

This section describes how to install your Ultra PoE Managed Injector Hub and make connections to the Ultra PoE Managed Injector Hub. Please read the following topics and perform the procedures in the order being presented. PLANET Ultra PoE Managed Injector Hub does not need software configuration.

2.2.1 Desktop Installation

To install an Ultra PoE Managed Injector Hub on a desktop or shelf, simply complete the following steps:

Step 1: Attach the rubber feet to the recessed areas on the bottom of the Ultra PoE Managed Injector Hub.

Step 2: Place the Ultra PoE Managed Injector Hub on a desktop or shelf near an AC power source.

Step 3: Keep enough ventilation space between the Ultra PoE Managed Injector Hub and the surrounding objects.



Figure 2-2-1: Desktop Installation of the Ultra PoE Managed Injector Hub



When choosing a location, please keep in mind the environmental restrictions discussed in Chapter 1, Section 5, under Specifications.

Step 4: Connect your Ultra PoE Managed Injector Hub to network 60W/802.3at/802.3af powered devices (PD) and Switch.

- A. Connect one end of a standard network cable to the upper stack 10/100/1000 RJ45 ports on the front of the Ultra PoE Managed Injector Hub.
- B. Connect the other end of the cable to the 60W/802.3at/802.3af powered devices (PD) such as IP phone, wireless access point, IP camera, splitter, or switch etc.
- C. Connect one end of a standard network cable to the relative lower stack 10/100/1000 RJ45 port on the front of the Ultra PoE Managed Injector Hub.
- D. Connect the other end of the cable to the port of Switch.



Connecting to the Ultra PoE Managed Injector Hub requires UTP Category 5e / 6 network cabling with RJ45 tips. For more information, please see the Cabling Specification in Appendix A.

Step 5: Supplying Power to the Ultra PoE Managed Injector Hub.

- A. Connect one end of the power cable to the Ultra PoE Managed Injector Hub.
- B. Connect the power plug of the power cable to a standard wall outlet.

When the Ultra PoE Managed Injector Hub receives power, the Power LED should remain solid Green.

2.2.2 Rack Mounting

To install the Ultra PoE Managed Injector Hub in a 19-inch standard rack, follow the instructions described below.

Step 1: Place your Ultra PoE Managed Injector Hub on a hard flat surface, with the front panel positioned towards your front side.

Step 2: Attach a rack-mount bracket to each side of the Ultra PoE Managed Injector Hub with supplied screws attached to the package. [Figure 2-2-2](#) shows how to attach brackets to one side of the Ultra PoE Managed Injector Hub.



Figure 2-2-2: Brackets attaching to the Ultra PoE Managed Injector Hub



You must use the screws supplied with the mounting brackets. Damage caused to the parts by using incorrect screws would invalidate the warranty.

Step 3: Secure the brackets tightly.

Step 4: Follow the same steps to attach the second bracket to the opposite side.

Step 5: After the brackets are attached to the Injector, use suitable screws to securely attach the brackets to the rack, as shown in [Figure 2-2-3](#).

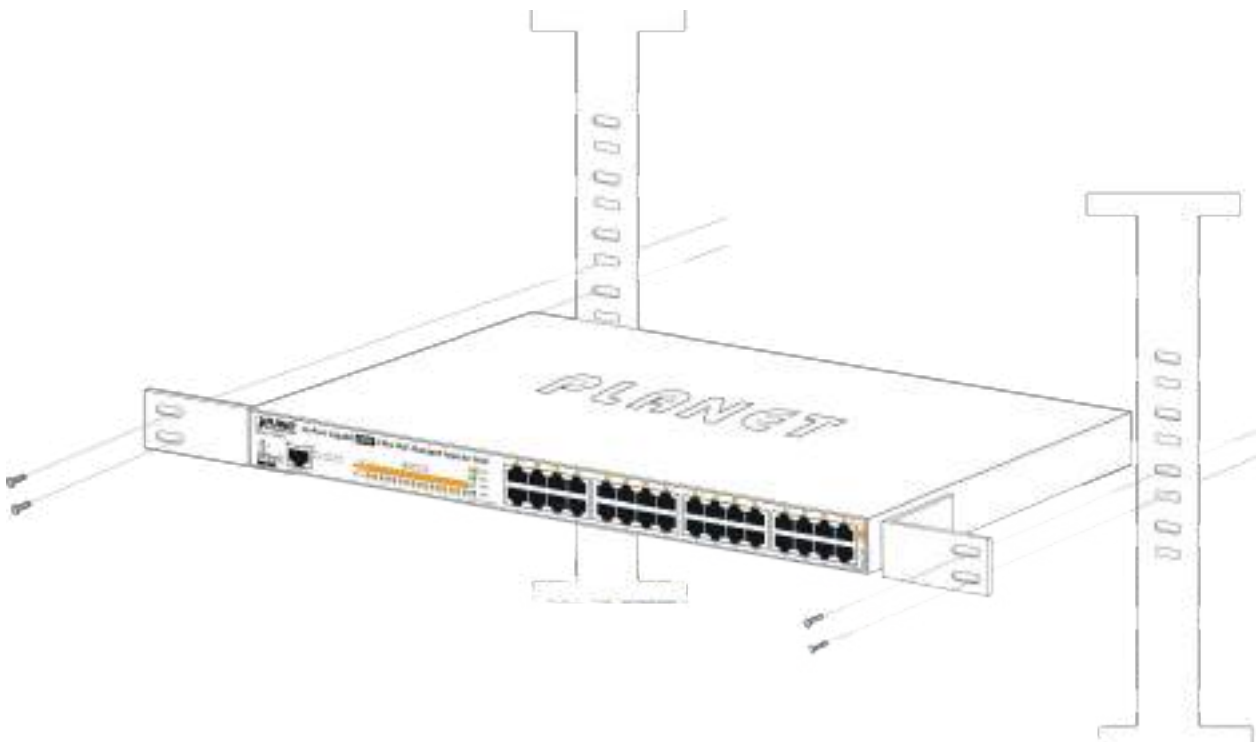

Figure 2-2-3: Mounting the Ultra PoE Managed Injector Hub in a Rack

Step 6: Proceed with steps 4 and 5 of session **2.2.1 Desktop Installation** to connect the network cabling and supply power to your Ultra PoE Managed Injector Hub.

2.2.3 Network Application Installation

The Ultra PoE Managed Injector Hub is not an equipment with data switching function between data ports. To inject PoE power and transmit data packets to PDs, the Ultra PoE Managed Injector Hub is usually linked to an Ethernet switch. Typically, the Ultra PoE Injector is installed between regular Ethernet switch and PDs, and mostly it is located close to the Ethernet switch side.

To install an Ultra PoE Managed Injector Hub on a network environment, simply complete the following steps:

Step 1: Power on the Ultra PoE Managed Injector Hub and connect the RJ45 cable from the “Data” port to the Ethernet switch port.

Step 2: Connect the RJ45 cable from the “Data + Power” ports to the PDs, such as VoIP phone and IP camera.

Step 3: Check the link status on both PD and Ethernet switch. Once the Injector starts to deliver 52V/54V power over RJ45 cables to PDs, the PoE-in-Use LED of the Ultra PoE Managed Injector Hub will light up.

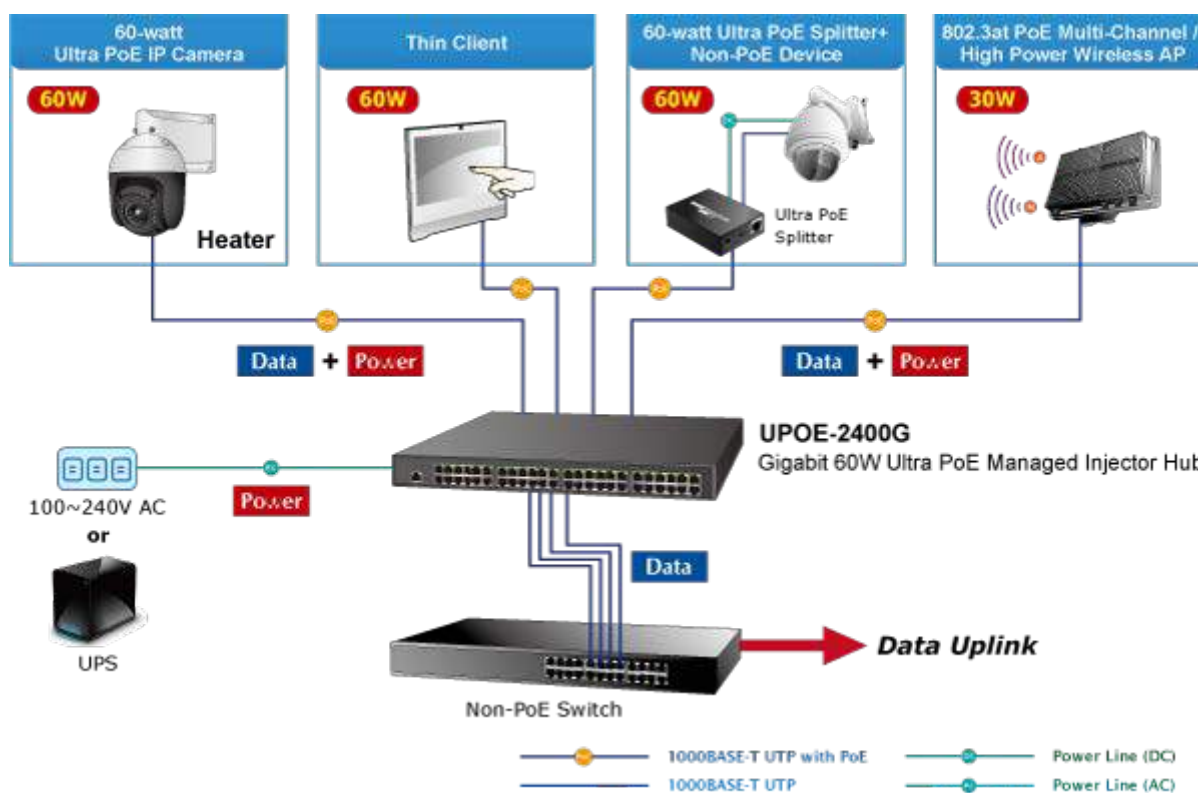







Figure 2-2-4: Network application installation

The Ultra PoE Managed Injector Hub supports data passive mode, that is, even the Ultra PoE Managed Injector Hub is manually powered off. The data between “DATA” port and “DATA & PWR” port can still be transmitted without data loss.

2.2.4 Power over Ethernet Powered Device

 <p>3~5 watts</p>	<p>Voice over IP phones</p> <p>Enterprise can install PoE VoIP Phone, ATA and other Ethernet/non-Ethernet end-devices in the central area where UPS is installed for un-interruptible power system and power control system.</p>
 <p>6~12 watts</p>	<p>Wireless LAN Access Points</p> <p>Museums, sightseeing spots, airports, hotels, campuses, factories, and warehouses can install the Access Point anywhere.</p>
 <p>10~12 watts</p>	<p>IP Surveillance</p> <p>Enterprises, museums, campuses, hospitals and banks can install IP camera without the limit of the installation location. Electrician is not needed to install AC sockets.</p>
 <p>3~60 watts</p>	<p>PoE Splitter</p> <p>PoE Splitter splits the PoE DC over the Ethernet cable into 5/12/19/24V DC power output. It frees the device deployment from restrictions due to power outlet locations, which eliminate the costs for additional AC wiring and reduces the installation time.</p>
 <p>30~60 watts</p>	<p>High Power Speed Dome</p> <p>This state-of-the-art design is considerable to fit in various network environments like traffic centers, shopping malls, railway stations, warehouses, airports, and production facilities for the most demanding outdoor surveillance applications. Electrician is not needed to install AC sockets.</p>



Since the Ultra PoE Managed Injector Hub per PoE port supports **52V (UPOE-1600G)** or **54V DC (UPOE-800G/UPOE-2400G)** PoE power output, please check and assure the Powered Device's (PD) acceptable DC power is **52V (UPOE-1600G)** and **54V DC (UPOE-800G/UPOE-2400G)**; otherwise, it will damage the Powered Device (PD).

3 MANAGEMENT

This chapter describes how to manage the Ultra PoE Managed Injector Hub with the following topics included:

- **Overview**
- **Management Method**
- **Logging on to the Ultra PoE Managed Injector Hub**

3.1 Overview

The Ultra PoE Managed Injector Hub provides a user-friendly, Web interface where you can perform various device configuration and management activities, including:

- **System**
- **SNMP**
- **Power over Ethernet**

3.2 Requirements

- **Network cables**
Use standard network (UTP) cables with RJ45 connectors.
- **Workstations running Windows XP/2003/Vista/7/8/2008/10, MAC OS X or later, Linux, UNIX, or other platforms are compatible with TCP/IP protocols.**
- **Workstations are installed with Ethernet NIC (Network Interface Card)**

Ethernet Port Connection

- **Network cables -- Use standard network (UTP) cables with RJ45 connectors.**
- **The above PC is installed with Web browser and JAVA runtime environment plug-in.**



It is recommended to use **Internet Explorer 11** or above to access the Ultra PoE Managed Injector Hub. If the Web interface of the Ultra PoE Managed Injector Hub is not accessible, please turn off the anti-virus software or firewall and then try it again.

3.3 Management Method

User can manage the Ultra PoE Managed Injector Hub by Web Management via a network connection.

3.3.1 Web Management

The Ultra PoE Managed Injector Hub can be configured through an Ethernet connection. The factory default IP address is **192.168.0.100** with subnet mask **255.255.255.0**, so please make sure the manager PC must be set to the same **IP subnet address**. For example, if Ultra PoE Managed Injector Hub IP address is set to factory default, then your manager PC should be set to **192.168.0.x** (where x is a number between 1 and 254, except 100) with a subnet mask of **255.255.255.0**.

1. Use Internet Explorer 8.0 or above Web browser. Enter IP address **http://192.168.0.100** to access the Web interface.

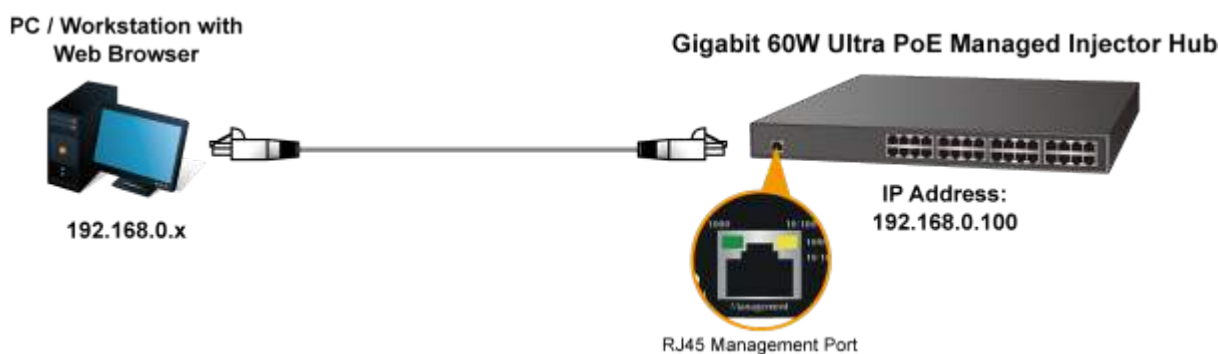

Figure 3-1-1: IP Management Diagram

2. When the following login screen appears, please enter the default username "**admin**" and password "**admin**" to login the main screen of Ultra PoE Managed Injector Hub. The login screen in [Figure 3-1-2](#) appears.

Default IP Address: **192.168.0.100**

Default Account: **admin**

Default Password: **admin**



Figure 3-1-2: Ultra PoE Managed Injector Hub Web Login Screen



1. For security reason, please change and memorize the new password after this first setup.
2. Only accept command in lowercase letter under Web interface.

3.3.2 PLANET Smart Discovery Utility

For easily listing the Ultra PoE Managed Injector Hub in your Ethernet environment, Planet Smart Discovery Utility from user's manual CD-ROM is an ideal solution.

The following installation instructions guide you to running Planet Smart Discovery Utility.

Deposit Planet Smart Discovery Utility in administrator PC.

Run this utility and the following screen appears.



Figure 3-1-3: Planet Smart Discovery Utility Screen



If there are two LAN cards or above in the same administrator PC, choose a different LAN card by using the “**Select Adapter**” tool.

1. Press the “**Refresh**” button for the currently-connected devices in the discovery list and the screen is shown as follows:



Figure 3-1-4: Planet Smart Discovery Utility Screen

This utility shows all necessary information from the devices, such as MAC address, device name, firmware version and device IP subnet address. It can also assign new password, IP subnet address and description of the devices.

After setup is completed, press the “**Update Device**”, “**Update Multi**” or “**Update All**” button to take effect. The definitions of the 3 buttons above are shown below:

Update Device: Use current setting on one single device.

Update Multi: Use current setting on multi-devices.

Update All: Use current setting on whole devices in the list.

The same functions mentioned above also can be found in “**Option**” tools bar.

By clicking the “**Control Packet Force Broadcast**” function, it allows you to assign new setting value to the Ultra PoE Managed Injector Hub under a different IP subnet address.

Press the “**Connect to Device**” button and then the Web login screen appears in [Figure 3-1-2](#).

Press the “**Exit**” button to shut down Planet Smart Discovery Utility.

4 WEB CONFIGURATION

The Ultra PoE Managed Injector Hub provides Web interface for PoE smart function configuration and makes the Ultra PoE Managed Injector Hub operate more effectively. They can be configured through the Web browser. A network administrator can manage and monitor the Ultra PoE Managed Injector Hub from the local LAN. This section indicates how to configure the Ultra PoE Managed Injector Hub to enable its smart function.



The following web screen is based on the UPOE-2400G. The display of the UPOE-800G and UPOE-1600G is the same as that of the UPOE-2400G.

4.1 Main Menu

After a successful login, the main screen appears. The main screen, as shown in [Figure 4-1-1](#), displays the product name, the function menu, and the main information in the center.



Figure 4-1-1: Web Main Menu screen

The descriptions of the four items are as follows:

Object	Description
■ System	Provides System information of Ultra PoE Managed Injector Hub. Explained in section 4.3.
■ SNMP	Provides SNMP Trap information and system information. Explained in section 4.4.
■ Power over Ethernet	Provides PoE Management configuration of Ultra PoE Managed Injector Hub. Explained in section 4.5.

4.2 Web Panel

At the top of the Web management page, the active panel displays the link status of management port and PoE ports.



Figure 4-2-1: Web Panel Screen

- **Green** light indicates network data is sending or receiving.
- **Orange** light indicates the PoE is in use.

4.3 System

The System function provides system information which also allows user to manage the Ultra PoE Managed Injector Hub system as [Figure 4-2-2](#) is shown below:

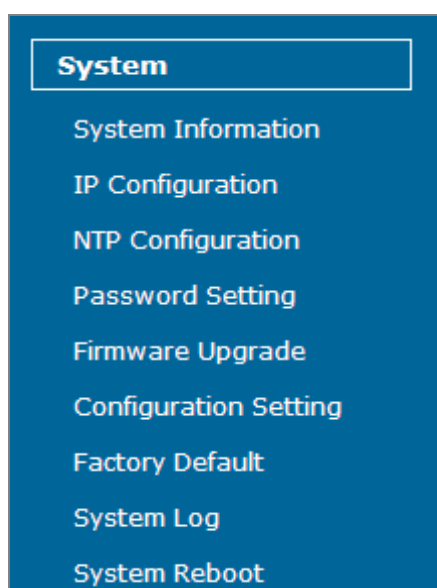

Figure 4-2-2: System Function Menu

The page includes the following information:

Object	Description
<ul style="list-style-type: none"> • System Information 	Display the MAC address, Software Version, Hardware Version, IP Address, Subnet Mask, Gateway and Description. Explained in section 4.3.1.
<ul style="list-style-type: none"> • IP Configuration 	Allow to change the IP subnet address of Ultra PoE Managed Injector Hub. Explained in section 4.3.2.
<ul style="list-style-type: none"> • NTP Configuration 	Allow to set system time by manual or synchronize system time from Internet NTP server. Explained in section 4.3.3.
<ul style="list-style-type: none"> • Password Setting 	Allow to change the username and password of Ultra PoE Managed Injector Hub. Explained in section 4.3.4.

• Firmware Upgrade	Allow to upgrade the latest firmware in the future. Explained in section 4.3.5.
• Configuration Setting	Allow to back up or restore system configuration. Explained in section 4.3.6.
• Factory Default	Allow to reset system to factory default setting. Explained in section 4.3.7.
• System Log	Allow to enable system log and to record system log. Explained in section 4.3.8.
• System Reboot	Allow to reboot system. Explained in section 4.3.9.

4.3.1 System Information

This section displays system information of Ultra PoE Managed Injector Hub as the screen in [Figure 4-3-1](#) appears. [Table 4-3-1](#) describes the system information of the Ultra PoE Managed Injector Hub.

System Information

System Information	
System Name	UPOE-2400G
MAC Address	00:30:4f:11:22:33
Software Version	v1.253b161129
Build Time	Tue Nov 29 10:55:17 CST 2016
Hardware Version	V 1.0
Attain IP Protocol	Fixed IP
IP Address	192.168.0.100
Subnet Mask	255.255.255.0
Gateway	192.168.0.254
Time	
System Date	2016/11/29 11:17
System Uptime	0day:0h:10m:24s

Figure 4-3-1: System Information Web Page Screen

Object	Description
• System Name	Displays the Ultra PoE Managed Injector Hub model name.
• MAC Address	Displays the MAC address of Ultra PoE Managed Injector Hub.
• Software Version	Displays the current firmware version of Ultra PoE Managed Injector Hub.
• Build Time	Displays the firmware build time.
• Hardware Version	Displays the hardware version of Ultra PoE Managed Injector Hub.
• Attain IP Protocol	Displays the currently attained IP protocol of Ultra PoE Managed Injector Hub.
• IP Address	Displays the current IP address of Ultra PoE Managed Injector Hub.
• Subnet Mask	Displays the current subnet mask address of Ultra PoE Managed Injector Hub.
• Gateway	Displays the current gateway address of Ultra PoE Managed Injector Hub.
• System Date	Displays the current system date of Ultra PoE Managed Injector Hub. The system date will be correct if NTP function is enabled and the Hub is connected to Internet.
• System UpTime	Displays when the system will start up.

Table 4-3-1: Descriptions of the System Information Objects Screen

4.3.2 IP Configuration

This section provides the IP Configuration of Ultra PoE Managed Injector Hub as the screen in [Figure 4-3-2](#) appears. [Table 4-3-2](#) describes the IP Configuration object of Ultra PoE Managed Injector Hub.

IP Configuration

DHCP Client	Disable ▼
IP Address	192.168.0.100
Subnet Mask	255.255.255.0
Default Gateway	192.168.0.254

Figure 4-3-2: IP Configuration Web Page Screen

Object	Description
• DHCP Client	Allows to disable or enable the DHCP Client function of Ultra PoE Managed Injector Hub.
• IP Address	Allows to input new IP Address of Ultra PoE Managed Injector Hub.
• Subnet Mask	Allows to input new Subnet Mask Address of Ultra PoE Managed Injector Hub.
• Default Gateway	Allows to input new Default Gateway Address of Ultra PoE Managed Injector Hub.
• Apply	Press this button to take effect.
• Reset	Press this button to reset IP Configuration to default mode.

Table 4-3-2: Descriptions of the IP Configuration Objects Screen



If Ultra PoE Managed Injector Hub has not received IP address from DHCP server, then user still can connect to the IP address before changing to DHCP client mode, or user can use Smart Discovery Utility to find out what IP address set in the Ultra PoE Managed Injector Hub is currently.

4.3.3 NTP Configuration

This section provides the NTP Configuration of Ultra PoE Managed Injector Hub as the screen in [Figure 4-3-3](#) appears and [Table 4-3-3](#) describes the NTP Configuration object of Ultra PoE Managed Injector Hub.

Time Zone Setting

Current Time:	YYYY 2016 MM 5 DD 27 Hr 15 Min 36 Sec 46
Enable NTP Client Update	<input type="checkbox"/>
Time Zone Select	(GMT+08:00)Taipei
NTP Server	<input checked="" type="radio"/> 69.164.194.139 - North America <input type="radio"/> (Manual IP Setting)

Figure4-3-3: NTP Configuration Web Page Screen

Object	Description
• Current Time	Allow input current time information of Ultra PoE Managed Injector Hub.
• Enable NTP Client Update	Allow disable or enable time update from NTP server of Ultra PoE Managed Injector Hub.
• Time Zone Select	Allow select the time zone according to current location of Ultra PoE Managed Injector Hub.
• NTP Server	Allow choose one list NTP server or assign one NTP server IP address manually for Ultra PoE Managed Injector Hub.
• Apply	Press this button to take effect.
• Refresh	Press this button to refresh the current Web page.

Table 4-3-3: Descriptions of the NTP Configuration Web Page Screen Objects

4.3.4 Password Setting

This section provides the Password Setting of Ultra PoE Managed Injector Hub as the screen in [Figure 4-3-4](#) appears. [Table 4-3-4](#) describes the Password Setting objects of Ultra PoE Managed Injector Hub.

Password Setting

User Name	<input type="text" value="admin"/>
Old Password	<input type="password"/>
New Password	<input type="password"/>
Confirmed Password	<input type="password"/>

Figure 4-3-4: Password Setting Web Page Screen

Object	Description
• User Name	Allows to input current User Name of Ultra PoE Managed Injector Hub.
• Old Password	Allows to input current Password of Ultra PoE Managed Injector Hub.
• New Password	Allows to input new Password of Ultra PoE Managed Injector Hub.
• Confirmed Password	Allows to input new Password again for confirmation of Ultra PoE Managed Injector Hub.
• Apply	Press this button to take effect.
• Reset	Press this button to reset password setting to default mode.

Table 4-3-4: Descriptions of the Password Setting Objects Screen.

 Note	<ol style="list-style-type: none"> 1. For security reason, please change and memorize the new password after this first setup. 2. The maximum length is 15 characters.
--	--

4.3.5 Firmware Upgrade

This section provides the firmware upgrade of Ultra PoE Managed Injector Hub as the screen in [Figure 4-3-5](#) appears.

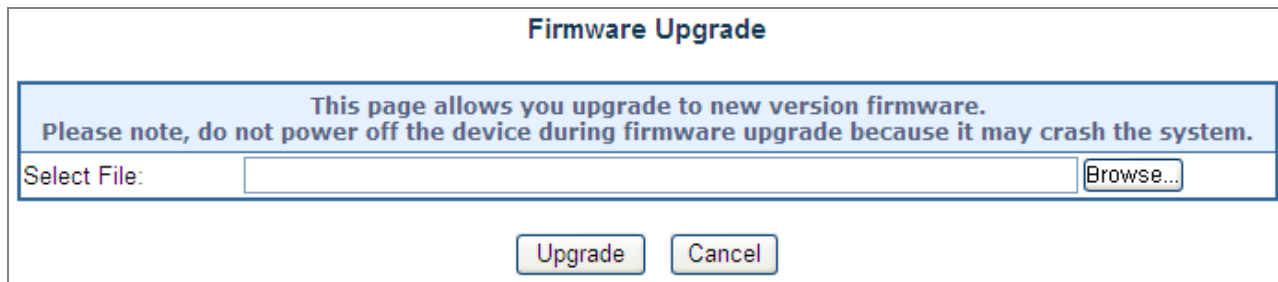

Figure 4-3-5: Firmware Upgrade Web Page Screen

Please press “**Browse**” to locate the latest firmware of Ultra PoE Managed Injector Hub that deposits in your PC. The screen in [Figure 4-3-6](#) appears.

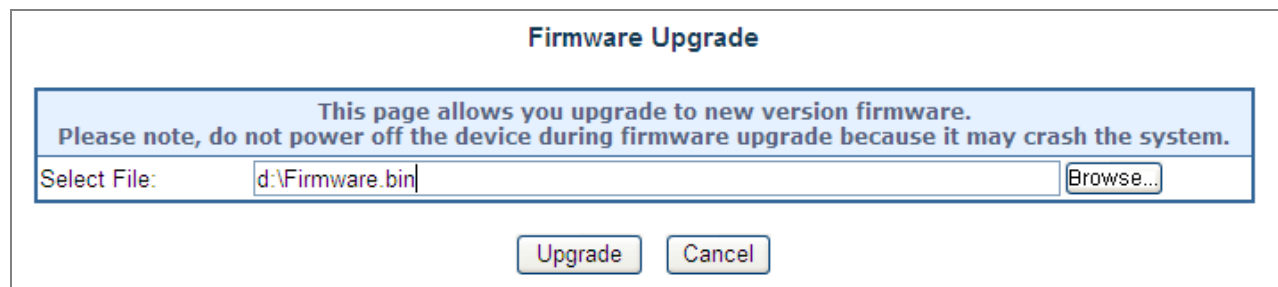

Figure 4-3-6: Firmware Upgrade Web Page Screen

Press “**Upgrade**” to start the firmware upgrade process as the screen in [Figure 4-3-7](#) appears.

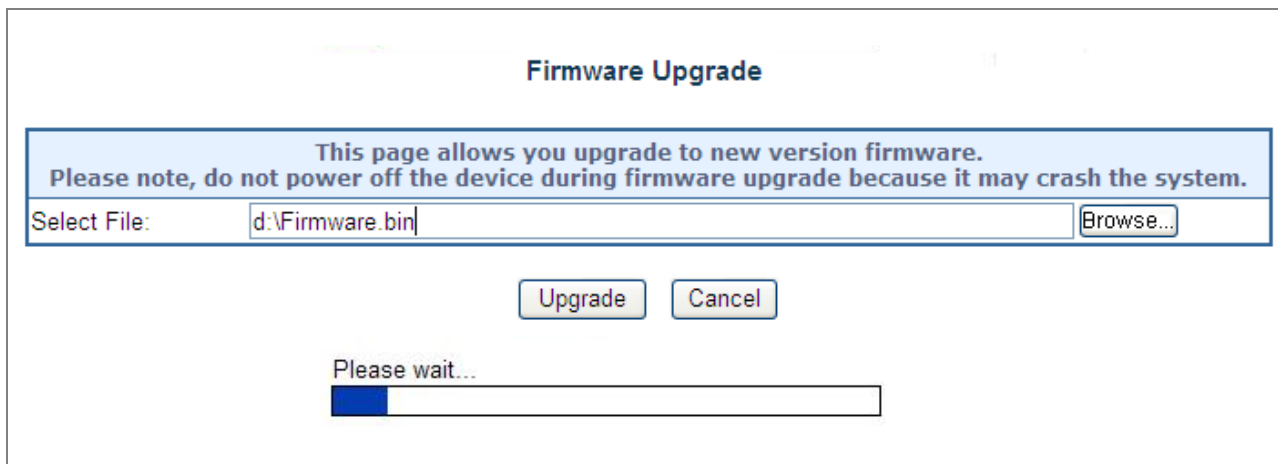

Figure 4-3-7: Firmware Upgrade Web Page Screen



1. The firmware upgrade process needs **97** seconds to complete and system will reboot automatically. After the Ultra PoE Managed Injector Hub power on is completed, the latest firmware can be used.
2. Please do not power off the Ultra PoE Managed Injector Hub during firmware upgrade process.

4.3.6 Configuration Setting

This function allows output the current Ultra PoE Managed Injector Hub configuration as a file, and upload it to other Ultra PoE Managed Injector Hub for quick multi-devices setting. The description of the procedure and screens in the following appears. The screen in [Figure 4-3-8](#) appears and [Table 4-3-5](#) describes the Configuration Setting object of Ultra PoE Managed Injector Hub.

Configuration Setting



Figure 4-3-8: Configuration Backup Screen

Object	Description
• Save Settings to File	Allow to save system configuration to a file and download to manager workstation.
• Load Settings form File	Allow to restore system configuration to Ultra PoE Managed Injector Hub.
• Browse...	Allow to specify the system configuration file locate path.
• Upload	Upload system configuration file to Ultra PoE Managed Injector Hub.

Table 4-3-5: Descriptions of the Configuration Setting Objects Screen

■ Configuration Download

All current configurations (except IP Configuration) will output as a configuration file once the “**Save**” button is pressed. Save the current configuration in manager workstation and the screen in [Figure 4-3-9](#) to [Figure 4-3-11](#) appears.

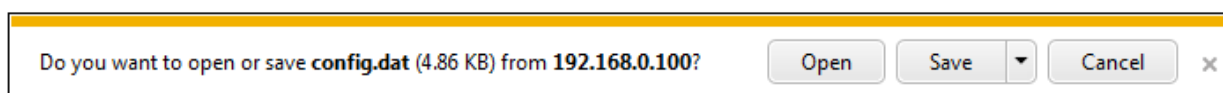

Figure 4-3-9: File Download Screen

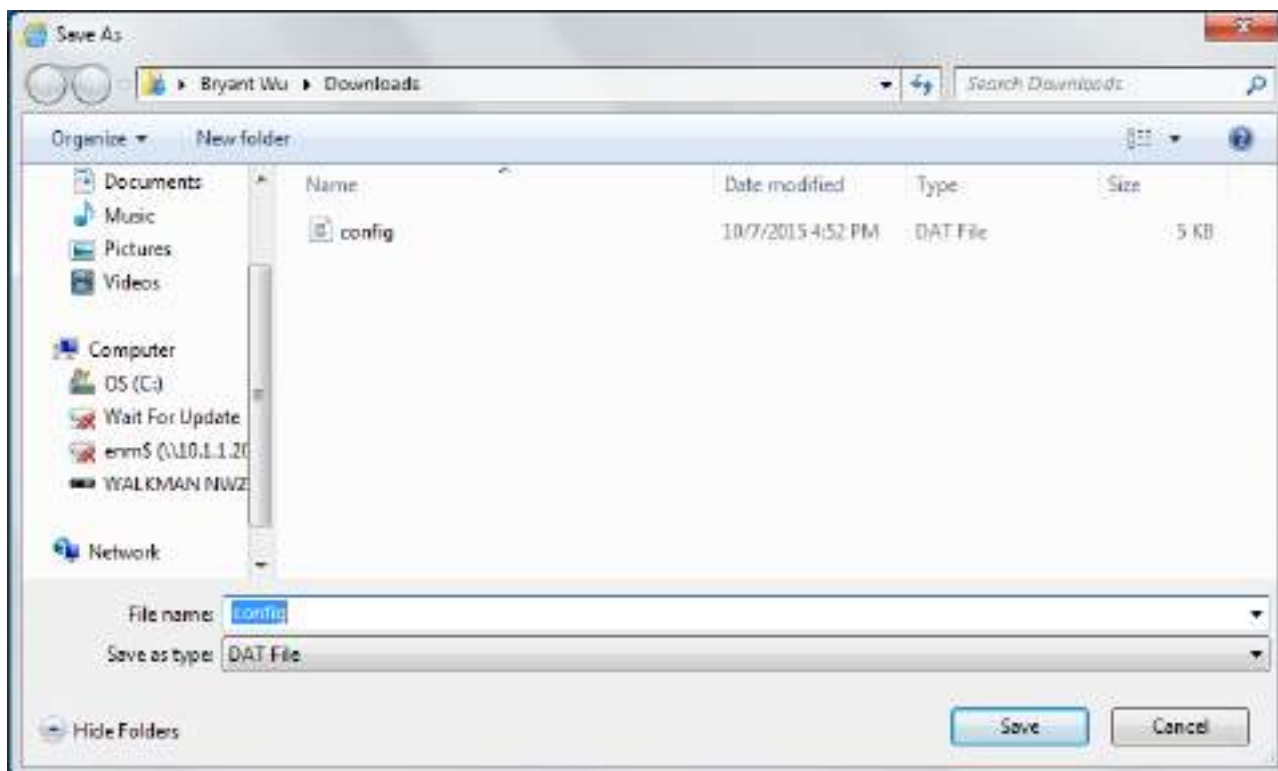

Figure 4-3-10: File Save Screen

■ Configuration Upload

Click the “**Browse**” button of the Configuration Setting Web page and the system would pop up the file selection screen to choose saved configuration. The screen in [Figure 4-3-11](#) appears.

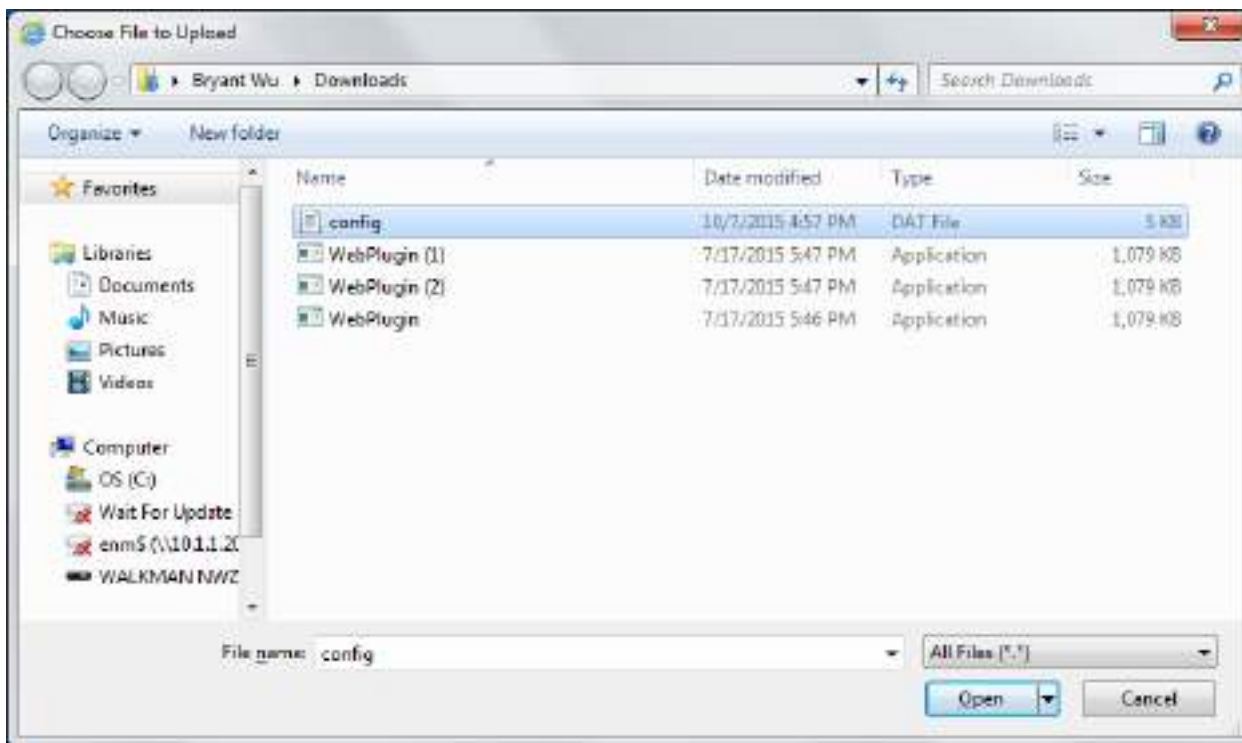

Figure 4-3-11: Windows File Selection Screen

Select on the configuration file and then click **Upload**. After system has uploaded, the screen in [Figure 4-3-12](#) appears.

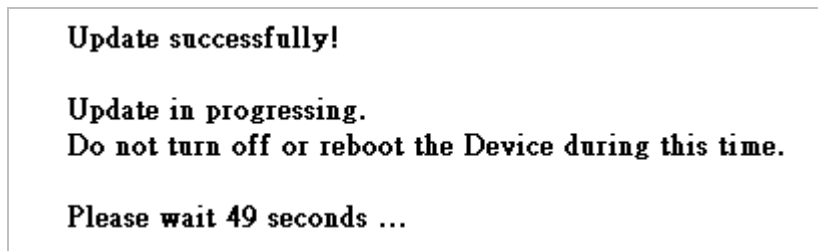

Figure 4-3-12: Configuration Upload Finished Screen

When configuration has been uploaded, please re-login the system.



Figure 4-3-13: System Login Screen

4.3.7 Factory Default

This section describes resetting the Ultra PoE Managed Injector Hub to factory default mode; the screen appears in [Figure 4-3-14](#).

Factory Default

**Press the "Reset" button will be disconnected from system and reset all configuration to factory default.
The default IP address is 192.168.0.100 and subnet mask is 255.255.255.0.**

Reset

Figure 4-3-14: Factory Default Web Page Screen

Please press the “Reset” button to take effect and the “Do you really want to reset the current settings to default?” popup window appears. Please press the “OK” button to continue the factory default process. The screen appears in Figure 4-3-15.

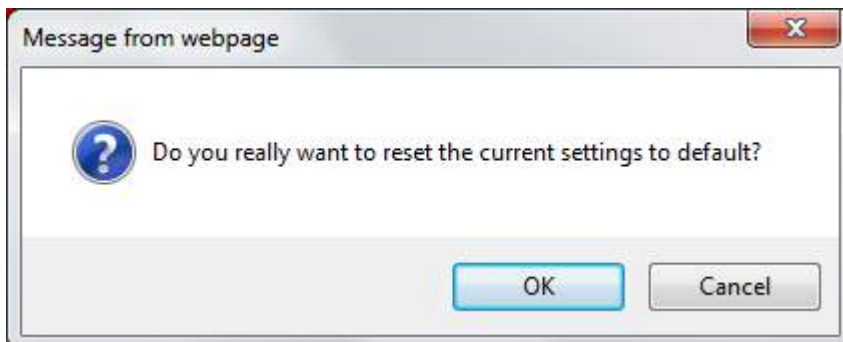

Figure 4-3-15: Factory Default Web Page Screen

Then the reboot screen appears in Figure 4-3-16 and please wait for **60 seconds** for rebooting the Ultra PoE Managed Injector Hub.

Please wait 60 seconds for rebooting

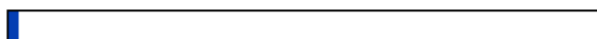

Figure 4-3-16: Factory Default Web Page Screen

After 60 seconds, the main menu Web page screen appears in Figure 4-3-17.

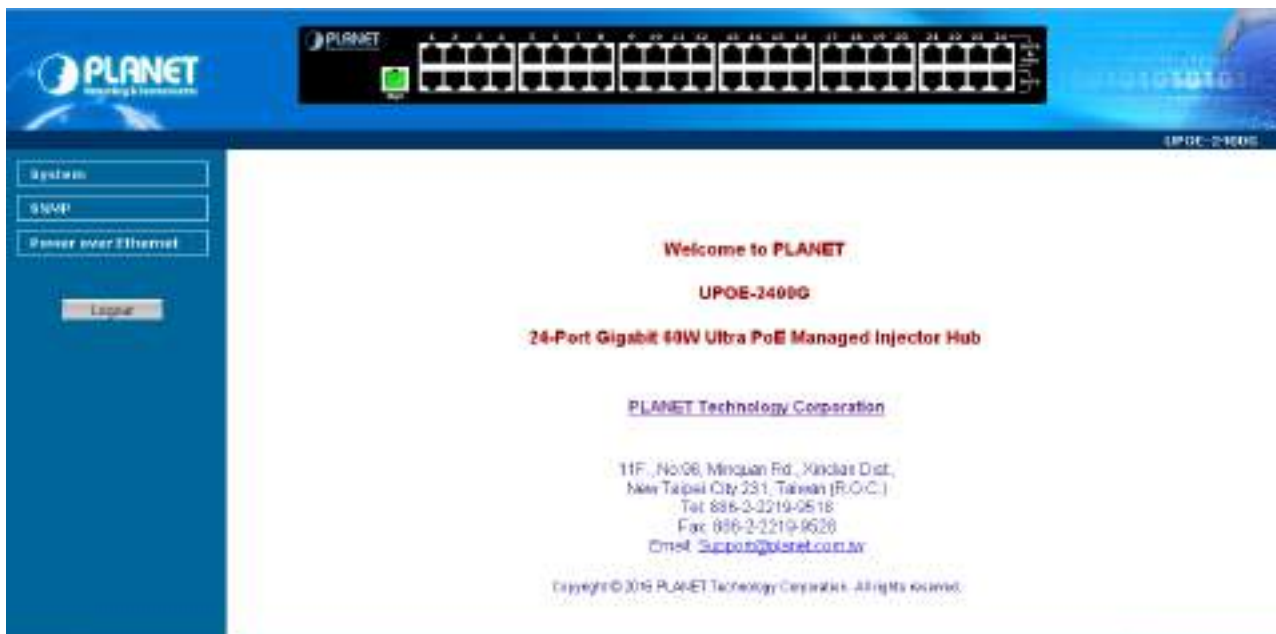

Figure 4-3-17: Main Web Page Screen

4.3.8 System Log

This section provides the system log setting and information display of Ultra PoE Managed Injector Hub as the screen in Figure 4-3-18 appears. Table 4-3-6 describes the system log setting object of Ultra PoE Managed Injector Hub.

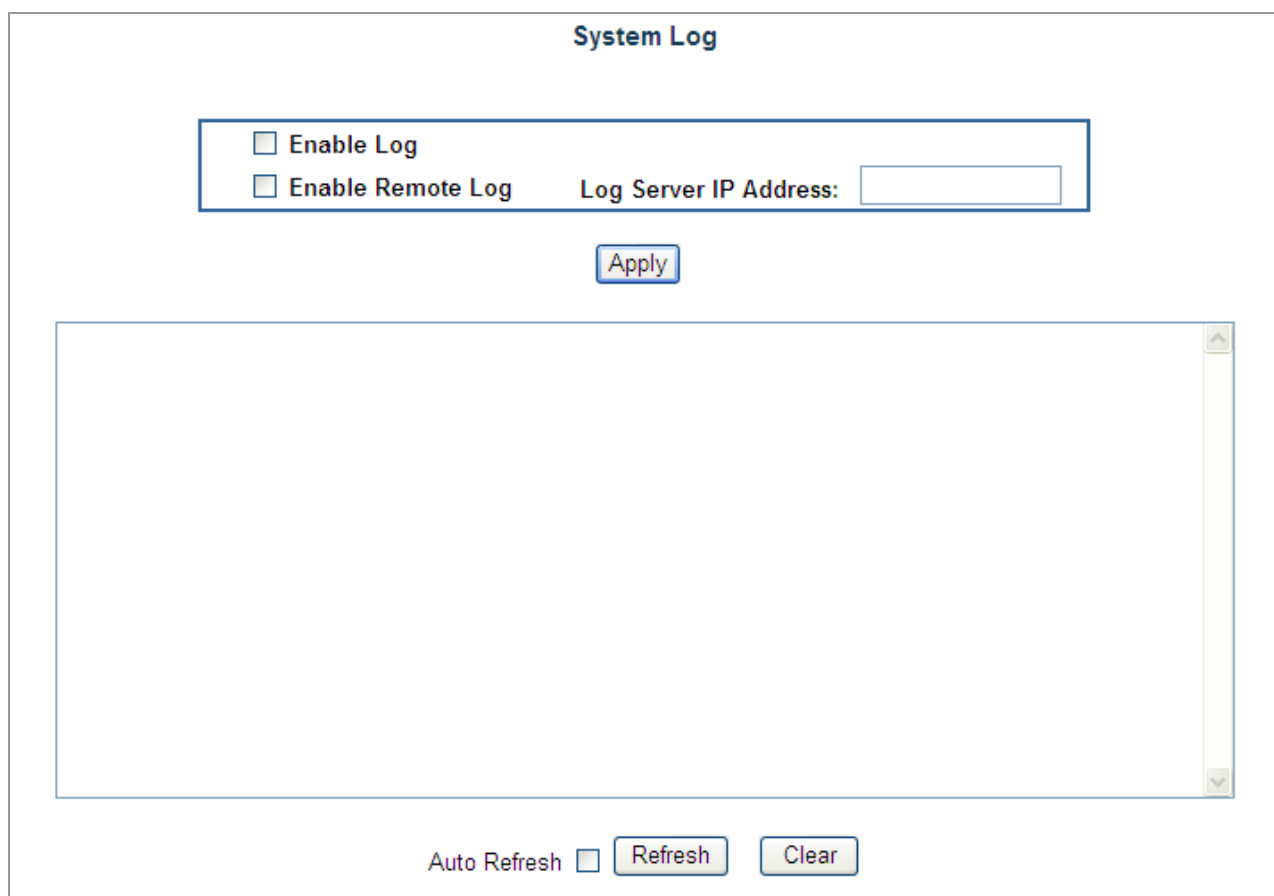

Figure 4-3-18: System Log Web Page Screen

Object	Description
• Enable Log	Disable or enable the system log function of Ultra PoE Managed Injector Hub.
• Enable Remote Log	Allow to send system log to remote log server.
• Log Server IP Address	Allow to set IP address of remote log server.
• Apply	Press this button to take effect.
• Auto-Refresh <input type="checkbox"/>	Check this box to refresh the page automatically. Automatic refresh occurs every 3 seconds.
• Refresh	Press this button to refresh current Web page.
• Clear	Press this button to clear system log information.

Table 4-3-6: Descriptions of the System Log Objects Screen

4.3.9 System Reboot

This section provides the system reboot function of Ultra PoE Managed Injector Hub as the screen in [Figure 4-3-19](#) appears.

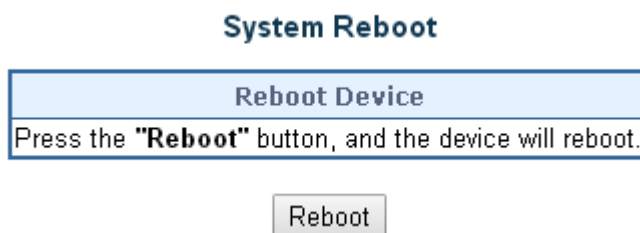

Figure 4-3-19: System Reboot Web Page Screen

Press the “**Reboot**” button to reboot the Ultra PoE Managed Injector Hub as the screen in [Figure 4-3-20](#) appears

Please wait 60 seconds for rebooting

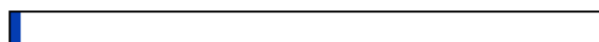

Figure 4-3-20: System Reboot Web Page Screen

Wait for **60** seconds for completing the reboot process of Ultra PoE Managed Injector Hub.

4.3.10 Logout

This section provides logout function of Ultra PoE Managed Injector Hub as the screen in [Figure 4-3-21](#) appears.

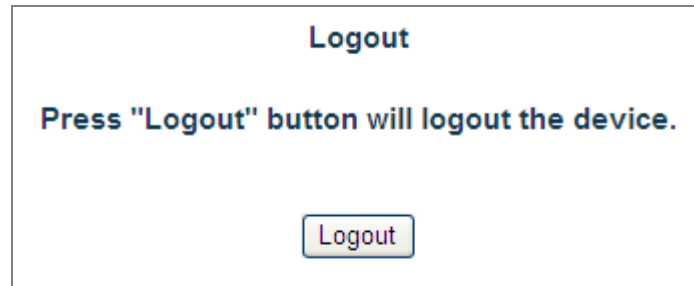

Figure 4-3-21: Logout Web Page Screen

Press the “Logout” button and then the popup window with re-login request appears as the screen in [Figure 4-3-22](#) appears.



Figure 4-3-22: Logout Web Page Screen

Please input the password for entering into Web main menu screen of Ultra PoE Managed Injector Hub as the screen in [Figure 4-3-23](#) appears.



Figure 4-3-23: Main Web Page Screen

4.4 SNMP

The Simple Network Management Protocol (SNMP) is an application layer protocol that facilitates the exchange of management information between network devices. It is part of the Transmission Control Protocol/Internet Protocol (TCP/IP) protocol suit. SNMP enables network administrations to manage network performance, find and solve network problems, and plan for network growth.

The SNMP provides SNMP Management and SNMP Trap as shown in [Figure 4-4-1](#).



Figure 4-4-1: SNMP Function Menu

The page includes the following information:

Object	Description
<ul style="list-style-type: none"> • SNMP Management 	Allow to enable or disable SNMP Agent and Trap Receiver function. It provides user to manage system information and SNMP Trap destination IP address. Explained in section 4.4.1.

Table 4-4-1: Descriptions of the System Log Objects Screen

4.4.1 SNMP Management

This section provides SNMP setting of Ultra PoE Managed Injector Hub as the screen in [Figure 4-4-2](#) appears and [Table 4-4-2](#) describes the SNMP object of Ultra PoE Managed Injector Hub.

SNMP Management

System Community	
SNMP Agent	Disable ▼
SNMP Read Community	public
SNMP Write Community	private
System Option	
System Name	UPOE-2400G
System Location	PLANET
Contact	Support@planet.com.tw
Description	PLANET 60W Ultra PoE Managed Inje
SNMP Trap Receiver Configuration	
SNMP Trap	Disable ▼
SNMP Trap Destination	192.168.0.99

Figure 4-4-2: SNMP Web Page Screen

Object	Description
<ul style="list-style-type: none"> • SNMP Agent 	Disable or enable the SNMP Agent function of Ultra PoE Managed Injector Hub.
<ul style="list-style-type: none"> • SNMP Read Community 	Allow to input characters for SNMP Read Community of Ultra PoE Managed Injector Hub. The maximum length is 30 characters.
<ul style="list-style-type: none"> • SNMP Write Community 	Allows to input characters for SNMP Write Community of Ultra PoE Managed Injector Hub. The maximum length is 30 characters.
<ul style="list-style-type: none"> • System Name 	Allows to input characters for System Name of Ultra PoE Managed Injector Hub. The maximum length is 30 characters.
<ul style="list-style-type: none"> • System Location 	Allows to input characters for System Location of Ultra PoE Managed Injector Hub. The maximum length is 30 characters.
<ul style="list-style-type: none"> • Contact 	Allows to input characters for contact of Ultra PoE Managed Injector Hub. The maximum length is 30 characters.
<ul style="list-style-type: none"> • Description 	Allows to input characters for description of Ultra PoE Managed Injector Hub. The maximum length is 30 characters.
<ul style="list-style-type: none"> • SNMP Trap 	Allows to enable or disable SNMP Trap function.
<ul style="list-style-type: none"> • SNMP Trap Destination 	Allows to send SNMP trap to an assigned workstation.

Table 4-4-2: Descriptions of the SNMP Objects Screen

4.5 Power over Ethernet

■ Power Management:

In a Power over Ethernet system, operating power is applied from a power source (PSU-power supply unit) over the LAN infrastructure to powered devices (PDs), which are connected to ports. Under some conditions, the total output power required by PDs can exceed the maximum available power provided by the PSU. The system may supervise the PSU to supply less power than the total potential power consumption of all the PoE ports in the system. In order to maintain the majority of ports activity, power management is implemented.

The PSU input power consumption is monitored by measuring voltage and current. The input power consumption is equal to the system's aggregated power consumption. The power management concept allows all ports to be active and activates additional ports, as long as the aggregated power of the system is lower than the power level at which additional PDs cannot be connected. When this value is exceeded, ports will be deactivated, according to user-defined priorities. The power budget is managed according to the following user-definable parameters: maximum available power, ports priority and maximum allowable power per port.

The Power over Ethernet provides PoE Configuration and PoE Schedule as shown in [Figure 4-5-1](#).

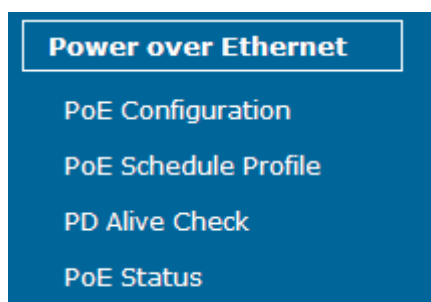

Figure 4-5-1: Power over Ethernet Function Menu

The page includes the following information:

Object	Description
• PoE Configuration	Allow to centralize management PoE power for PDs. Explained in section 4.5.1
• PoE Schedule Profile	Allow to centralize management PoE power for providing schedule. Explained in section 4.5.2.
• PD Alive Check	Allow to centralize management PoE power for checking PDs alive. Explained in section 4.5.3.
• PoE Status	Display the current PoE usage. Explained in section 4.5.4.

Table 4-5-1: Descriptions of the System Log Objects Screen

4.5.1 PoE Configuration

This section provides PoE (Power over Ethernet) Configuration and PoE output status of Ultra PoE Managed Injector Hub as screen in [Figure 4-5-2](#) appears. [Table 4-5-2](#) describes the PoE Configuration object of Ultra PoE Managed Injector Hub.

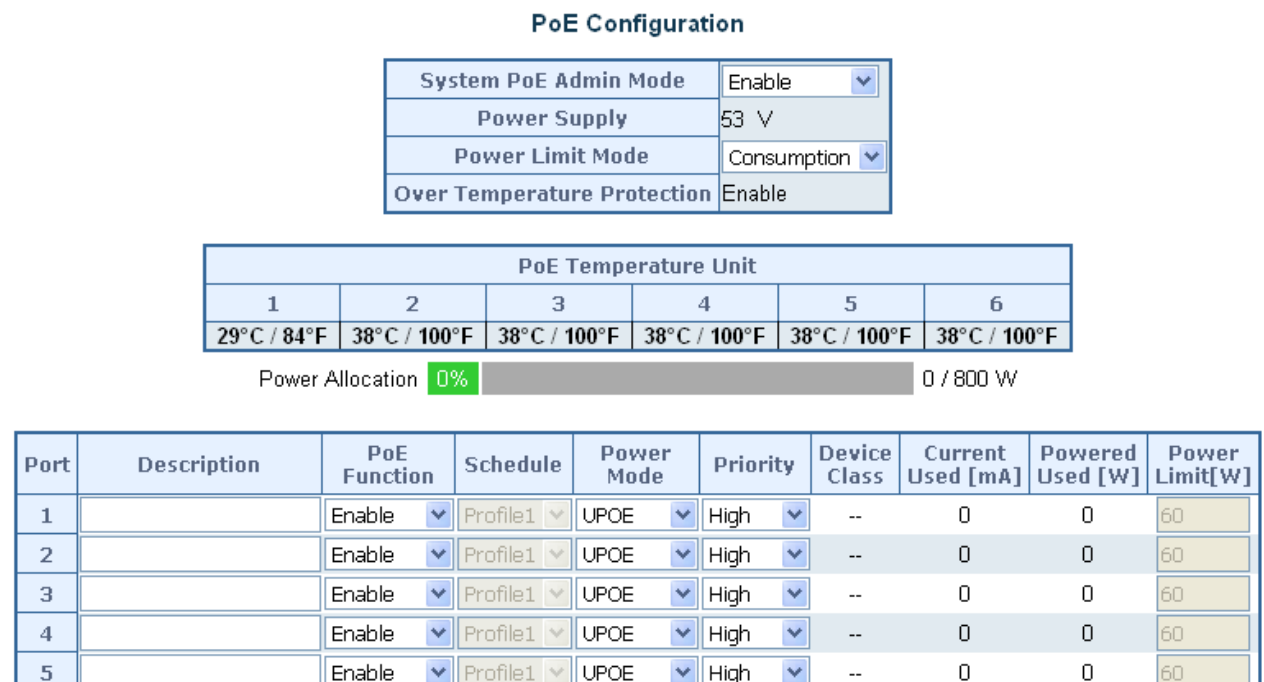

Figure 4-5-2: PoE Configuration Web Page Screen

Object	Description
• System PoE Admin Mode	Allows user to disable / enable PoE function.
• Power Supply	Displays PoE power supply status.
• Power Limit Mode	Allows user to configure power limit mode, which can be chosen. Consumption: Based on the real device power consumption where PoE power is delivered as system default setting is in this mode. Allocation: Users allow to assign how much PoE power to each port and the system will reserve PoE power to PD.
• Over Temperature Protection	Prevent system from being too hot that may cause damage. When PoE unit temperature rises over the temperature threshold value, PoE power budget will be reduced.
• PoE Temperature Unit 1	Displays the current operating temperature of PoE chip unit 1.
• PoE Temperature Unit 2	Displays the current operating temperature of PoE chip unit 2.
• PoE Temperature Unit 3	Displays the current operating temperature of PoE chip unit 3. (UPOE-1600G only)
• PoE Temperature Unit 4	Displays the current operating temperature of PoE chip unit 4. (UPOE-1600G only)
• PoE Temperature Unit 5	Displays the current operating temperature of PoE chip unit 5. (UPOE-2400G only)
• PoE Temperature Unit 6	Displays the current operating temperature of PoE chip unit 6. (UPOE-2400G only)

<ul style="list-style-type: none"> • Power Allocation 	Displays the current total power consumption status.
<ul style="list-style-type: none"> • Description 	<p>This function provides input per port description and the available letters is 30.</p> <p>NOTE: The total maximum letters are only 800. Some of special words will count as 5 per word, like ', ", \, < and >.</p>
<ul style="list-style-type: none"> • PoE Function 	Allows user to disable or enable per port PoE function, also allow choose schedule for enable PoE Schedule function of each port.
<ul style="list-style-type: none"> • Schedule 	<p>Indicates the scheduled profile mode. Possible profiles are:</p> <ul style="list-style-type: none"> ■ Profile1 ■ Profile2 ■ Profile3 ■ Profile4 <p>This function is available when choosing schedule on each port.</p>
<ul style="list-style-type: none"> • Power Mode 	<p>Allows user to select IEEE802.3at/802.3af/Ultra PoE compatibility mode. The default value is UPOE mode.</p> <p>Indicates the power inline mode. Possible profiles are:</p> <ul style="list-style-type: none"> ■ Midspan: Pins 4–5 (pair #1 in both T568A and T568B) form one side of the DC supply and pins 7–8 (pair #4 in both T568A and T568B) provide the return ■ Endspan: Pins 1–2 (pair #2 in both T568A and T568B) form one side of the DC supply and pins 3–6 (pair #3 in both T568A and T568B) provide the return ■ UPOE: Pins 1–2 (pair #2 in both T568A and T568B) form one side of the DC supply and pins 3–6 (pair #3 in both T568A and T568B) provide the return. Pins 4–5 (pair #1 in both T568A and T568B) form one side of the DC supply and pins 7–8 (pair #4 in both T568A and T568B) provide the return
<ul style="list-style-type: none"> • Priority 	<p>The Priority represents PoE ports priority. There are three levels of power priority named Low, High and Critical.</p> <p>The priority is used in case the total power consumption is over the total power budget. In this case the port with the lowest priority will be turned off, and offer power for the port of higher priority.</p>
<ul style="list-style-type: none"> • Device Class 	Displays PoE class level. The IEEE 802.3af standard offers PoE class level from 1 to 3 and IEEE 802.3at standard offers the class from 1 to 4 .
<ul style="list-style-type: none"> • Current Used [mA] 	The Power Used shows how much current the PD currently is using.
<ul style="list-style-type: none"> • Power Used [W] 	The Power Used shows how much power the PD currently is using
<ul style="list-style-type: none"> • Power Limit [W] 	It can limit the port PoE supply watts. Per port maximum value must be less than 60 watts . Total port values must be less than the Power Reservation value. Once power overload is detected, the port will auto shut down and keep in detection mode until PD's power consumption is lower than the power limit value.
<ul style="list-style-type: none"> • Apply 	Press this button to take effect.
<ul style="list-style-type: none"> • Refresh 	Press this button to refresh the current Web page.
<ul style="list-style-type: none"> • Auto-Refresh <input type="checkbox"/> 	Check this box to refresh the page automatically. Automatic refresh occurs every 3 seconds.

Table 4-5-2: Descriptions of the PoE Configuration Objects Screen

4.5.2 PoE Schedule Profile

This section provides user to configure PoE schedule and scheduled power recycling. The “**PoE schedule**” helps you to enable or disable PoE power feeding for PoE ports during specified time intervals and it is a powerful function to help SMBs or enterprises save power and money.

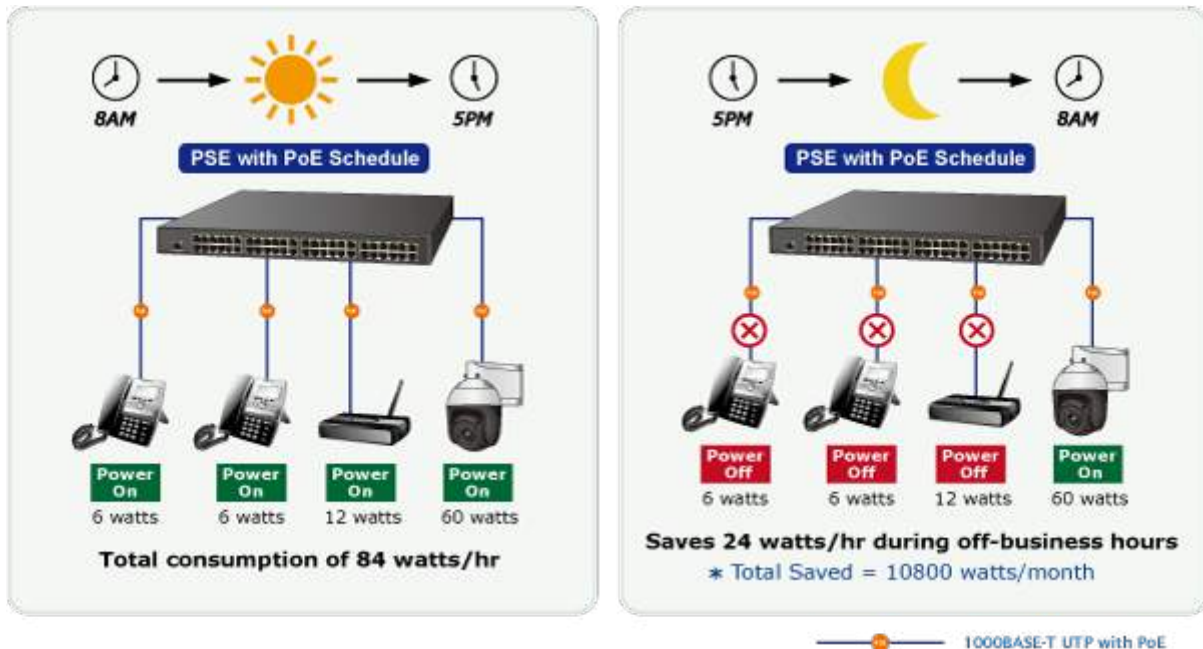

Scheduled Power Recycling

The Ultra PoE Managed Injector Hub allows each of the connected PoE IP cameras to reboot at a specified time each week. Therefore, it will reduce the chance of IP camera crash resulting from buffer overflow.

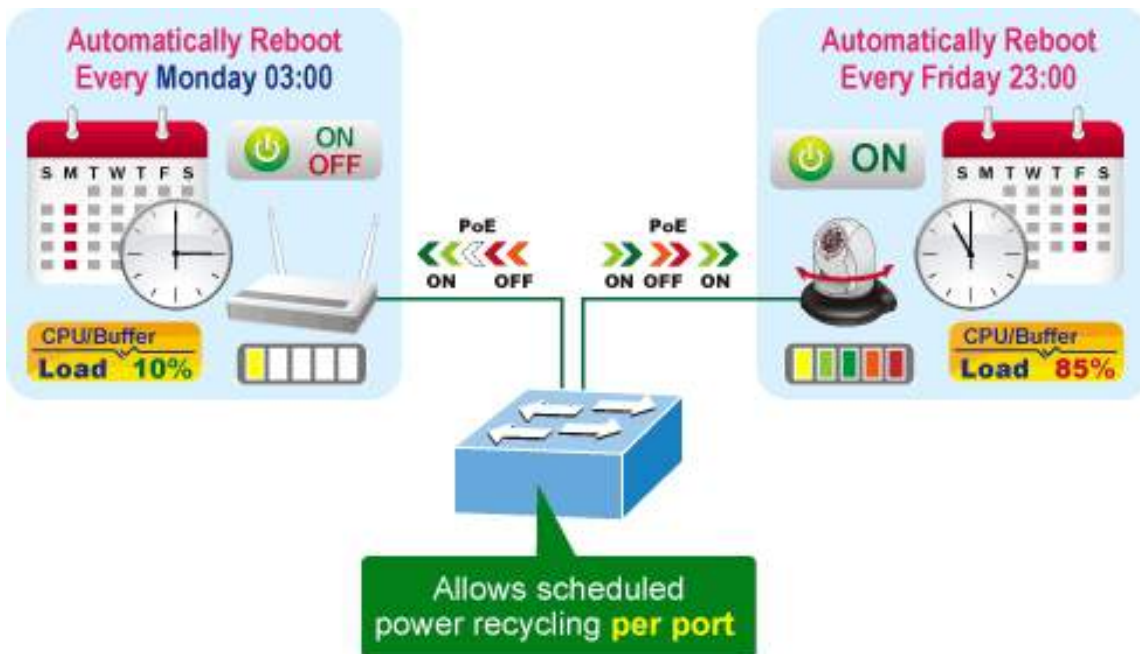

The PoE Schedule Profile Web Screens are shown in Figure 4-5-3 and Table 4-5-3.

Port	Description	PoE Function	Schedule	Power Mode	Priority	Device Class	Current Used [mA]	Powered Used [W]	Power Limit[W]
1		Schedule ▾	Profile1 ▾	UPOE ▾	High ▾	--	0	0	60
2		Schedule ▾	Profile2 ▾	UPOE ▾	High ▾	--	0	0	60
3		Schedule ▾	Profile3 ▾	UPOE ▾	High ▾	--	0	0	60
4		Schedule ▾	Profile4 ▾	UPOE ▾	High ▾	--	0	0	60
5		Schedule ▾	Profile1 ▾	UPOE ▾	High ▾	--	0	0	60
6		Schedule ▾	Profile1 ▾	UPOE ▾	High ▾	--	0	0	60
7		Schedule ▾	Profile1 ▾	UPOE ▾	High ▾	--	0	0	60
8		Schedule ▾	Profile1 ▾	UPOE ▾	High ▾	--	0	0	60
9		Schedule ▾	Profile1 ▾	UPOE ▾	High ▾	--	0	0	60
10		Schedule ▾	Profile1 ▾	UPOE ▾	High ▾	--	0	0	60
11		Schedule ▾	Profile1 ▾	UPOE ▾	High ▾	--	0	0	60

Figure 4-5-3: PoE Configuration Web Page Screen

The page includes the following information:

Object	Description
<ul style="list-style-type: none"> • PoE Function 	Allows user to disable or enable per port PoE function, also allow choose schedule for enable PoE Schedule function of each port.
<ul style="list-style-type: none"> • Schedule 	<p>Indicates the scheduled profile mode. Possible profiles are:</p> <ul style="list-style-type: none"> ■ Profile1 ■ Profile2 ■ Profile3 ■ Profile4 <p>This function available when choose schedule on each port.</p>
<ul style="list-style-type: none"> •  button 	Saves the current configuration.
<ul style="list-style-type: none"> •  button 	Refreshes the Web page and the current configuration if user doesn't save it.
<ul style="list-style-type: none"> • Auto-Refresh <input type="checkbox"/> 	Check this box to refresh the page automatically. Automatic refresh occurs every 3 seconds.

Table 4-5-3: Descriptions of the per port PoE Schedule Profile Objects Screen

PoE Schedule user can configure a duration time for PoE port as default value does not provide power; screen in [Figure 4-5-4](#) and [Table 4-5-4](#) show.

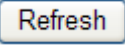
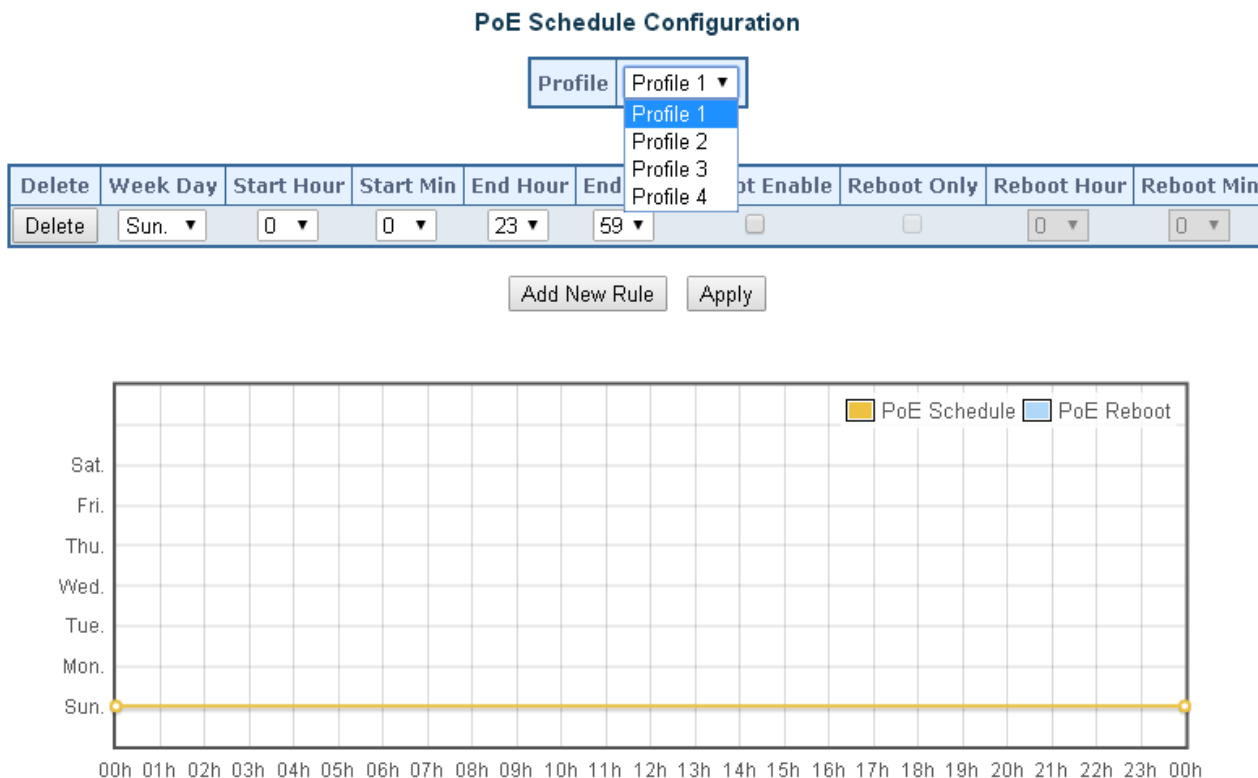

Figure 4-5-4: PoE Schedule Web Page Screen

The page includes the following information:

Object	Description
<ul style="list-style-type: none"> • Profile 	Set the schedule profile mode. Possible profiles are: Profile1 Profile2 Profile3 Profile4
<ul style="list-style-type: none"> • Delete 	Check to delete the entry.
<ul style="list-style-type: none"> • Week Day 	Allows user to set week day for defining PoE function by enabling it on the day. Sun.: Sunday Mon.: Monday Tue.: Tuesday Wed.: Wednesday Thu.: Thursday Fri.: Friday Sat.: Saturday

• Start Hour	Allows user to set what hour PoE function does by enabling it.
• Start Min	Allows user to set what minute PoE function does by enabling it.
• End Hour	Allows user to set what hour PoE function does by disabling it.
• End Min	Allows user to set what minute PoE function does by disabling it.
• Reboot Enable	Allows user to enable or disable the whole PoE port reboot by PoE reboot schedule. Please note that if you want PoE schedule and PoE reboot schedule to work at the same time, please use this function, and don't use Reboot Only function. This function offers administrator to reboot PoE device at an indicated time if administrator has this kind of requirement.
• Reboot Only	Allows user to reboot PoE function by PoE reboot schedule. Please note that if administrator enables this function, PoE schedule will not set time to profile. This function is just for PoE port to reset at an indicated time.
• Reboot Hour	Allows user to set what hour PoE reboots. This function is only for PoE reboot schedule.
• Reboot Min	Allows user to set what minute PoE reboots. This function is only for PoE reboot schedule.

Table 4-5-4: Descriptions of the PoE Schedule Configuration Objects Screen

Buttons

 : Click to add new rule.

 : Click to apply changes

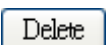
 : Check to delete the entry.

4.5.3 PoE Alive Check Configuration

The Ultra PoE Managed Injector Hub can be configured to monitor connected PD's status in real-time via ping action. Once the PD stops working and without response, the Ultra PoE Managed Injector Hub are going to restart PoE port power, and bring the PD back to work. It will greatly enhance the reliability and reduces administrator management burden.

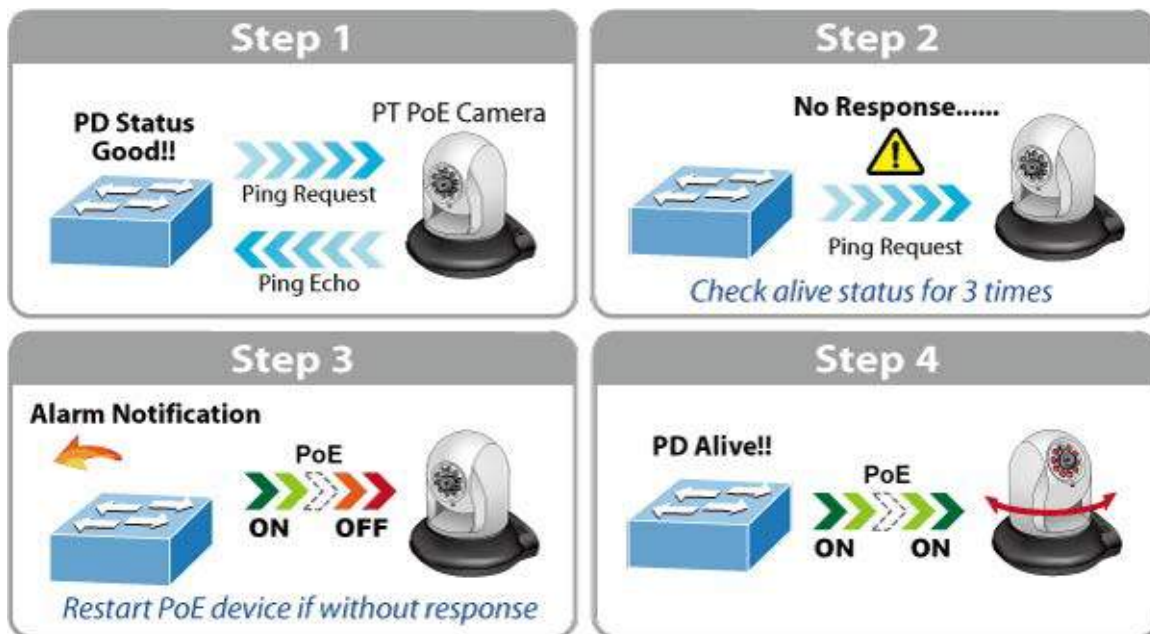

This page provides you with how to configure PD Alive Check as the screen in Figure 4-5-5 appears.

PD Alive Check

Port	Mode	Remote PD IP Address	Interval Time (10~300s)	Retry Count (1~5)	Action	Reboot Time (30~180s)
1	Enable ▾	192.168.0.10	60	2 ▾	None ▾	30
2	Enable ▾	192.168.0.20	60	2 ▾	PD Reboot ▾	60
3	Enable ▾	192.168.0.30	60	2 ▾	PD Reboot&Alarm ▾	90
4	Enable ▾	192.168.0.40	60	2 ▾	Alarm ▾	120
5	Disable ▾	192.168.0.101	60	2 ▾	None ▾	60
6	Disable ▾	192.168.0.101	60	2 ▾	None ▾	60
7	Disable ▾	192.168.0.101	60	2 ▾	None ▾	60
8	Disable ▾	192.168.0.101	60	2 ▾	None ▾	60
9	Disable ▾	192.168.0.101	60	2 ▾	None ▾	60
10	Disable ▾	192.168.0.101	60	2 ▾	None ▾	60
11	Disable ▾	192.168.0.101	60	2 ▾	None ▾	60
12	Disable ▾	192.168.0.101	60	2 ▾	None ▾	60
13	Disable ▾	192.168.0.101	60	2 ▾	None ▾	60
14	Disable ▾	192.168.0.101	60	2 ▾	None ▾	60
15	Disable ▾	192.168.0.101	60	2 ▾	None ▾	60
16	Disable ▾	192.168.0.101	60	2 ▾	None ▾	60

Apply Refresh

Figure 4-5-5: PD Alive Check Configuration Screenshot

The page includes the following fields:

Object	Description
<ul style="list-style-type: none"> • Mode 	Allows user to enable or disable per port PD Alive Check function. All ports are disabled as default value.
<ul style="list-style-type: none"> • Remote PD IP Address 	This column allows user to set PoE device IP address here for system making ping to the PoE device. Please note that the PD's IP address must be set to the same network segment as the Ultra PoE Managed Injector Hub.
<ul style="list-style-type: none"> • Interval Time (10~300s) 	This column allows user to set how long system should issue a ping request to PD for detecting whether PD is alive or dead. Interval time range is from 10 seconds to 300 seconds.
<ul style="list-style-type: none"> • Retry Count (1~5) 	This column allows user to set how many times system wants to retry ping to PD. For example, if we set count 2, the meaning is that if system retry ping to the PD and the PD doesn't response continuously, the PoE port will be reset.
<ul style="list-style-type: none"> • Action 	Allows user to set which action will be apply if the PD is without any response. The Ultra PoE Managed Injector Hub offers 3 actions as follows: <ul style="list-style-type: none"> ➢ PD Reboot: It means system will reset the PoE port that is connected to the PD. ➢ PD Reboot & Alarm: It means system will reset the PoE port and issue an alarm message via Syslog, ➢ Alarm: It means system will issue an alarm message via Syslog..
<ul style="list-style-type: none"> • Reboot Time (30~180s) 	<p>This column allows user to set the PoE device rebooting time. As there are so many kinds of PoE devices on the market, they have different rebooting times.</p> <p>The PD Alive-check is not a defining standard, so the PoE device on the market doesn't report reboots done information to the Ultra PoE Managed Injector Hub. So user has to make sure how long the PD will be finished to boot, and then set the time value to this column.</p> <p>System is going to check the PD again according to the reboot time. If you cannot make sure precise booting time, we suggest you set it longer.</p>

Buttons

 : Click to apply changes

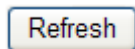
 : Refreshes the Web page and the current configuration if user doesn't save it.

4.5.4 PoE Status

This page allows user to see the usage of individual PoE Port. The screen in Figure 4-5-6 appears

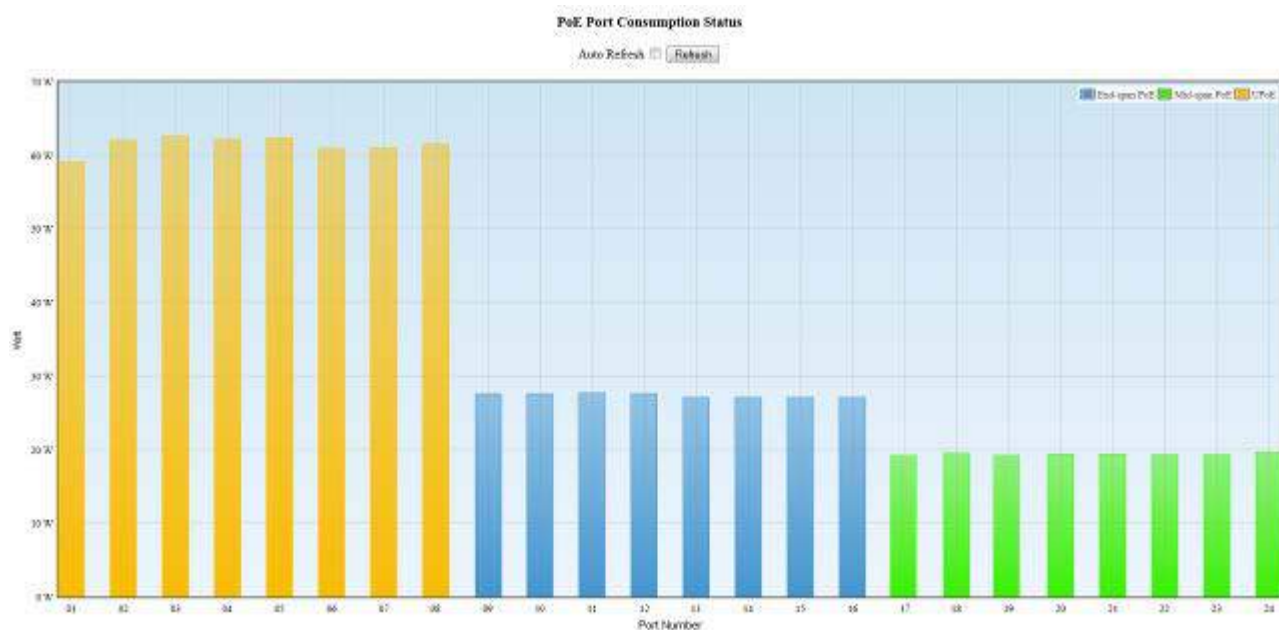





Figure 4-5-6: PoE Status Screenshot

The page includes the following fields:

Object	Description
<ul style="list-style-type: none"> • Port Number 	Displays per port status.
<ul style="list-style-type: none"> • Watt 	Displays per port PoE usage.
<ul style="list-style-type: none"> •  End-span PoE 	Indicates the end-span PoE operation mode of that port.
<ul style="list-style-type: none"> •  Mid-span PoE 	Indicates the mid-span PoE operation mode of that port.
<ul style="list-style-type: none"> •  UPoE 	Indicates the ultra PoE operation mode of that port.

Buttons

Auto Refresh : Check this box to refresh the page automatically. Automatic refresh occurs every 3 seconds.

Refresh : Refreshes the Web page and the current configuration.

5. POWER OVER ETHERNET OVERVIEW

What is PoE?

Based on the global standard IEEE 802.3af, PoE is a technology for wired Ethernet, the most widely installed local area network technology adopted today. PoE allows the electrical power necessary for the operation of each end-device to be carried by data cables rather than by separate power cords. New network applications, such as IP Cameras, VoIP Phones, and Wireless Networking, can help enterprises improve productivity. It minimizes wires that must be used to install the network for offering lower cost, and less power failures.

IEEE802.3af, also called Data Terminal equipment (DTE) power via Media dependent interface (MDI), is an international standard to define the transmission for power over Ethernet. The IEEE 802.3af also defines two types of source equipment: Mid-Span and End-Span.

■ Mid-Span

Mid-Span device is placed between legacy switch and the powered device. Mid-Span taps the unused wire pairs 4/5 and 7/8 to carry power; the other four are for data transmission

■ End-Span

End-Span device is directly connected with power device. End-Span could also tap the wire 1/2 and 3/6.

PoE system architecture

The specification of PoE typically requires two devices: the Powered Source Equipment (PSE) and the Powered Device (PD). The PSE is either an End-Span or a Mid-Span, while the PD is a PoE-enabled terminal, such as IP Phones, Wireless LAN, etc. Power can be delivered over data pairs or spare pairs of standard CAT-5e cabling.

How power is transferred through the cable

A standard Cat5e Ethernet cable has four twisted pairs, but only two of these are used for 10BASE-T, 100BASE-T and 1000BASE-T. The specification allows two options for using these cables for power as shown in [Figure 5-1-1](#) and [Figure 5-1-2](#).

The spare pairs are used. [Figure 5-1-1](#) shows the pair on pins 4 and 5 are connected together and form the positive supply, and the pair on pins 7 and 8 are connected and form the negative supply. (In fact, a late change to the spec allows either polarity to be used).

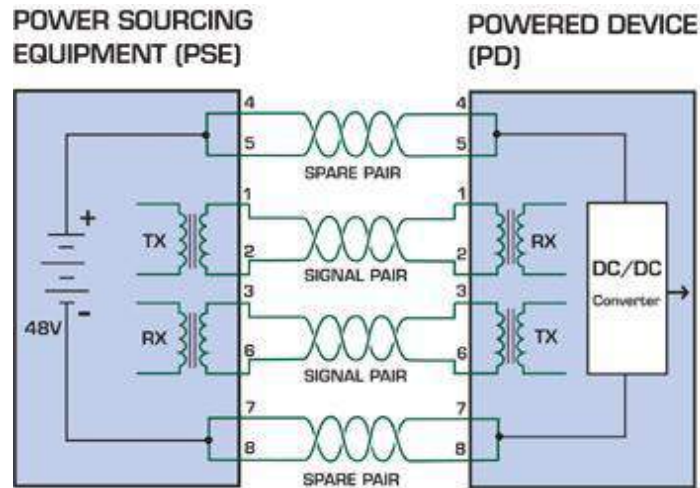

Figure 5-1-1 - Power Supplied over the Spare Pins

The data pairs are used. Since Ethernet pairs are transformer coupled at each end, it is possible to apply DC power to the center tap of the isolation transformer without upsetting the data transfer. In this mode of operation the pair on pins 3 and 6 and the pair on pins 1 and 2 can be of either polarity.

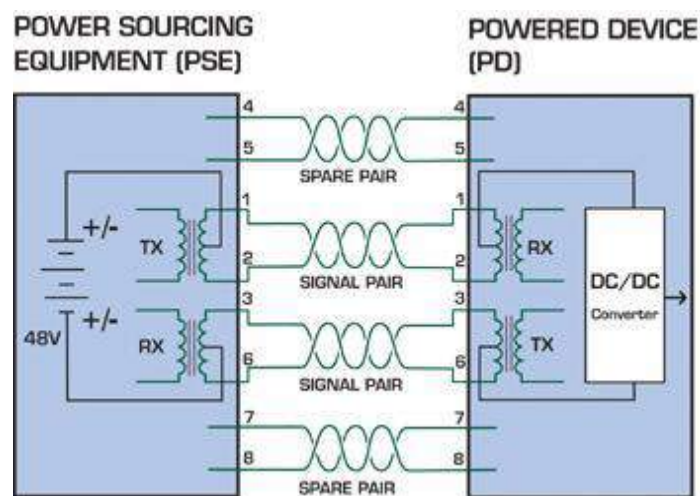

Figure 5-1-2 - Power Supplied over the Data Pins

When to install PoE?

Consider the following scenarios:

- You're planning to install the latest VoIP Phone system to minimize cabling building costs when your company moves into new office next month.
- The company staff has been clamoring for a wireless access point in the picnic area behind the building so they can work on their laptops through lunch, but the cost of electrical power to the outside is not affordable.
- Management asks for IP Surveillance Cameras and business access systems throughout the facility, but they would rather avoid another electrician's payment.

6. THE POE PROVISION PROCESS

While adding PoE support to networked devices is relatively painless, it should be realized that power cannot simply be transferred over existing Cat5e cables. Without proper preparation, doing so may result in damage to devices that are not designed to support provision of power over their network interfaces.

The PSE is the manager of the PoE process. At the beginning, only small voltage level is induced on the port's output till a valid PD is detected during the Detection period. The PSE may choose to perform classification to estimate the amount of power to be consumed by this PD. After a time-controlled start-up, the PSE begins supplying the 52V DC level to the PD till it is physically or electrically disconnected. Upon disconnection, voltage and power shut down.

Since the PSE is responsible for the PoE process timing, it is the one generating the probing signals prior to operating the PD and monitoring the various scenarios that may occur during operation.

All probing is done using voltage induction and current measurement in return.

Stages of powering up a PoE link

Stage	Action	Volts specified		Volts managed by chipset
		802.3af	802.3at	
Detection	Measure whether powered device has the correct signature resistance of 15–33 kΩ	2.7-10.0		1.8–10.0
Classification	Measure which power level class the resistor indicates	14.5-20.5		12.5–25.5
Startup	Where the powered device will start up	>42	>37.2	>38
Normal operation	Supply power to device	44-57	50-57	25.0–60.0

6.1 Line Detection

Before power is applied, safety dictates that it must first be ensured that a valid PD is connected to the PSE's output. This process is referred to as "line detection", and involves the PSE seeking a specific, 25 KΩ signature resistor. Detection of this signature indicates that a valid PD is connected, and that provision of power to the device may commence.

The signature resistor lies in the PD's PoE front-end, isolated from the rest of the PD's circuitries till detection is certified.

6.2 Classification

Once a PD is detected, the PSE may optionally perform classification, to determine the maximal power a PD is to consume. The PSE induces 15.5-25.5V DC, limited to 600 mA, for a period of 10 to 75 ms responded by a certain current consumption by the PD, indicating its power class.

The PD is assigned to one of 5 classes: 0 (default class) indicates that full 15.4 watts should be provided, 1-3 indicate various required power levels and 4 is instead of reserved has a power range of 12.95 – 25.5 watts. PDs that support classification are assigned to class 0. Special care must be employed in the definition of class thresholds, as classification may be affected by cable losses.

Classifying a PD according to its power consumption may assist a PoE system in optimizing its power distribution. Such a system typically suffers from lack of power resources, so that efficient power management based on classification results may reduce total system costs.

6.3 Start-up

Once line detection and optional classification stages are completed, the PSE must switch from low voltage to its full voltage capacity (44-57 Volts) over a minimal amount of time (above 15 microseconds).

A gradual startup is required, as a sudden rise in voltage (reaching high frequencies) would introduce noise on the data lines.

Once provision of power is initiated, it is common for inrush current to be experienced at the PSE port, due to the PD's input capacitance. A PD must be designed to cease inrush current consumption (of over 350 mA / 600mA) within 50 ms of power provision startup.

6.4 Operation

During normal operation, the PSE provides 44-57 VDC, able to support a minimum of 15.4watt / 25.5-watt power.

Power Overloads

The IEEE 802.3af / IEEE 802.3at standard defines handling of overload conditions. In the event of an overload (a PD drawing a higher power level than the allowed 12.95 watts / 25.5 watts), or an outright short circuit caused by a failure in cabling or in the PD, the PSE must shut down power within 50 to 75 milliseconds, while limiting current drain during this period to protect the cabling infrastructure. Immediate voltage drop is avoided to prevent shutdown due to random fluctuations.

6.5 Power Disconnection Scenarios

The IEEE 802.3af / IEEE 802.3at standard requires that devices powered over Ethernet be disconnected safely (i.e. power needs to be shut down within a short period of time following disconnection of a PD from an active port).

When a PD is disconnected, there is a danger that it will be replaced by a non-PoE-ready device while power is still on. Imagine disconnecting a powered IP phone utilizing 52 VDC, and then inadvertently plugging the powered Ethernet cable into a non-PoE notebook computer. What's sure to follow is not a pretty picture.

The standard defines two means of disconnection, DC Disconnect and AC Disconnect, both of which provide the same functionality - the PSE shutdowns power to a disconnected port within 300 to 400ms. The upper boundary is a physical human limit for disconnecting one PD and reconnecting another.

DC Disconnect

DC Disconnect detection involves measurement of current. Naturally, a disconnected PD stops consuming current, which can be inspected by the PSE. The PSE must therefore disconnect power within 300 to 400 ms from the current flow stop. The lower time boundary is important to prevent shutdown due to random fluctuations.

AC Disconnect

This method is based on the fact that when a valid PD is connected to a port, the AC impedance measured on its terminals is significantly lower than in the case of an open port (disconnected PD).

AC Disconnect detection involves the induction of low AC signal in addition to the 52 VDC operating voltage. The returned AC signal amplitude is monitored by the PSE at the port terminals. During normal operation, the PD's relatively low impedance lowers the returned AC signal while a sudden disconnection of this PD will cause a surge to the full AC signal level and will indicate PD disconnection.

APPENDIX A

A.1 MDI Settings

The Medium-Dependent Interface (MDI or RJ45) serves as the data/power interface between Ethernet elements. As such, it has two optional connection methods to carry the power. Named Alternative A & B, Table 1 details the two power feeding alternatives.

Pin	Alternative A	Alternative B
1	Vport Negative	
2	Vport Negative	
3	Vport Positive	
4		Vport Positive
5		Vport Positive
6	Vport Positive	
7		Vport Negative
8		Vport Negative

Table -1 Alternative Table

Delivering power through an RJ45 connector's center tap ("Phantom Feeding") guarantees that bi-directional data flow is maintained, regardless of a module's power status.

A.2 Power Device Classification Values

Class	PD Current – Classification Period [mA]	PD Power – Operation Period [W]	Note
0	0 – 4	0.44 – 12.95	Default
1	9 – 12	0.44 – 3.84	Optional
2	17 -20	3.84 – 6.49	Optional
3	26 – 30	6.49 – 12.95	Optional
4	36 - 44	12.95 - 25	Optional

A.3 DATA OUT PoE Injector RJ45 Port Pin Assignments

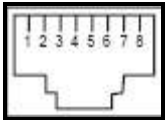
	PIN NO	10BASE-T 100BASE-TX		1000BASE-T	
	1	TX+	DC-	DA+	DC-
	2	TX-	DC-	DA-	DC-
	3	RX+	DC+	DB+	DC+
	4	-	DC+	DC+	DC+
	5	-	DC+	DC-	DC+
	6	RX-	DC+	DB-	DC+
	7	-	DC-	DD+	DC-
8	-	DC0	DD-	DC0	

A.4 RJ45 Pin Assignment of Non-802.3af/802.3at Standard PD with PoE

Mid-span PD

Pin out of Cisco non-802.3af standard PD

PIN NO	SIGNAL
1	RX+
2	RX-
3	TX+
4	VCC-
5	VCC-
6	TX-
7	VCC+
8	VCC+

Pin out of POE Mid-span

PIN NO	SIGNAL
1	RX+
2	RX-
3	TX+
4	VCC-
5	VCC-
6	TX-
7	VCC+
8	VCC+

Before you power PD, please check whether the RJ45 connector pin assignment follows IEEE 802.3af/IEEE 802.3at standard; otherwise, you may need to change one of the RJ45 connector pin assignments, which is attached with the UTP cable.