

# Z812

## 2MP 4.3x Outdoor Zoom Dome with IR LED 60m, WDR 120dB



- Weatherproof (IP68), Vandal proof (IK10), UL Listed
- H.265 Compression
- Built-in Analytics
- Event trigger, response and notification

### ► Specifications

#### Product Profile

Product Type	Zoom Dome
Application Environment	Outdoor
Maximum Resolution	2MP
Image Sensor	Progressive Scan CMOS
Sensor Size	1/2.7 "
Day / Night	Yes
Low Light Sensitivity	Superior
Minimum Illumination	Color: 0.003 lux at F1.6 (AGC on); B/W: 0 lux (IR LED on)
Mechanical IR Cut Filter	Yes
IR LED	Adaptive IR LED x 2 (850 nm)
IR Working Distance	60m
Electronic Shutter	1-1/100000 second (manual mode); 1-1/100000 second (auto mode)
S/N Ratio	75 dB

#### Lens

Focal Length	Zoom, f2.8-12mm
--------------	-----------------

Aperture	F1.6
Zoom Ratio	4.3x optical zoom
Zoom Application	Camera Installation
Iris	Fixed iris
Focus	Auto focus
Lens Mount	Board mount
Horizontal Viewing Angle	103.6° - 33.5°
Vertical Viewing Angle	56° - 18.7°
Viewing Angle Adjustment	Pan: 3°-360°, Tilt: 0°-70°, Rotation: 3°-360°

## Video

Compression	H.265 Adaptive Stream (equivalent to Zip or Smart Stream or H.265+), H.264 (Baseline/ Main/ High profile), MJPEG
Maximum Frame Rate vs. Resolution	30 fps at 1920 x 1080 30 fps at 1280 x 720 30 fps at 720 x 576 30 fps at 640 x 360
Multi-Streaming	Simultaneous dual streams
Digital Noise Reduction	2D + 3D DNR
Wide Dynamic Range	Superior WDR (120 dB)
Image Orientation	Flip, Mirror, Rotation (Corridor mode)
Image Enhancement	White Balance, Backlight compensation (BLC), Brightness, Contrast, Sharpness, Highlight compensation (HLC), Defogging
Privacy Mask	4 configurable regions
Text Overlay	Yes
Built-in Analytics	People Detection, Vehicle Detection, Tampering Detection, Object Based Motion Detection, Object Line Crossing Detection, Intrusion Detection (Forbidden Area Detection)

## Audio

Audio Type	1-way, Built-in Microphone
Audio Compression	G.711

## Network

Network Protocol & Service	IPv4, TCP, UDP, DHCP, HTTP, HTTPS, DNS, DDNS, NTP, RTP, RTSP, RTCP, RTMP, SMTP, FTP, IGMP, ICMP, ARP, UPnP, SNMP, SSL, QoS, TLS 1.2
Ethernet Port	1 x Ethernet (10/100 Base-T), RJ-45 pigtail connector
Security	IP address filtering, HTTPS encryption, Password protected user level

## Event

Event Trigger	Video motion detection (4 regions), Sound detection, Intelligent event detection
Event Response	E-mail notification with snapshots, Upload snapshot to FTP server, Save video or snapshot to storage

## Integration

Edge Recording	Support (integration with NVR by ONVIF Profile G)
----------------	---

ONVIF Compliant	Yes, Profile S, Profile G, Profile T
Web Browser	IE 11, Google Chrome, Microsoft Edge, Firefox

**Interface**

Operating Button	Reset Button
------------------	--------------

**General**

Power Source	DC 12V, PoE (IEEE802.3af)
Power Consumption	8 W (PoE)
Dimensions	( $\varnothing$ x H): 128mm x 100mm (5.0" x 3.9")
Environmental Casing	Weatherproof (IP68), Vandal proof (IK10)
Corrosion Protection	Optional for project request. Chassis corrosion resistance at the seashore approximately 2-3 years.
Operating Temperature	-40°C ~ 60°C (-40°F ~ 140°F)
Operating Humidity	10% - 95% RH, non-condensing
Surge Protection	6KV
Approvals	CE Class B, FCC Class B, IP68, IK10, UL Listed
Color	White
Real-time Clock (RTC)	No
Warranty	2 Year(s). For extended warranty offering, see <a href="http://www.acti.com/support/warranty">http://www.acti.com/support/warranty</a>

\* Edge Recording function is integrated with NVR 3 Corporate / NVR 3 Business / INR / GNR series.



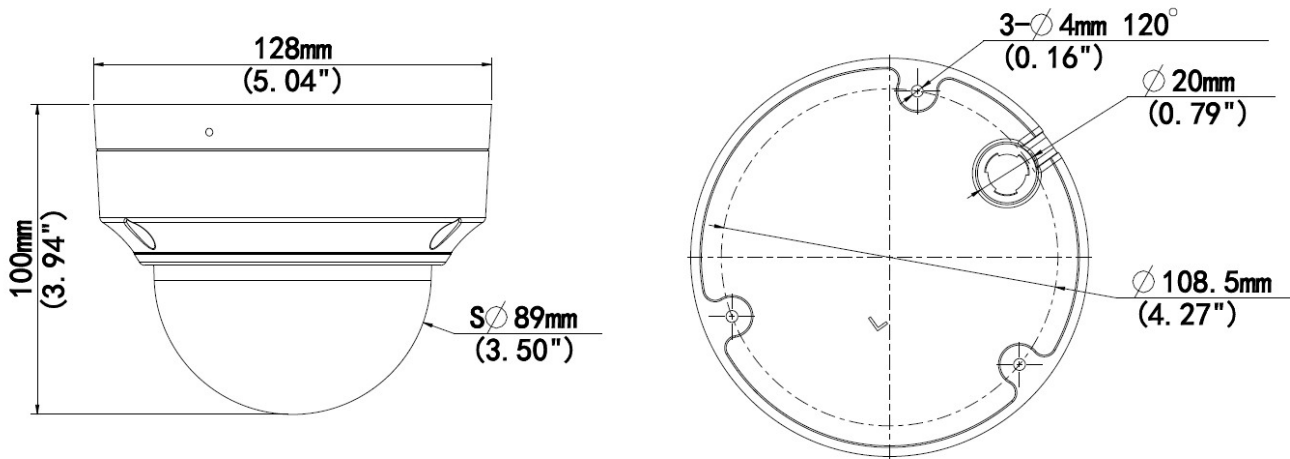



**► Dimension Diagram**



Unit: mm [inch]

## ► Related Products

### Mounting Accessories - Camera Mount

PMAX-0128		Pendant Mount (for Z5x, Z724, Z85, Z86, Z87, Z810, Z972, Q550)
PMAX-0323		Wall Mount with Built-in Junction Box (for Z9x, Z724, Z77, Z8x, Z972, A7X, Q550)
PMAX-0409		Corner Mount (for A7x, Z714, Z724, Z8x, Z9x, Z972, Q550)
PMAX-0527		Pole Mount (for Z3x, Z4x, Z5x, Z724, Z8x, Z9x, Z972, A7x, Q550), supports 2.64" to 5" Poles
PMAX-0532		Pole Mount (for Z5x, Z724, Z8x, Z9x, Z972, A7X, Q550), supports 2.6" to 5" Poles
PMAX-0713		Junction box (for Z724, Z81, Z82, Z85, Z86, Z87, Z972, Q550)

**Note:** Some mounting accessories may need additional accessories for installation. Please check [www.acti.com/mountingselector](http://www.acti.com/mountingselector) for more information.

### Dome Covers - Transparent Dome Cover

R701-70013		Z85/Z86/ Z812/Z813 Dome Cover
------------	--	-------------------------------

### Power Supply Accessories - Power Adapter

PPBX-0013		Power Adapter AC 100~240V (EU), for A3x, A4x, A88, A9x, Z31, Z8x, Z9x
PPBX-0014		Power Adapter AC 100~240V (UK), for A3x, A4x, A88, A9x, Z31, Z8x, Z9x
PPBX-0026		Power Adapter AC 100~240V (US), for A3x, A4x, A7x, A88, A9x, Z3x, Z4x, Z7x, Z8x, Z9x

### Power Supply Accessories - PoE Injector

PPOE-0107		High PoE Injector IEEE 802.3at compliant, AC 100~240V, with universal connectors (for A416, A418, B913, B923, B934, Q450, Q75, VMGB-60X, Z37, Z71, Z952)
-----------	---	--