

Z953

8MP 40x Outdoor PTZ with IR LED 250m,
WDR 145dB



- Endless Pan & Tilt, PTZ Auto Tracking

► Specifications

Product Profile

Product Type	PTZ
Application Environment	Outdoor
Maximum Resolution	8MP
Image Sensor	Progressive Scan CMOS
Sensor Size	1/1.8 "
Day / Night	Yes
Low Light Sensitivity	Superior
Minimum Illumination	Color: 0.003 lux at F1.5 (AGC on); B/W: 0 lux (IR LED on)
Mechanical IR Cut Filter	Yes
IR LED	Adaptive IR LED (850 nm)
IR Working Distance	250m
Electronic Shutter	1-1/100000 second (manual mode); 1-1/100000 second (auto mode)
S/N Ratio	75 dB

Lens

Focal Length	Zoom, f5.7-228mm
--------------	------------------

Aperture	F1.2-F4.6
Zoom Ratio	40x optical zoom, 16x digital zoom
Iris	Auto iris
Focus	Auto focus
Horizontal Viewing Angle	61.4° - 2.15°
Vertical Viewing Angle	38.8° - 1.43°

PTZ

Preset Panning / Tilting Speed	300°/second, 180°/second
Panning Range	360° endless
Tilting Range	-15°~90° (with E-flip)
PTZ Control	1024 preset points

Video

Compression	H.265 Adaptive Stream (equivalent to Zip or Smart Stream or H.265+), H.264, MJPEG
Maximum Frame Rate vs. Resolution	30 fps at 3840 x 2160 30 fps at 1920 x 1080 30 fps at 720 x 576 30 fps at 640 x 360
Bit Rate	128Kbps - 16Mbps
Multi-Streaming	Simultaneous triple streams
Digital Noise Reduction	2D + 3D DNR
Wide Dynamic Range	Extreme WDR (145 dB)
Image Enhancement	Backlight compensation (BLC), Digital Image Stabilizer (DIS, EIS), Defogging, White Balance
Privacy Mask	24 configurable regions
Text Overlay	Yes
Built-in Analytics	Deep Learning : People Counting, Crowd Detection, Tampering Detection, PTZ Auto Tracking, Object Line Crossing Detection, Object Enter Area Detection, Object Exit Area Detection, Intrusion Detection (Forbidden Area Detection)

Audio

Audio Type	2-way
Audio Compression	G.711 u-law, G.711 A-law

Network

Network Protocol & Service	IPv4, ARP, IGMP, ICMP, DHCP, DDNS, DNS, HTTP, HTTPS, FTP, IEEE 802.1X, NTP, PPPoE, QoS, RTP, TCP, RTSP, RTCP, UPnP, UDP, SMTP, SNMP, RTMP, SSL/TLS
Ethernet Port	1 x Ethernet (10/100 Base-T), RJ-45 connector
Security	HTTPS encryption, Password protected user level

Integration

ONVIF Compliant	Profile S, Profile G, Profile T
Web Browser	Microsoft Internet Explorer, Google Chrome, Firefox

Interface

Serial Port	1 x RS-485
Digital Input/Output	7/2
Operating Button	Reset Button

General

Power Source	DC 24V, AC 24V, High PoE (IEEE802.3bt)
Power Consumption	Max. 61 W
Weight	9690g (21.36lb)
Dimensions	(\varnothing x H): 270mm x 497mm (10.6" x 19.5")
Environmental Casing	Weatherproof (IP66)
Operating Temperature	-40°C ~ 70°C (-40°F ~ 158°F)
Operating Humidity	≤95% RH, non-condensing
Surge Protection	6KV
Approvals	CE, FCC
Warranty	2 Year(s). For extended warranty offering, see http://www.acti.com/support/warranty



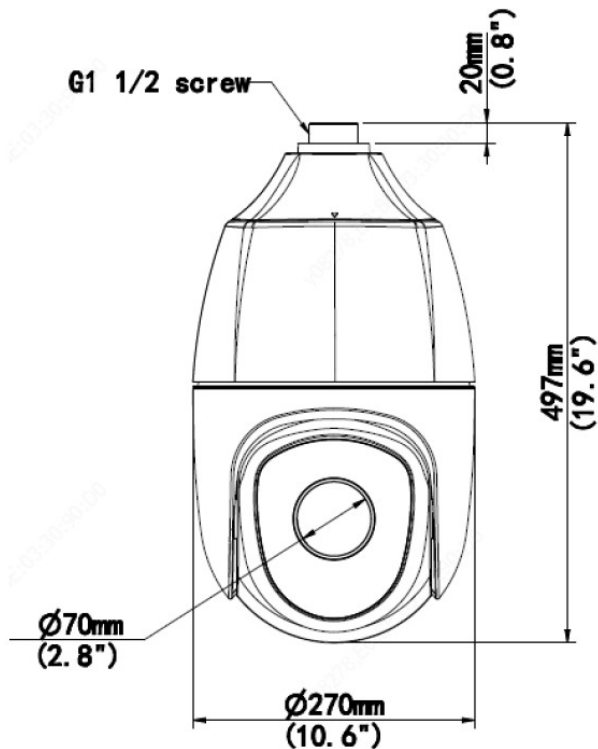





► Dimension Diagram



Unit: mm [inch]



▶ Related Products

Mounting Accessories - Camera Mount

PMAX-0115		Pendant Mount (for A950, A951, A952, A956, Z950, Z952)
PMAX-0116		Straight Tube, 200 mm (for Z950)
PMAX-0117		Straight Tube (for Z950, Z952)
PMAX-0351		Wall Mount (for Z953, Q84)
PMAX-0358		Parapet Wall Mount (for Z95X, Q84)
PMAX-0404		Corner Mount (for Z950, Z952)
PMAX-0513		Pole Mount (for Z950, Z952)
PMAX-0711		Junction box (for Z950, Z952)
PMAX-1403		Ceiling Mount (for Z950, Z952)

Note: Some mounting accessories may need additional accessories for installation. Please check www.acti.com/mountingselector for more information.

Power Supply Accessories - PoE Injector

PPOE-0201		High PoE Injector Single-port, IEEE 802.3bt Type 4, Gbps, 90W 4-Pairs POE indoor midspans, AC 100~240V, with universal connectors (for Z954, Q83)
PPOE-0202		High PoE injector 90Watt 10/100/1000M/Multi Gigabit PoE Injector (for A952, A956, Z953, Z954, Q83, Q84)