

# Z957

## 4MP Deep Learning AI LightGuard 33x Outdoor PTZ with IR LED 250m, WDR 145dB



- Weatherproof (IP66), Vandal proof metal casing (IK10), UL Listed
- Endless Pan & Tilt, PTZ Auto Tracking
- Built-in Analytics
- Event trigger, response and notification

### ► Specifications

#### Product Profile

Product Type	PTZ
Application Environment	Outdoor
Maximum Resolution	4MP
Image Sensor	Progressive Scan CMOS
Sensor Size	1/2.8 "
Day / Night	Yes
Low Light Sensitivity	Extreme
LightGuard	Yes
Minimum Illumination	Color: 0.003 lux at F1.5 (AGC on); B/W: 0 lux (IR LED on)
Mechanical IR Cut Filter	Yes
IR LED	Adaptive IR LED (850 nm)
IR Working Distance	250m
Electronic Shutter	1-1/100000 second (auto mode)
S/N Ratio	75 dB

**Lens**

Focal Length	Zoom, f4.5-148.5mm
Aperture	F1.5-F4.0
Zoom Ratio	33x optical zoom, 16x digital zoom
Iris	Auto iris
Focus	Auto focus
Horizontal Viewing Angle	51.4° - 2.5°
Vertical Viewing Angle	30.3° - 1.4°

**PTZ**

Manual Panning / Tilting Speed	0.1° - 200°/second, 0.1° - 200°/second
Preset Panning / Tilting Speed	300°/second, 240°/second
Panning Range	360° endless
Tilting Range	-15°~90° (with E-flip)
PTZ Control	Remote manual control, Speed Control, Drag to Pan and Tilt, 1024 preset points, 16 preset tours
Absolute Position	Yes

**Video**

Compression	H.265 Adaptive Stream (equivalent to Zip or Smart Stream or H.265+), H.264, MJPEG
Maximum Frame Rate vs. Resolution	30 fps at 2688 x 1520 30 fps at 1920 x 1080 30 fps at 720 x 576 30 fps at 640 x 360
Bit Rate Mode	Constant, Variable
Multi-Streaming	Simultaneous triple streams
Digital Noise Reduction	2D + 3D DNR
Wide Dynamic Range	Extreme WDR (145 dB)
Image Orientation	Flip, Mirror, Rotation (Corridor mode)
Image Enhancement	White Balance, Backlight compensation (BLC), Brightness, Sharpness, Defogging
Privacy Mask	24 configurable 3D privacy masks
Text Overlay	Yes
Built-in Analytics	Deep Learning : People Counting, Crowd Detection, Tampering Detection, PTZ Auto Tracking, Intrusion Detection (Forbidden Area Detection), Object Line Crossing Detection, Object Enter Area Detection, Object Exit Area Detection

**Analytics**

Deep Learning AI	2.0
------------------	-----

**Audio**

Audio Type	2-way, Line-in, Line-out
Audio Compression	G.711 u-law, G.711 A-law

## Network

Network Protocol & Service	IPv4/v6, TCP, UDP, DHCP, PPPoE, HTTP, HTTPS, DNS, DDNS, NTP, RTP, RTSP, RTCP, RTMP, SMTP, FTP, SFTP, IGMP, ICMP, UPnP, QoS, SNMP, IEEE 802.1X
Ethernet Port	1 x Ethernet (10/100 Base-T), RJ-45 connector
Security	IP address filtering, HTTPS encryption, Password protected user level, IEEE 802.1X network access control

## Event

Event Trigger	Video motion detection, Tampering detection, Intelligent event detection, Sound detection, External device through digital input, Video loss
Event Response	Notify control center, Go to PTZ preset point or preset tour, E-mail notification with snapshots, Save video or snapshot to storage, Upload snapshot to FTP server, Activate external device through digital output

## Integration

Unified Solution	Fully compatible with ACTi software
Edge Recording	Support (integration with NVR by ONVIF Profile G)*
ONVIF Compliant	Yes, Profile S, Profile G, Profile T
Web Browser	IE 11, Google Chrome, Microsoft Edge, Firefox

## Interface

Serial Port	1 x RS-485
Analog Video Output	1 x BNC connector
Digital Input/Output	2/1
Operating Button	Reset Button

## General

Power Source	DC 24V, AC 24V, High PoE (IEEE802.3at)
Power Consumption	25 W (PoE)
Weight	5280g (11.64lb)
Dimensions	(Ø x H): 227mm x 384.8mm (8.9" x 15.1")
Environmental Casing	Weatherproof (IP66), Vandal proof metal casing (IK10)
Corrosion Protection	Optional for project request. Chassis corrosion resistance at the seashore approximately 2-3 years.
Bundled Accessories	Power Adapter (DC 24V)
Mount Type	Wall Mount, Pole Mount, Pendant, Corner Mount
Operating Temperature	-40°C ~ 70°C (-40°F ~ 158°F)
Surge Protection	6KV
Approvals	CE Class A, FCC Class A, IP66, IK10 (metal casing), UL Listed
Color	White
Real-time Clock (RTC)	Yes
Warranty	2 Year(s). For extended warranty offering, see <a href="http://www.acti.com/support/warranty">http://www.acti.com/support/warranty</a>

\* The built-in analytics functions will be compatible with ZNR servers.



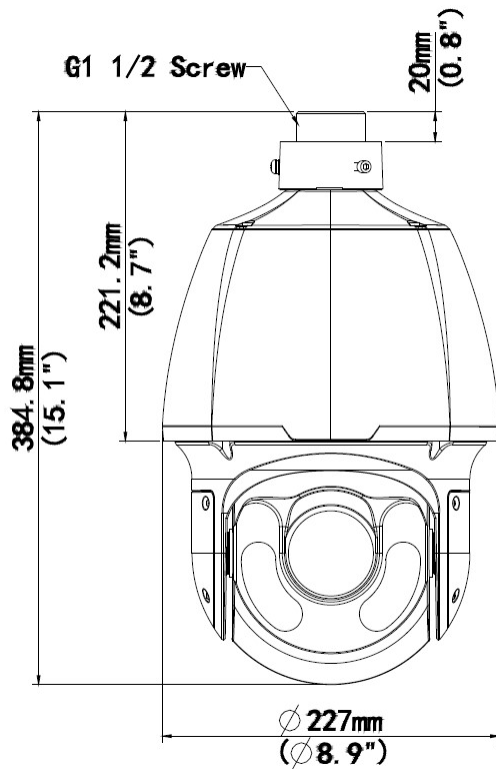



## ► Dimension Diagram













Unit: mm [inch]

## ► Related Products

### Mounting Accessories - Camera Mount

PMAX-0104		Extension Tube
PMAX-0115		Pendant Mount (for A950, A951, A952, A956, Z950, Z952)
PMAX-0116		Straight Tube, 200 mm (for Z950)
PMAX-0117		Straight Tube (for Z950, Z952)
PMAX-0126		Straight Tube with Bracket and Converter Ring (for Q75)
PMAX-0322		Wall mount (for Z950, Z952)
PMAX-0343		Gooseneck with Bracket with Converter Ring (for Q75)

PMAX-0344		Gooseneck with Converter Ring (for Q75)
PMAX-0346		Heavy Duty Wall Mount with Converter Ring (for Q75, A950, A951, A952, A956)
PMAX-0358		Parapet Wall Mount (for Z95X, Q84)
PMAX-0402		Corner Mount
PMAX-0404		Corner Mount (for Z950, Z952)
PMAX-0503		Pole Mount (for PMAx-0102, PMAx-0312, PMAx-0313, PMAx-0314, PMAx-0702, PMAx-1106, PMAx-1107), supports 5.25" to 8.5" Poles
PMAX-0513		Pole Mount (for Z950, Z952)
PMAX-0702		Junction Box for PTZ and Dome Cameras
PMAX-0711		Junction box (for Z950, Z952)
PMAX-0807		Gangbox Converter (for PMAx-0102, PMAx-0312, PMAx-0313, PMAx-0314, PMAx-0321), supports Two-Gang Boxes
PMAX-1403		Ceiling Mount (for Z950, Z952)

**Note:** Some mounting accessories may need additional accessories for installation. Please check [www.acti.com/mountingselector](http://www.acti.com/mountingselector) for more information.

### Power Supply Accessories - PoE Injector

PPOE-0107		High PoE Injector IEEE 802.3at compliant, AC 100~240V, with universal connectors (for A416, A418, B913, B923, B934, Q450, Q75, VMGB-60X, Z37, Z71, Z952)
-----------	---	--

### Audio Devices - Microphone

PMIC-0100		Active Microphone Omnidirectional for all Cameras with Line-in Audio
-----------	---	--