

# Z958

2MP 16x Outdoor PTZ with IR LED 120m,  
WDR 140dB



- Weatherproof (IP66), Vandal proof metal casing (IK10), UL Listed
- Endless Pan & Tilt, PTZ Auto Tracking
- Event trigger, response and notification
- Bundled wall mount (PMAx-0322)

## ► Specifications

### Product Profile

Product Type	PTZ
Application Environment	Outdoor
Maximum Resolution	2MP
Image Sensor	Progressive Scan CMOS
Sensor Size	1/2.8 "
Day / Night	Yes
Low Light Sensitivity	Extreme
Minimum Illumination	Color: 0.003 lux at F1.7 (AGC on); B/W: 0 lux (IR LED on)
Mechanical IR Cut Filter	Yes
IR LED	Adaptive IR LED x 6 (850 nm)
IR Working Distance	120m
Electronic Shutter	1-1/100000 second (manual mode); 1-1/100000 second (auto mode)
S/N Ratio	75 dB

### Lens

Focal Length	Zoom, f5.0-80mm
--------------	-----------------

Aperture	F1.7-F2.8
Zoom Ratio	16x optical zoom
Iris	Adaptive iris
Focus	Auto focus
Lens Mount	Board mount
Horizontal Viewing Angle	51.7° - 4.89°
Vertical Viewing Angle	30.49° - 2.75°

## PTZ

Manual Panning / Tilting Speed	0.1° - 80°/second, 0.1° - 80°/second
Preset Panning / Tilting Speed	80°/second, 80°/second
Panning Range	360° endless
Tilting Range	-15°~90° (with E-flip)
PTZ Control	Remote manual control, Speed Control, Drag to Pan and Tilt, 1024 preset points, 16 preset tours
Absolute Position	Yes

## Video

Compression	H.265 Adaptive Stream (equivalent to Zip or Smart Stream or H.265+), H.264, MJPEG
Maximum Frame Rate vs. Resolution	30 fps at 1920 x 1080 30 fps at 1280 x 720 30 fps at 720 x 576 30 fps at 640 x 360
Multi-Streaming	Simultaneous triple streams
Digital Noise Reduction	2D + 3D DNR
Wide Dynamic Range	Extreme WDR (140 dB)
Image Orientation	Flip, Mirror, Rotation (Corridor mode)(±90°, 180°)
Image Enhancement	White Balance, Backlight compensation (BLC), Highlight compensation (HLC), Automatic exposure, Brightness, Sharpness, Defogging
Privacy Mask	4 configurable regions
Text Overlay	Yes
Built-in Analytics	People Detection, Vehicle Detection, People Counting, Crowd Detection, Tampering Detection, PTZ Auto Tracking, Object Line Crossing Detection, Object Enter Area Detection, Object Exit Area Detection, Missing Object Detection, Intrusion Detection (Forbidden Area Detection)

## Network

Network Protocol & Service	IPv4, TCP, UDP, DHCP, PPPoE, HTTP, HTTPS, DNS, DDNS, NTP, RTP, RTSP, RTCP, RTMP, SMTP, FTP, IGMP, ICMP, ARP, UPnP, QoS, SSL/TLS, SNMP, IEEE 802.1X
Ethernet Port	1 x Ethernet (10/100 Base-T), RJ-45 connector
Security	IP address filtering, HTTPS encryption, Password protected user level, IEEE 802.1X network access control

## Event

Event Trigger	Video motion detection (4 regions), Video loss
---------------	--

## Event Response

Notify control center, Go to PTZ preset point or preset tour, E-mail notification with snapshots, Save video or snapshot to storage, Upload snapshot to FTP server

**Integration**

Edge Recording	Support (integration with NVR by ONVIF Profile G)*
ONVIF Compliant	Yes, Profile S, Profile G, Profile T
Web Browser	IE 11, Google Chrome, Microsoft Edge, Firefox

**Interface**

Operating Button	Reset Button
------------------	--------------

**General**

Power Source	DC 12V, High PoE (IEEE802.3at)
Power Consumption	20 W (PoE)
Dimensions	(Ø x H): 162mm x 293mm (6.4" x 11.5")
Environmental Casing	Weatherproof (IP66), Vandal proof metal casing (IK10)
Corrosion Protection	Optional for project request. Chassis corrosion resistance at the seashore approximately 2-3 years.
Bundled Accessories	Power Adapter
Mount Type	Pendant
Operating Temperature	-40°C ~ 65°C (-40°F ~ 149°F)
Surge Protection	6KV
Approvals	CE Class B, FCC Class B, IP66, IK10 (metal casing), UL Listed
Real-time Clock (RTC)	Yes
Warranty	2 Year(s). For extended warranty offering, see <a href="http://www.acti.com/support/warranty">http://www.acti.com/support/warranty</a>



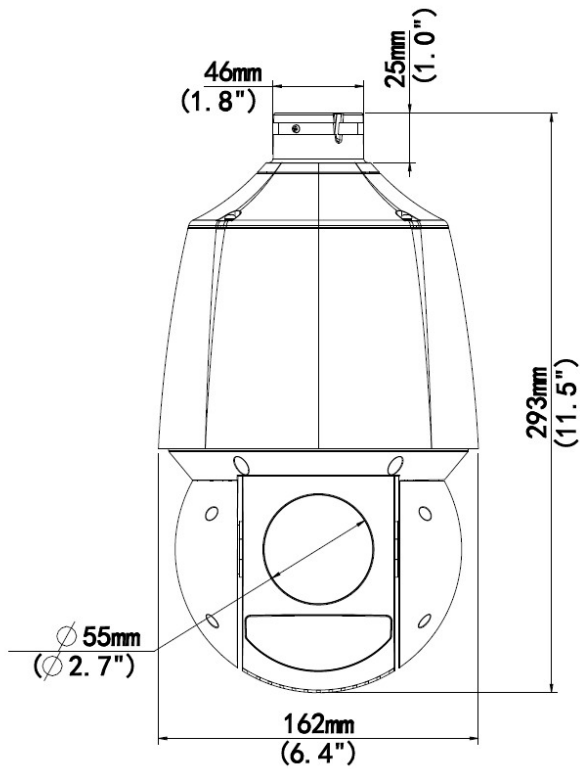



## ► Dimension Diagram













Unit: mm [inch]

## ► Related Products

### Mounting Accessories - Camera Mount

PMAX-0104		Extension Tube
PMAX-0115		Pendant Mount (for A950, A951, A952, A956, Z950, Z952)
PMAX-0116		Straight Tube, 200 mm (for Z950)
PMAX-0117		Straight Tube (for Z950, Z952)
PMAX-0126		Straight Tube with Bracket and Converter Ring (for Q75)
PMAX-0322		Wall mount (for Z950, Z952)
PMAX-0343		Gooseneck with Bracket with Converter Ring (for Q75)

PMAX-0344		Gooseneck with Converter Ring (for Q75)
PMAX-0346		Heavy Duty Wall Mount with Converter Ring (for Q75, A950, A951, A952, A956)
PMAX-0358		Parapet Wall Mount (for Z95X, Q84)
PMAX-0402		Corner Mount
PMAX-0404		Corner Mount (for Z950, Z952)
PMAX-0503		Pole Mount (for PMAx-0102, PMAx-0312, PMAx-0313, PMAx-0314, PMAx-0702, PMAx-1106, PMAx-1107), supports 5.25" to 8.5" Poles
PMAX-0513		Pole Mount (for Z950, Z952)
PMAX-0702		Junction Box for PTZ and Dome Cameras
PMAX-0711		Junction box (for Z950, Z952)
PMAX-0807		Gangbox Converter (for PMAx-0102, PMAx-0312, PMAx-0313, PMAx-0314, PMAx-0321), supports Two-Gang Boxes
PMAX-1403		Ceiling Mount (for Z950, Z952)

**Note:** Some mounting accessories may need additional accessories for installation. Please check [www.acti.com/mountingselector](http://www.acti.com/mountingselector) for more information.

## Power Supply Accessories - PoE Injector

PPOE-0107		High PoE Injector IEEE 802.3at compliant, AC 100~240V, with universal connectors (for A416, A418, B913, B923, B934, Q450, Q75, VMGB-60X, Z37, Z71, Z952)
-----------	---	--