

# Z972

5MP Deep Learning AI 5x Indoor PTZ with  
IR LED 120m, WDR 145dB



- Pan & Tilt
- H.265 Compression
- Event trigger, response and notification

## ► Specifications

### Product Profile

Product Type	PTZ
Application Environment	Indoor
Maximum Resolution	5MP
Image Sensor	Progressive Scan CMOS
Sensor Size	1/2.7 "
Day / Night	Yes
Low Light Sensitivity	Superior
Minimum Illumination	Color: 0.003 lux at F1.2 (AGC on); B/W: 0 lux (IR LED on)
Mechanical IR Cut Filter	Yes
IR LED	Adaptive IR LED (850 nm)
IR Working Distance	120m
Electronic Shutter	1-1/100000 second (manual mode); 1-1/100000 second (auto mode)
S/N Ratio	75 dB

### Lens

Focal Length	Zoom, f2.7-13.5mm
--------------	-------------------

Aperture	F1.2
Zoom Ratio	5x optical zoom
Horizontal Viewing Angle	106.9° - 30.6°
Vertical Viewing Angle	56.0° - 17.7°

## PTZ

Panning Range	350°
Tilting Range	0°~90°

## Video

Compression	H.265, H.264, MJPEG
Maximum Frame Rate vs. Resolution	30 fps at 2880 x 1620 30 fps at 2560 x 1440 30 fps at 2304 x 1296 30 fps at 1920 x 1080 30 fps at 1280 x 720 30 fps at 720 x 576 30 fps at 640 x 360 30 fps at 704 x 288 30 fps at 352 x 288
Bit Rate	128Kbps - 16Mbps
Multi-Streaming	Simultaneous triple streams
Digital Noise Reduction	2D + 3D DNR
Wide Dynamic Range	Extreme WDR (145 dB)
Image Orientation	Flip
Image Enhancement	White Balance, Backlight compensation (BLC), Highlight compensation (HLC), Digital Noise Reduction
Privacy Mask	24 configurable regions
Text Overlay	Yes
Built-in Analytics	Smart Intrusion Protection, People Line Crossing Detection, People Intrusion Detection, People Enter Area Detection, People Exit Area Detection, Vehicle Line Crossing Detection, Vehicle Intrusion Detection, Vehicle Enter Area Detection, Vehicle Exit Area Detection, Tampering Detection, Missing Object Detection, Unattended Object Detection

## Analytics

Deep Learning AI	1.0
------------------	-----

## Audio

Audio Type	2-way
Audio Compression	G.711 A-law, G.711 u-law

## Network

Network Protocol & Service	ARP, DDNS, DHCP, DNS, FTP, HTTP, HTTPS, IPv4/v6, ICMP, IEEE 802.1X, IGMP, NTP, PPPoE, QoS, RTCP, RTP, RTMP, RTSP, SNMP, SMTP, SSL/TLS, SSH, TCP, UDP, UPnP
Ethernet Port	1 x Ethernet (10/100 Base-T), RJ-45 connector
Maximum User Connections	32

## Event

Event Trigger	Video motion detection, Sound detection, Tampering detection, External device through digital input
Event Response	E-mail notification with snapshots, Activate external device through digital output

**Integration**

ONVIF Compliant	Profile S, Profile G, Profile T
-----------------	---------------------------------

**Interface**

Digital Input/Output	1/1
Operating Button	Reset Button

**General**

Power Source	High PoE (IEEE802.3at), DC 12V
Power Consumption	18W
Weight	780g (1.72lb)
Dimensions	(Ø x H): 129mm x 143.6mm (5.1" x 5.7")
Mount Type	Surface, Wall Mount, Pendant, Pole Mount
Operating Temperature	-10°C ~ 50°C (14°F ~ 122°F)
Storage Temperature	-40 °C ~ 70 °C (-40 °F ~ 158 °F)
Surge Protection	4KV
Approvals	CE, FCC, UL

### ▶ Photo Indication



- 1 Reset Button
- 2 Memory Card Slot
- 3 DC 12V Power Input
- 4 Ethernet Port

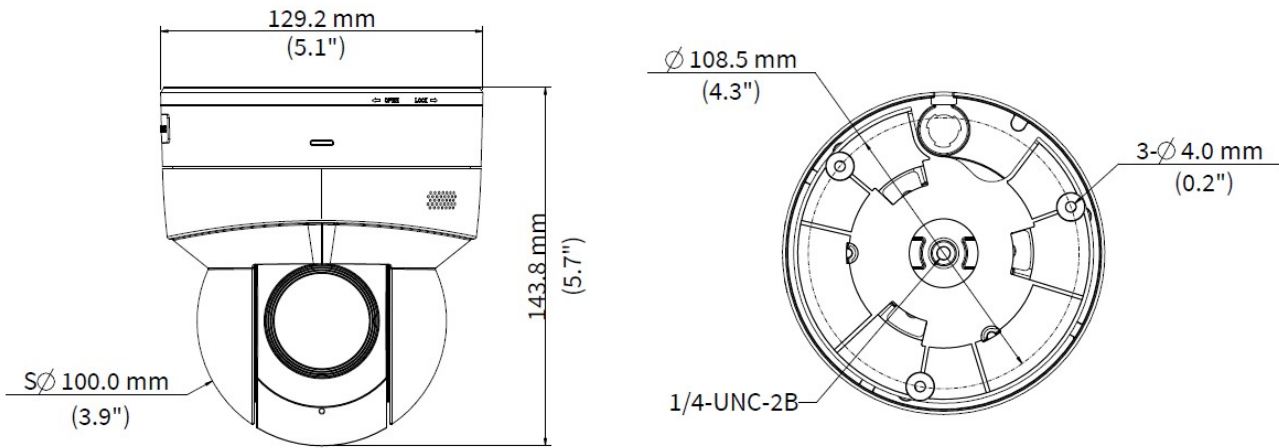

### ▶ Dimension Diagram



Unit: mm [inch]



## ▶ Related Products

### Mounting Accessories - Camera Mount

PMAX-0128		Pendant Mount (for Z5x, Z724, Z85, Z86, Z87, Z810, Z972, Q550)
PMAX-0323		Wall Mount with Built-in Junction Box (for Z9x, Z724, Z77, Z8x, Z972, A7X, Q550)
PMAX-0409		Corner Mount (for A7x, Z714, Z724, Z8x, Z9x, Z972, Q550)
PMAX-0527		Pole Mount (for Z3x, Z4x, Z5x, Z724, Z8x, Z9x, Z972, A7x, Q550), supports 2.64" to 5" Poles
PMAX-0532		Pole Mount (for Z5x, Z724, Z8x, Z9x, Z972, A7X, Q550), supports 2.6" to 5" Poles
PMAX-0713		Junction box (for Z724, Z81, Z82, Z85, Z86, Z87, Z972, Q550)

**Note:** Some mounting accessories may need additional accessories for installation. Please check [www.acti.com/mountingselector](http://www.acti.com/mountingselector) for more information.

### Power Supply Accessories - Power Adapter

PPBX-0013		Power Adapter AC 100~240V (EU), for A3x, A4x, A88, A9x, Z31, Z8x, Z9x
PPBX-0014		Power Adapter AC 100~240V (UK), for A3x, A4x, A88, A9x, Z31, Z8x, Z9x
PPBX-0023		Power Adapter 12V /2A(US) with DC PLUG for A416, A418

### Power Supply Accessories - PoE Injector

PPOE-0107		High PoE Injector IEEE 802.3at compliant, AC 100~240V, with universal connectors (for A416, A418, B913, B923, B934, Q450, Q75, VMGB-60X, Z37, Z71, Z952)
-----------	---	--