

Z98

4MP Outdoor Mini Dome with D/N, Adaptive IR, Superior WDR, SLLS, Fixed Lens



- 4 Megapixel
- Day & Night with Superior Low Light Sensitivity and Adaptive IR LED
- Fixed Lens with f2.8mm/F1.6
- Superior WDR
- H.265 Compression
- Wide Angle
- Built-in Analytics
- Event trigger, response and notification

► Specifications

Device

Product Type	Mini Dome
Maximum Resolution	4MP
Application Environment	Outdoor
Image Sensor	Progressive Scan CMOS
Sensor Size	1/3 "
Day / Night	Yes
Low Light Sensitivity	Superior
Minimum Illumination	Color: 0.003 lux at F1.6 (AGC on); BW: 0 (AGC on)
Mechanical IR Cut Filter	Yes
IR LED	Adaptive IR LED x 1 (850 nm)
IR Working Distance	40m
Electronic Shutter	1-1/100000 second (manual mode); 1-1/100000 second (auto mode)
S/N Ratio	75 dB

Lens

Focal Length	Fixed focal, f2.8mm
--------------	---------------------

Aperture	F1.6
Iris	Fixed iris
Focus	Fixed focus
Lens Mount	Board mount
Horizontal Viewing Angle	99°
Vertical Viewing Angle	53.8°
Viewing Angle Adjustment	Pan: 3°-360°, Tilt: 0°-68°, Rotation: 3°-360°

Video

Compression	H.265, H.264 (Baseline/ Main/ High profile), MJPEG
Maximum Frame Rate vs. Resolution	25 fps at 2688 x 1520 25 fps at 2560 x 1440 30 fps at 2304 x 1296 30 fps at 1920 x 1080 30 fps at 1280 x 720 30 fps at 720 x 576 30 fps at 704 x 288 30 fps at 640 x 360 30 fps at 352 x 288
Multi-Streaming	Simultaneous dual streams
Wide Dynamic Range	Superior WDR (120 dB)
Image Enhancement	Wide Dynamic Range, Backlight compensation (BLC), Brightness, Contrast, Sharpness, Automatic gain control, Defogging
Digital Noise Reduction	2D + 3D DNR
Privacy Mask	4 configurable regions
Text Overlay	Yes
Built-in Analytics	People Detection, Vehicle Detection, Tampering Detection, Object Line Crossing Detection, Intrusion Detection (Forbidden Area Detection)
Image Orientation	Flip, Mirror, Rotation (Corridor mode)

Network

Network Protocol & Service	IPv4, TCP, UDP, DHCP, PPPoE, HTTP, HTTPS, DNS, DDNS, NTP, RTP, RTSP, RTCP, SMTP, FTP, IGMP, ICMP, ARP, UPnP, SSL, SNMP
Ethernet Port	1 x Ethernet (10/100 Base-T), RJ-45 pigtail connector
Security	IP address filtering, HTTPS encryption, Password protected user level

Event

Event Trigger	Video motion detection (4 regions) Intelligent event detection
Event Response	E-mail notification with snapshots, Upload snapshot to FTP server

Integration

ONVIF Compliant	Yes, Profile S, Profile G, Profile T
Web Browser	IE 11, Google Chrome, Microsoft Edge, Firefox

Interface

Local Storage	MicroSD Memory Card Slot (card not included, up to 256GB, Kingston or Sandisk only)
Operating Button	No

General

Power Source	DC 12V, PoE (IEEE802.3af)
--------------	---------------------------

Power Consumption	5 W (PoE)
Weight	485g (1.07lb)
Dimensions	(Ø x H): 109mm x 81mm (4.3" x 3.2")
Environmental Casing	Weatherproof (IP68), Vandal proof (IK10)
Operating Temperature	-30°C ~ 60°C (-22°F ~ 140°F)
Operating Humidity	10% - 95% RH
Approvals	CE Class B, FCC Class B, IP68, IK10, UL Listed
Material	Camera body: Metal Dome Cover: Plastic
Real-time Clock (RTC)	No
Warranty	2 Year(s). For extended warranty offering, see http://www.acti.com/support/warranty

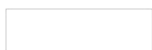

► Photo Indication

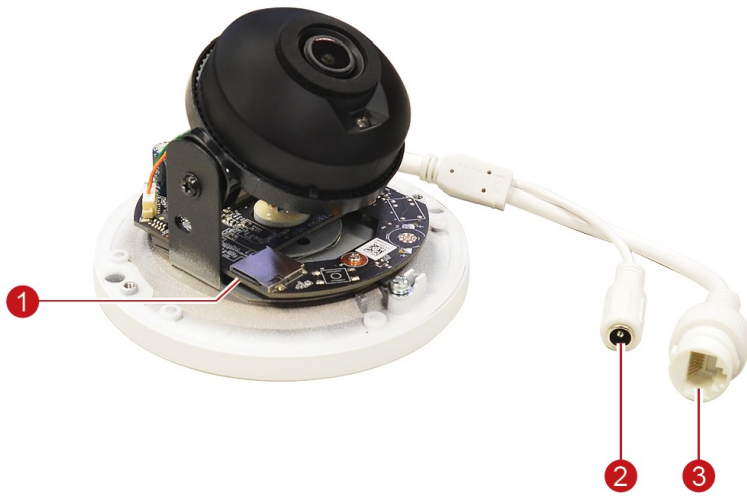

- 1 Memory Card Slot
- 2 DC 12V Power Input
- 3 Ethernet Port



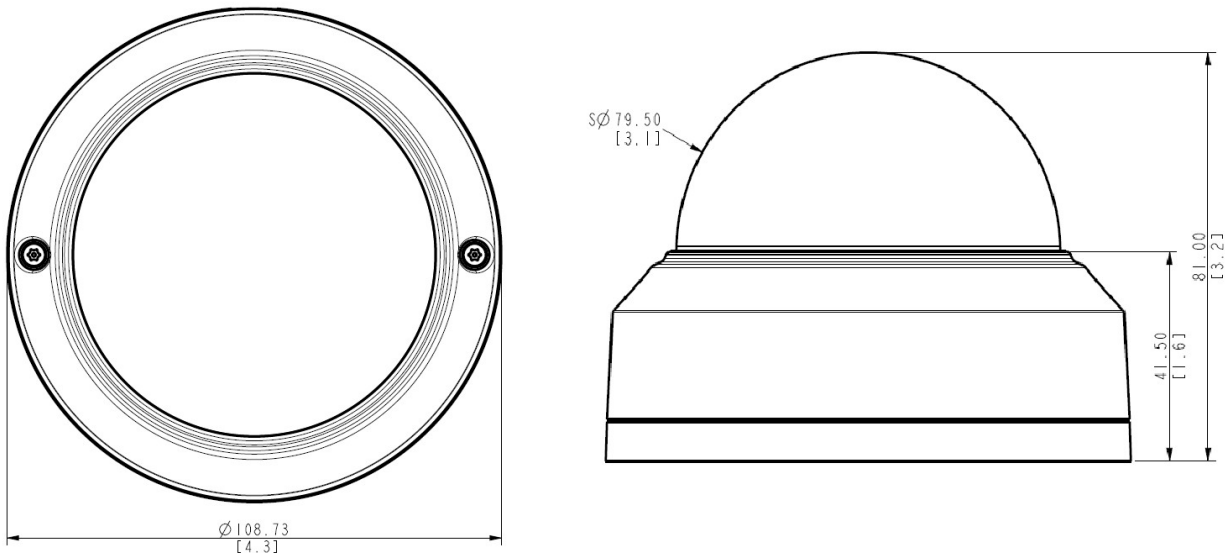











► Dimension Diagram



Unit: mm [inch]

► Related Products

Mounting Accessories - Camera Mount

PMAX-0111		Straight Tube (for D5x, D9x, E5x, E9x, E9xx/M)
PMAX-0112		Extension Tube (for D5x, D9x, E5x, E9x, E9xx/M)
PMAX-0122		Straight Tube (for A71, A88, A9x,)
PMAX-0123		Extension Tube (for A71, A88, A9x,)
PMAX-0128		Pendant Mount (for Z85, Z86, Z87, Z810)
PMAX-0318		Wall Mount (for Z91, Z97, Z98, Z710, Z714, Z715, A71, A76, A77)
PMAX-0323		Wall Mount with Built-in Junction Box (for Z91, Z94, Z95, Z97, Z98, Z77, Z81, Z82, Z85, Z86, Z87, A7X)
PMAX-0506		Pole Mount (for A31, A4x, E78, E9x, E9xx), supports 2" to 3" Poles
PMAX-0527		Pole Mount (for Z4x, Z710, Z8x, Z9x, A7x), supports 2.64" to 5" Poles
PMAX-0532		Pole Mount (Z710, Z8x, Z9x, A7x), supports 2.6" to 5" Poles
PMAX-0712		Junction box (for Z91, Z92, Z94, Z95, Z97, Z98, Z714, Z77)
PMAX-0816		Converter Ring, 1.0" NPT for Third-Party Mounting Accessories, White
PMAX-0820		Gang Box Converter (for A71, A74, Z91, Z94, Z95), supports 4" Round and 4" Octagon Boxes
PMAX-1402		Mount Kit (for Z91, Z97, Z98, Z710, Z714, Z715, A71, A76, A77)

Note: Some mounting accessories may need additional accessories for installation. Please check www.acti.com/mountingselector for more information.

Power Supply Accessories - Power Adapter

PPBX-0012		Power Adapter AC 100~240V (US), for A3x, A4x, A88, A9x, Z31, Z8x, Z9x
PPBX-0013		Power Adapter AC 100~240V (EU), for A3x, A4x, A88, A9x, Z31, Z8x, Z9x
PPBX-0014		Power Adapter AC 100~240V (UK), for A3x, A4x, A88, A9x, Z31, Z8x, Z9x

PPBX-0026



Power Adapter AC 100~240V (US) for A3x, A4x, A7x, A88, A9x, Z3x, Z4x, Z7x, Z8x, Z9x

