

20MP 360° Surround View IP Camera with Video Analytics

ZN1A-4D6DTMZ67

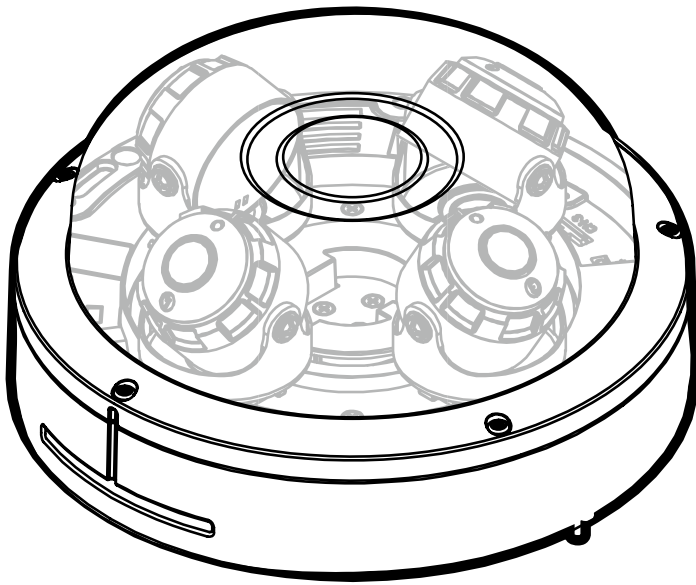

User Manual

Ver. 1.0 / 2021.04

Before connecting, operating or adjusting this product,
read this instruction booklet carefully and completely

ganzsecurity.com

Contents

NETWORK SETUP

- 03 IP Installer
- 04 Quick Start of Network Connection
- 05 DDNS Registration
- 06 Guide to Network Environment
- 07 Setup Case (A~D)
- 09 Port Forwarding
- 10 Starting IP Camera

WEB VIEWER SCREEN

- 11 Basic Screen

SETUP

- 13 Video & Audio Setup
- 21 Camera Setup
- 30 Network Setup
- 40 Trigger Action Setup
- 44 Event Setup
- 50 Record Setup
- 56 Security Setup
- 63 System Setup

APPENDIX

- 74 A : Current TCP/IP Settings
- 75 B : Changing IP address and subnet mask
- 76 C : Port Forwarding
- 78 FAQ

Network Setup - Quick Start of Network Connection

Please follow the steps below to complete the initial setup of the network function.

- i** Please do not power on the IP Camera until instructed.
- i** Temporarily disable any proxy servers configured in internet Explorer.
- i** If connecting the IP Camera directly to a modem, power down and reset the modem. Leave the modem powered down until configurations are finalized with the IP Camera and the IP Camera has been correctly connected to the modem.

1 Connect the IP Camera and PC to the configured network.

2 Open the IP Installer on a PC, then search for the IP camera.

- i** The default network type of the camera is STATIC.
- i** When set to DHCP, if you have a DHCP server, it will automatically set the Camera IP.
- i** When set to DHCP, if you have do not have a DHCP server, Camera IP is set to 192.168.xxx.xxx after one minute.

3 If multiple numbers of camera are connected it should be distinguished by the mac address of the Camera.

4 Click the Camera IP, and connect to the WEB PAGE.

5 Default ID/Password to access IP Camera are both the word: root / pass.

6 Familiarize yourself with the Viewer Interface Screen.

7 Please install VLC to display live video.

8 The IP setting can be set to 'STATIC' at IP Installer or web viewer followed by Setup -> Network -> Network Settings

9 If the IP Camera is connected to a network which utilizes a router, you must have Port Forwarding configured on your personal router to forward all ports to the IP address you have assigned the IP Camera.

10 After configuring Port Forwarding on your router (if necessary), you may access your IP Camera on your local network by opening Internet Explorer and specifying the IP address and Web Port that you have assigned to the IP Camera.

- i** Example: <http://192.168.0.200:8888>
- i** If you leave your Web Port set to 80, you don't need to specify the port in the Address Bar to access to your IP Camera.

11 Access your IP Camera via the Internet :

If you use a static IP address assigned by your ISP

- 1) Open Internet Explorer.
 - 2) Type the IP of the IP Camera.
 - 3) If you use a router, type the routers' static IP and the web port number of the IP Camera.
-

If you have a dynamic address provided by your ISP

- 1) Open Internet Explorer and visit the DDNS website.
 - 2) Register the IP Camera.
 - 3) Reboot the IP Camera.
 - 4) Give the DDNS server 10 minutes to locate your IP Camera's IP information.
 - 5) Click the refresh button in the Internet Explore.
 - 6) After your camera is connected, select your camera.
-

Network Setup - DDNS Registration

If you have DYNAMIC IP service from your Internet Service Provider (ISP), you can't tell the current IP address of the IP Camera. To solve this problem, you have to register to our DDNS service.

At first, you have to check if you are using dynamic addressing. If so, register your IP Video Server on our DDNS website before you configure, setup, or install the IP Camera.

Even though your IP is not dynamic, you will get benefit if you register to DDNS. In this case, just remember 'hostname.dyndns.com/gate1' instead of complicated series of numbers like <http://201.23.4.76:8078>.

For more details, contact our Support Center.

☒ To use a public DDNS called 'dyndns' or 'no-ip', refer to the detail information on how to use the service. (Visit the web site : <http://www.dyndns.com> or <http://www.no-ip.com>)

Network Setup - Guide to Network Environment

Please configure the IP Camera at the installation site. You must determine your network scenario in order to configure the IP Camera with the proper TCP/IP settings. This tutorial will guide you through the process. Before actually configuring the IP Camera, determine settings to be applied. Record those settings to be used to configure your IP Camera for reference.

When configuring your IP Camera, treat the IP Camera as another PC on your network. You will assign it several addresses and other TCP/IP properties to match your current network.

This step-by-step tutorial will teach what IP addresses and network configurations should be assigned based on the network scenario.

- 1 Before you begin, locate any information and settings received from your Internet Service Provider (ISP). You may need to refer to these IP addresses at a later time during the configuration.

Current TCP/IP Settings	
IP Address	
Subnet Mask	
Default Gateway	
Primary DNS Server	
Secondary DNS Server (Option)	

Static Dynamic

- 1 If you were not given any IP addresses or the ISP was responsible for the setup and installation of your Internet connection, go to step 2.
- 1 If you are not using a router on your network, your 'Current TCP/IP Settings' (from the previous section) and 'Assigned IP Addresses from My ISP' will be exactly the same.

- 2 You must determine whether the IP address is STATIC or DYNAMIC. At this moment, you are only concerned about the ISP. Did they provide you with a STATIC or DYNAMIC address? If you are unsure, contact your ISP.
- 3 Configure your IP Camera's TCP/IP settings for network connectivity by selecting Setup from the main interface and selecting TCP/IP located on the left of the Setup screen.

- 4 If prompted for ID and Password, use 'root / pass' for both entries. The default web port number is 80. If port 80 is blocked by the ISP, a value between 1025 ~ 60000 should be used. If TCP port 80 is blocked, consult the ISP.
- 5 The following descriptions are several basic network scenarios. Determine which scenario describes your network. If your network does not match one of the scenarios below and you are unsure how to setup your IP Camera, contact your network administrator and then call our Support Center.

1 You cannot control the rectangular gray areas and only the ISP has access to the devices.

Network Setup - Setup Case A, B

Case A: Dynamic IP + Personal Router [Most SOHO]

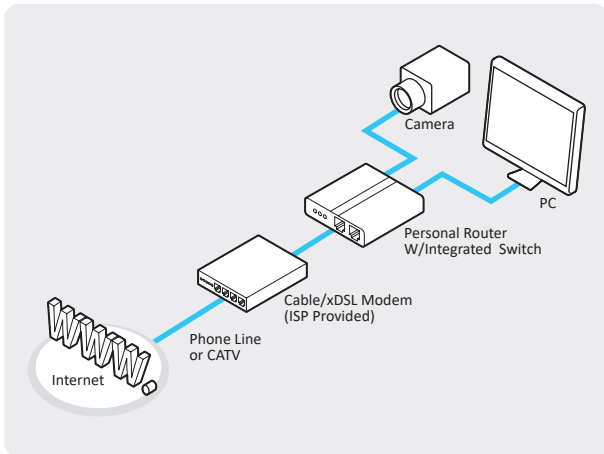

Case B: Static(Fixed) IP + Personal Router [Efficient]

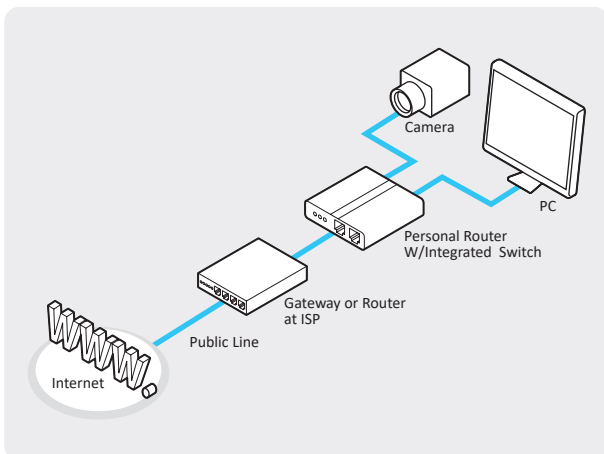

Configure your IP Camera's TCP/IP properties as follows :

1 Network Type : STATIC (even though you have Dynamic IP from your ISP, use STATIC on the IP Camera)

2 Internet Address : A private IP address such as 192.168.0.200 (Example)

1 You need to assign an IP address to the IP Camera just as you do with PC.

1 The IP address you assign must be unique to your network and match your network as well. For information on how to choose a unique IP and match your network, read the FAQ.

1 The IP address you assign must be a private IP. For information on how to choose a private IP please, read the FAQ.

3 Subnet Mask : 255.255.255.0 (Example)

1 You must use the same subnet mask as the one you noted under 'Current TCP/IP Settings'.

4 Default Gateway : 192.168.0.1 (Example)

1 This IP address must be the IP address of your router. (private or LAN side)

1 Use the same Default Gateway you noted under 'Current TCP/IP Settings'.

5 Preferred DNS Server : Use the 1st DNS Server from 'Assigned IP Address from My ISP'.

1 If you did not receive any IP addresses from your ISP, contact the ISP and acquire the IP address of their DNS server.

6 DDNS Server : Use the DDNS server.

1 This is the same site you will register later to accommodate dynamic IP from your ISP.

7 Web Port : 8888

1 Do not use the default port 80 as this number must be changed.

1 You may select any number between 1025 ~ 60000.

Network Setup - Setup Case C, D

Case C: Static(Fixed) IP [Dedicated line directly to the IP Camera]

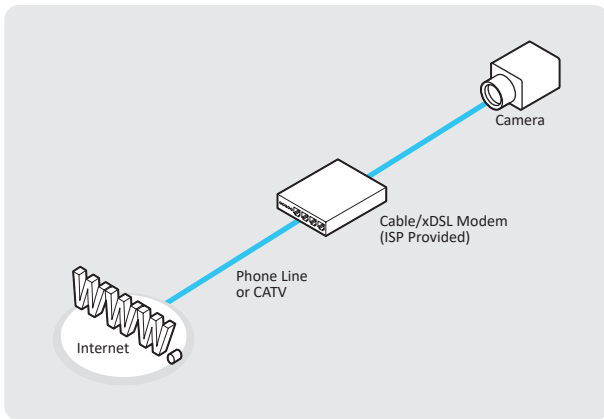

Configure your IP Camera's TCP/IP properties as follows :

- 1 Network Type : STATIC
- 2 Internet Address : A static IP address received from your ISP such as 24.107.88.125 (Example)
 - i You need to assign an IP address to the IP Camera just as you do with PC.
- 3 Subnet Mask : Subnet mask assigned from your ISP such as 255.255.255.240 (Example)
- 4 Default Gateway : 24.107.88.113 (Example)
 - i Use the assigned default gateway from your ISP.
- 5 Preferred DNS Server : Use the 1st DNS Server from 'Assigned IP Address from My ISP'
 - i If you have not received any IP addresses from your ISP, contact them to acquire the IP address of their DNS server.
- 6 DDNS Server : Use the DDNS server
 - i This is the same site you will register later to utilize our DDNS service.
- 7 Web Port : 80
 - i You may select any number between 1025 ~ 60000.

Case D: Dynamic IP + DSL/Cable Modem [Connected directly to the IP Camera]

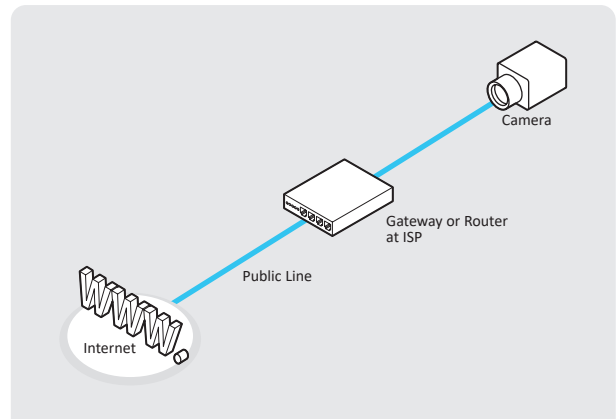

- 1 To connect the IP Camera directly to a modem, power down and reset the modem. Leave the modem powered down until configurations are finalized with the IP Camera and the IP Camera has been connected correctly to the modem. Then power on the modem, followed by the IP Camera.

Configure your IP Camera's TCP/IP properties as follows :

- 1 Network Type : DYNAMIC
- 2 DDNS Server : Use the DDNS server
 - i This is the same site you will register later to accommodate dynamic IP from your ISP.
- 3 Web Port : 80
 - i You may select any number between 1025 ~ 60000.

Network Setup - Port Forwarding

After entering the correct TCP/IP settings, you are ready for 'Port Forwarding' (Cases A, B).

- 1 Please record the TCP/IP settings of your IP Camera for future reference. You may need this information to access your IP Camera and to configure 'Port Forwarding'.

IP Camera TCP/IP Settings	
IP Address	
Subnet Mask	
Default Gateway	
Preferred DNS Server	
DDNS Server	
Web Port	

- 2 After clicking 'Apply', the system will prompt for reboot. Please allow the system 50 seconds to reboot and accept the changes. After 50 seconds, close the configuration screen. The view will display 'Trying to Reconnect'. If the ACTIVE light on the IP Camera has gone off and is now back on again flashing, the IP Camera has rebooted. After the system reboots completely, remove the power supply from the unit and close Internet Explorer.
- 3 Return your PC/Laptop TCP/IP properties to their original settings.
- 4 Before installing the IP Camera, you must use 'Port Forwarding' on your personal router (Cases A, B). You will need to forward 1 ports:
 - Web PortAll the ports will be forwarded to the IP address you assigned to the IP Camera.
In the example above, you would forward:
 - 8888 > 192.168.0.200

i For information on how to use 'Port Forwarding', please read Appendix C.

Network Setup - Starting IP Camera

After forwarding correctly the Web Port, through your router (if applicable), install the IP Camera in a proper location.

- 1 Locate the serial number located on the label attached to the bottom of the IP Camera, you will need this for DDNS registration.
- 2 Connect the IP Camera to your router or cable/DSL modem (per your network scenario) via a Cat5/5e UTP Ethernet network cable.
- 3 Supply power to the IP Camera.
- 4 After 1 minute, verify the IP Camera indicators:
 - LINK : Flickering/Solid
- 5 After configuring Port Forwarding on your computer (if necessary), access your IP Camera on your local network by opening Internet Explorer and specifying the IP address and Web Port assigned to the IP Camera.

- 1 Examples: <http://192.168.0.200:8888> or <http://24.106.88.123>
- 1 If you left your Web Port set to 80, do not need to specify the port in the Address Bar to access the IP Camera.

- 6 Access your IP Camera via the Internet :

If you use Case B, C

- 1) Open Internet Explorer.
- 2) Type the IP of the IP Camera.

If you use Case A, D

- 1) Open Internet Explorer.
- 2) Visit the DDNS website.
- 3) Register the IP Camera.
- 4) Give the DDNS server 10 minutes (MAX) to locate your IP Camera's IP information. You may reboot the server to send an immediate request to our DDNS server.
- 5) After your camera is connected, select your camera.

- 1 The difference between B and C is that B needs to set the port forwarding.
- 1 Since the type of DDNS differs from the service type, refer to the related service site.

Web Viewer Screen - Basic Screen (Default)

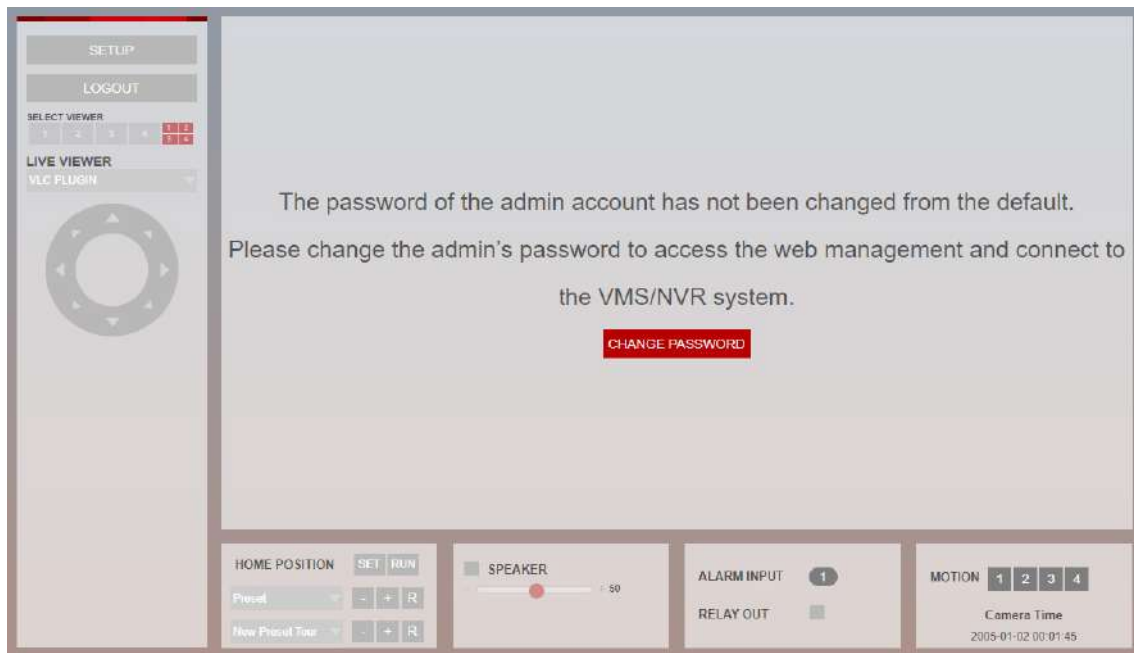

Password change is required at initial connection in factory reset state.

- 1 You can not see the image, and the Setup button is disabled.
- 2 Change the password with the CHANGE PASSWORD button.

The form is titled 'Change admin's password'. It has two input fields: 'Password' and 'Retype Password'. Below the 'Retype Password' field is a placeholder text '[Type the Password]'. A text box below the fields provides password strength guidelines: 'Weak : 8 characters or less, less than 2 combinations', 'Good : more than 8 characters, more than 3 combinations', 'Strong : more than 12 characters, 4 combinations', and '* If it is more than 'good', you can change your password.' Below this, it lists 'Combinations: uppercase letters, lowercase letters, numbers, special symbols' and 'Acceptable special characters are ~ ! \$ ^ () _ - { } [] ; : , /'. At the bottom are two buttons: 'Change Password' and 'Change Later'.

- 3 After changing the password, you must log in again by pressing the RE-LOGIN button.
Web index In the state of the page, when the web page does not have a mouse click or keyboard input event, the web session it will close and automatically switch to the log out page. (You must log in again with the RE-LOGIN button.)

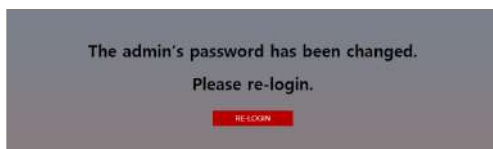

- 4 Click 'LOGOUT' to log out.

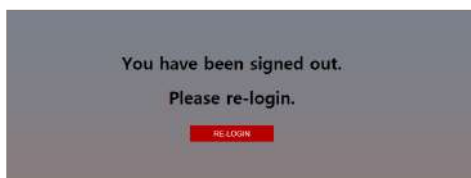

Web Viewer Screen - Basic Screen



※ Web viewer is optimized with explorer10 or above version and Firefox.

※ If VLC is not installed or VLC plugin is not supported (Chrome), Live buffering and Channel select menu on 3, 4 will be changed to Live Viewer menu, and then if HTML5(MJPEG) is selected on Live Viewer menu, then you can check the video.

1 Live video display. This is the region for live video stream from the camera.

2 Setup popup button. Click it to open the Setup page to setup details of IP camera like Video, Network, Events, System and etc. See the section 'Setup'.

3 Select Viewer. Click it to open Viewer separately and Viewer at once.

4 Channel Select button. Select a stream produced from the camera between Stream 1 ~ 3 to display it in the live view screen.

※ Refer the 'Setup > Video & Audio > Video' to setup the Video Stream.

※ If you select Viewer 1 to Viewer 4, Channelselct button is activated.

5 When the image goes unsmoothly because of bad network connection, it stored image during setup time and shows the image on the live view screen.

※ User will see the delayed images as much as setup time.

6 Below "Menu" is supported in accordance with models.

PTZ Control - This camera model does not support the zoom and focus.

Preset - Does not support.

Speaker Control - Enable/Disable Audio stream received from the camera and Volume control of the speaker in the Computer.

Alarm Input - If the alarm is triggered, the color of corresponding input number will be changed to red from dark gray.

Relay Out - Using these Checkbox, you can read status of Relay Out and also set or reset it manually.

7 **Motion** - It shows the Motion event status.

※ Event Alert Icon (1) appears if 'Motion Detection' is activated.

8 **Camera Time** - Display the camera time.

Setup - Video & Audio Setup

Video Configuration

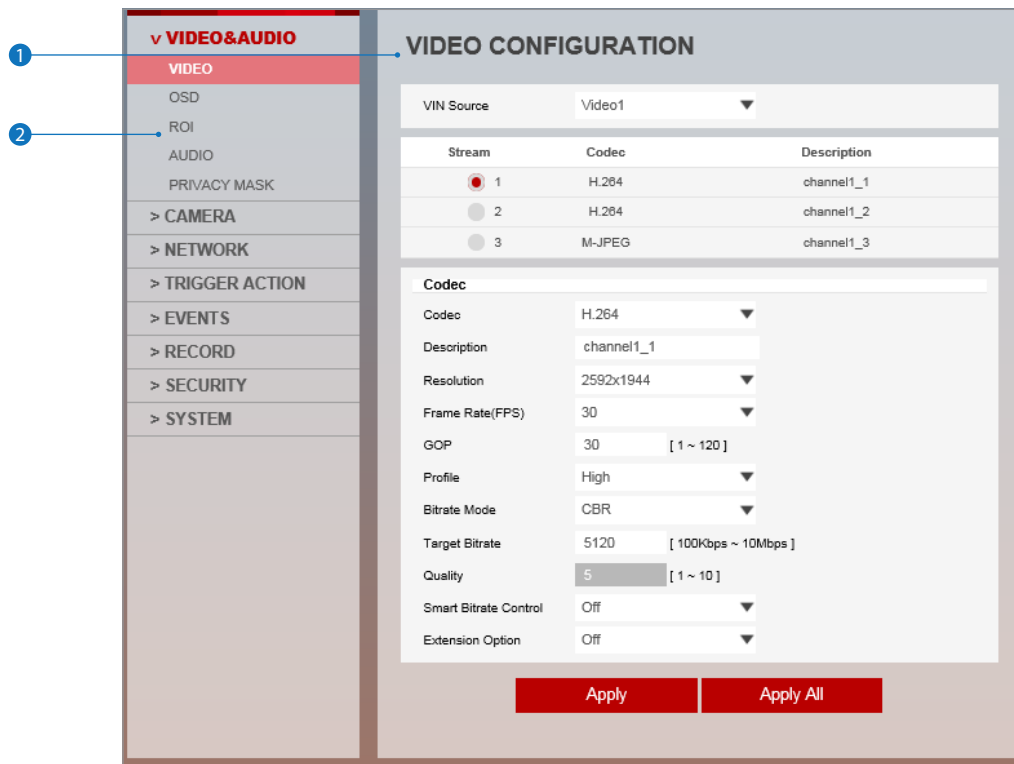

1 **Detail Page** - When you selects an item from the menu, you can set the details for the selected item.

2 **Setup Constitution**

Video&Audio

[VIDEO, OSD, ROI, AUDIO, PRIVACY MASK]

Camera

[MFZ, PROFILE, IMAGE ADJUSTMENT, EXPOSURE, DAY&NIGHT, BACKLIGHT, WHITE BALANCE, IMAGE, VIDEO]

Network

[STATUS, NETWORK SETTING, AUTO IP, ONVIF, UPNP, DDNS, FTP, SMTP, SNMP, RTSP INFORMATION]

Trigger Action

[ACTION RULES, IMAGE TRANSFER, RELAY OUT]

Events

[EVENT RULES, SCHEDULE, MOTION, TEMPERATURE, ALARM]

Record

[MANAGEMENT, RECORD LIST, STORAGE]

Security

[IP ADDRESS FILTER, RTSP AUTHENTICATION, IEEE 802.1x, HTTPS, CERTIFICATES, SERVICE]

System

[INFORMATION, DIAGNOSTICS, FIRMWARE UPDATE, DATE&TIME, DST, USER MANAGEMENT, LOG, LANGUAGE, FACTORY RESET, RESTART, OPEN SOURCE]

Setup - Video & Audio Setup

Video Configuration

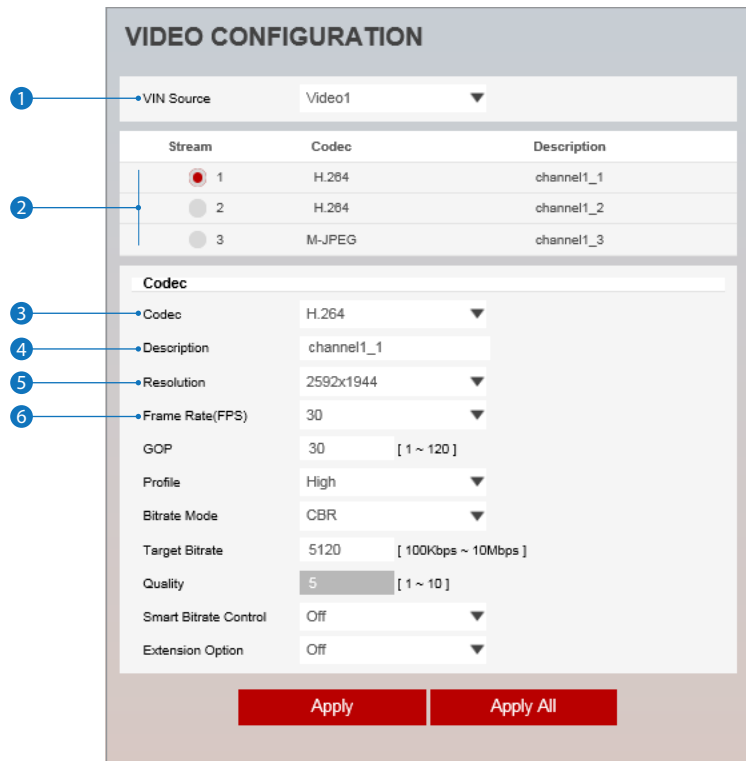

1 **VIN Source** - Select the Video 1 ~ Video 4 and set the video setup.

⚠ Click 'Apply' to set the other video setting.

2 **Live Video Channel Setup** - The video can be configured to variety settings with a combination of codec and resolution. The camera performance has to be considered when setting multiple channels. This effects on the performance of the camera.

⚠ H.265 (HEVC) codec with higher bitrate may cause the unstable live streaming or reload the webpage.

3 **Codec** - Choose the video codec. According to the selected codec, the subcategories can be changed automatically.

4 **Description** - Input the additional description about the selected channel. Max. 30 alphabets are allowed (Including space). For the description, English Alphabets, numbers and special characters (- _ @ .) can be used.

5 **Resolution** - Select the video resolution.

⚠ Available resolution can be depends on the codec setup between the channels.

<Resolution of Video Format>

QFHD	2560x1440 (4M)	1080p/i	720p/i	SVGA	768x432 (0.3M)	4CIF	VGA	640x360 (0.2M)	CIF
3840x2160	2560x1440	1920x1080	1280x720	800x600	768x432	704x576 704x480	640x480	640x360	352x288 352x240

6 **Frame Rate** - Select the maximum Frame Rate.

⚠ Available Frame Rate can be different although same codecs were set up.

Setup - Video & Audio Setup

Video Configuration

Stream	Codec	Description
<input checked="" type="radio"/> 1	H.264	channel1_1
<input type="radio"/> 2	H.264	channel1_2
<input type="radio"/> 3	M-JPEG	channel1_3

Codec

Codec: H.264
Description: channel1_1
Resolution: 2592x1944
Frame Rate(FPS): 30
GOP: 30 [1 ~ 120]
Profile: High
Bitrate Mode: CBR
Target Bitrate: 5120 [100Kbps ~ 10Mbps]
Quality: 5 [1 ~ 10]
Smart Bitrate Control: Off
Extension Option: Off

Apply Apply All

- 7 **GOP(Group of Pictures) Size** - Set up the number of frames (P-frame) which contain only changed information based on basic frame (I-frame). Regarding videos with lots of movement, if you set GOP size bigger, only the number of P-frames is bigger. As a result, video resolution will be low but 'File size' and 'Bit-rate can be decreased.

⚠ **GOP(Group of Pictures) Size is..**

I-frame and P-frame can be created for MPEG4, H.264 and H.265 (HEVC) video compression. I-frame(=key-frame) means the whole image data for one specific scene of video. P-frame is image data which has been changed information compared to I-frame GOP is made up of one I-frame and corresponding several P-frames. To improve video quality, set the number of P-frames smaller and to decrease image size, set the number of P-frames bigger.

- 8 **Profile** - The profile defines the subset of bit stream features in H.264, H.265 (HEVC) stream, including color reproduction and additional video compression.

⚠ H.264 : Main, High / H.265 (HEVC) : Main

Main - An intermediate profile with a medium compression ratio. The main profile supports I-frames, P-frames, and B-frames.

High - A complex profile with a high compression ratio. The high profile supports I-frames, P-frames, and B-frames.

- 9 **Bitrate Mode** - Select the bit rate control scheme of video compression from CBR (Constant Bit Rate) or VBR (Variable Bit Rate).

CBR - To guarantee the designated constant bit rate, the quality of video are controlled in this mode. Therefore, the quality of video is likely to be varying when network traffic is changing.

VBR - To guarantee the designated quality, the bit rate of video stream is changed in this mode. Therefore, the frame rate of video is likely to be varying when network traffic is changing.

⚠ This category won't be appear if you select the codec.

Setup - Video & Audio Setup

Video Configuration

Stream	Codec	Description
<input checked="" type="radio"/> 1	H.264	channel1_1
<input type="radio"/> 2	H.264	channel1_2
<input type="radio"/> 3	M-JPEG	channel1_3

Codec

Codec: H.264
Description: channel1_1
Resolution: 2592x1944
Frame Rate(FPS): 30
GOP: 30 [1 ~ 120]
Profile: High
Bitrate Mode: CBR

10 Target Bitrate: 5120 [100Kbps ~ 10Mbps]
11 Quality: 5 [1 ~ 10]
12 Smart Bitrate Control: Off
13 Extension Option: Off

14 Apply Apply All

10 **Target Bitrate** - If Bitrate Control is set to be CBR, you can set the Target Bitrate.

11 **Quality** - For VBR control mode, The Target Quality of video can be setup.

12 **Smart Bitrate Control**

Off - You can not use the Smart Bitrate Control function.

CVBR (Framerate priority) - This Mode is for cameras which do not want absolute any frame drop, but still want to get lower bitrate. It has limitation when the Target bitrate is set to be very low, but actual motion is big or scene is very noisy.

CVBR (Quality priority) - When the Target bitrate is set to very low, and motion is big, then LBR will try to drop frames, and make the final fps to be lower, so that it can save its and make the output frames to have better quality.

CBR - This Mode is a CBR alike mode which is close to traditional security IPCAM, and it's not designed for LBR, It's provided as an option in LBR library just to help comparison.

13 **Extension Option**

Off - You can not use the Extension Option.

SVC-T On - The H.264, H.265 (HEVC) SVC (Scalable Video Coding) is a video compression algorithm that enables effective and efficient transmission of video files over low bandwidth networks.

14 Click 'Apply' to make above setting effective.

⌘ Click 'Apply All' to set all video setting.

Setup - Video & Audio Setup

OSD Configuration

ON SCREEN DISPLAY(OSD) CONFIGURATION

1 VIN Source Video1 ▼

2 **Date & Time**
 Off On
position X 0 [0 ~ 100]
position Y 0 [0 ~ 100]

3 **User Text**
 Off On
position X 0 [0 ~ 100]
position Y 0 [0 ~ 100]
Text

4 Apply

- 1 **VIN Source** - Select the Video 1 ~ Video 4 and set the video setup.
⚙️ Click 'Apply' to set the other video setting.
- 2 **Date / Time** - Display the current time.
- 3 **User Text** - Output the TEXT entered by the user. Support a maximum of 30 characters.
- 4 Click 'Apply' to make above setting effective.

Setup - Video & Audio Setup

Region of Interest Configuration

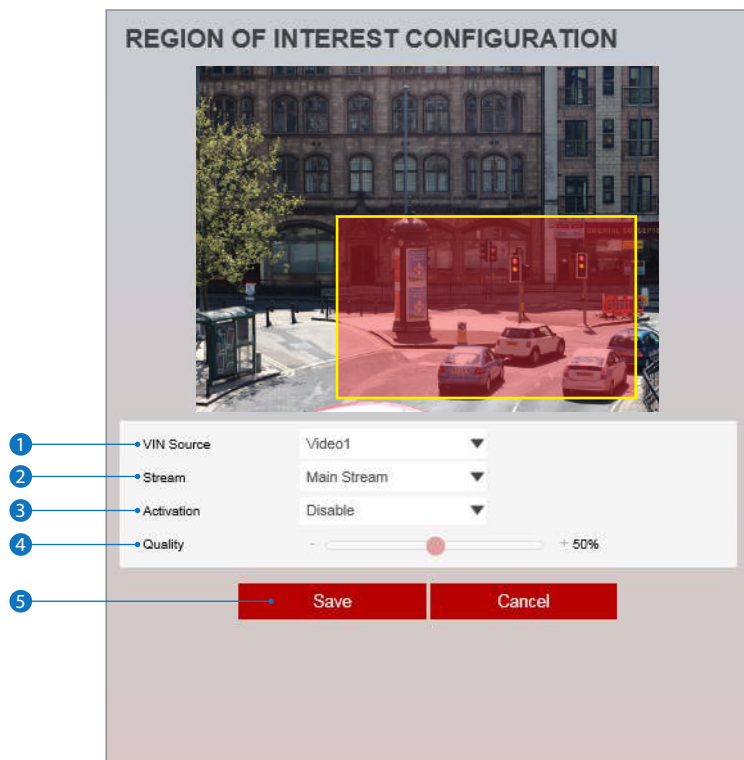

Region of interest function gives much more efficiency picture quality for indicated area to improve picture qualities of movement scene at the same bandwidth.

1 **VIN Source** - Select the Video 1 ~ Video 4 and set the video setup.
⚠ Click 'Save' to set the other video setting.

2 **Stream** - Select the Stream.
⚠ Currently it supports only H.264, H.265 (HEVC).
⚠ The function is not supported in MJPEG codec.

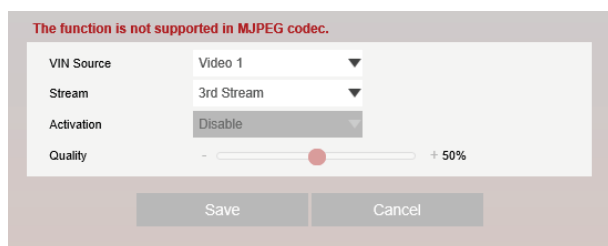

3 **Activation** - The Region of interest can be enable or disable.

4 **Quality** - Set the quality of the set area.

5 Click 'Save' to save the current settings.
⚠ Click 'Cancel' to return to the previous setting.

Setup - Video & Audio Setup

Audio Configuration

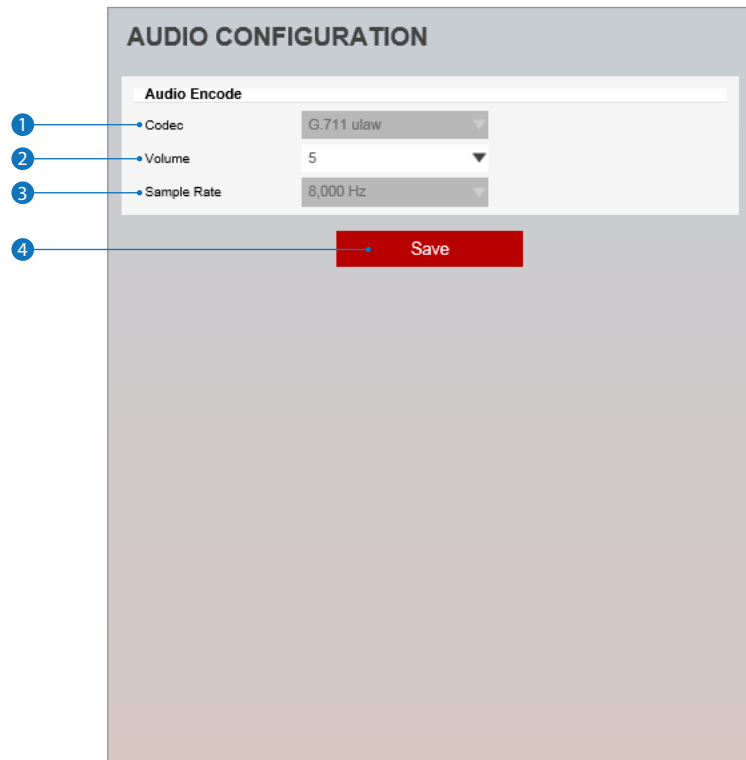

- 1 **Codec** - Select the Audio Codec.
☒ Currently it supports only codec G.711.
- 2 **Volume** - Select the Audio Volume from 0 to 10.
- 3 **Sample Rate** - Select the Audio Sample Rate.
☒ Currently it supports only 8000 Hz.
- 4 Click 'Save' to make above setting effective.

Setup - Video & Audio Setup

Privacy Mask Configuration

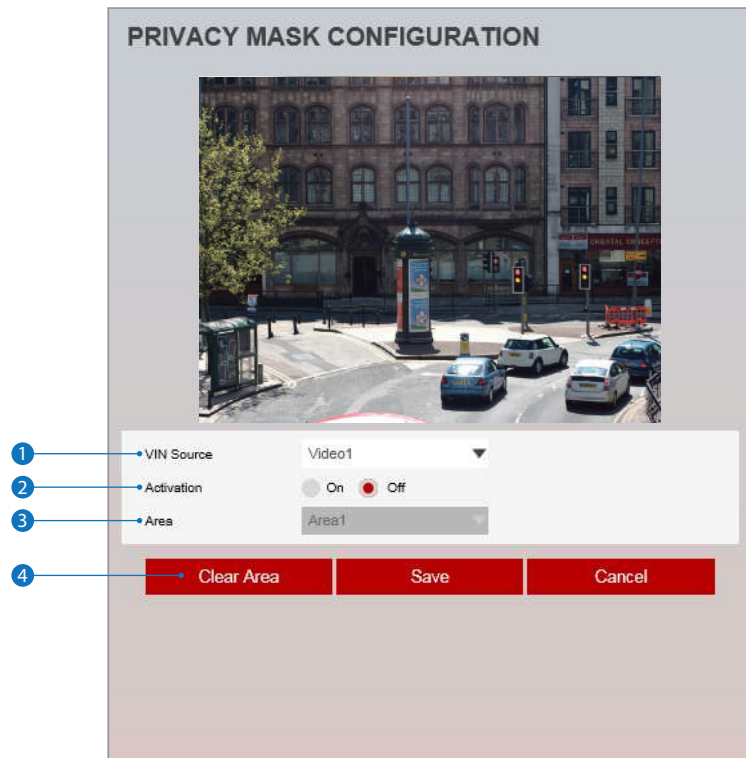

Use this function to mask areas that you want to hide on screen to protect privacy.

- 1 **VIN Source** - Select the Video 1 ~ Video 4 and set the video setup.
 - ☒ Click 'Save' to set the other video setting.
- 2 **Activation** - The Privacy mask function can be enable or disable.
- 3 **Area** - Select the Area1 ~ Area16 and Set the privacy area.
- 4 Click 'Save' to save the current settings.
 - ☒ Click 'Cancel' to return to the previous setting.
 - ☒ Click 'Clear Area' to delete the selected Area1~Area16.

Setup - Camera Setup

MFZ Configuration



- 1 Zoom & Focus** - You can zoom OUT (-) or zoom IN (+) and focus OUT (-) or focus IN (+).
☒ Focus button (-) / (+) is activated in Manual mode.
- 2 Zoom Speed** - Set the speed of zoom and focus. (1~3)
- 3 Auto & Manual** - Click the button to switch focus mode (Auto / Manual).
Auto mode - Auto focus is activated after zoom button (-) / (+) action. After auto button action, auto focus is activated once and focus button (-) / (+) is deactivation.
Manual mode - You can manually adjust the focus position. Focus button (-) / (+) is activated.

Setup - Camera Setup

Profile Configuration

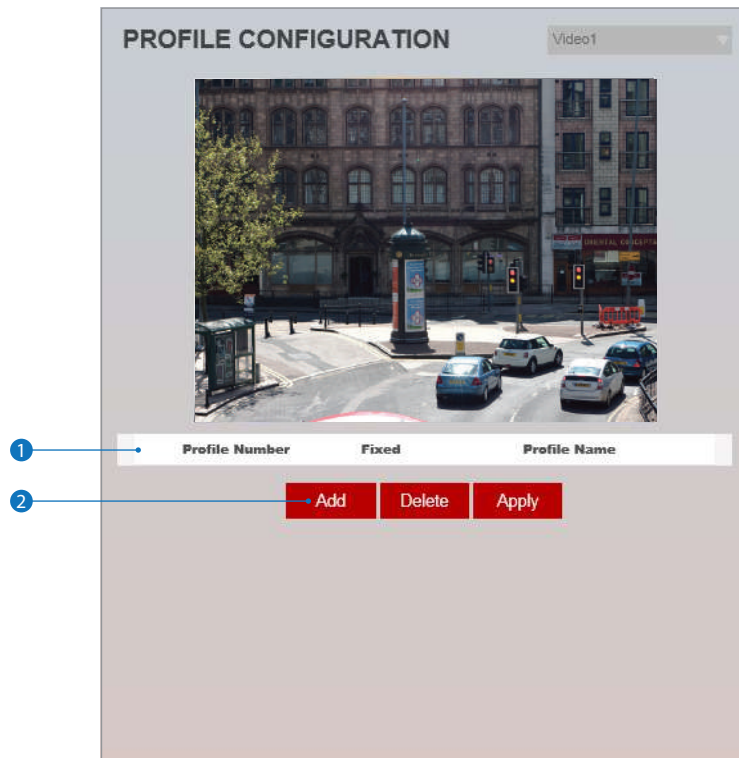

- 1 **Profile List** - Display the information in profile list.
- 2 Click 'Add' to add the profile stored the current camera settings.
 - ☒ Click 'Delete' to delete selected item from the profile list.
 - ☒ Click 'Apply' to apply selected item from the profile list.

Setup - Camera Setup

Camera Image Adjustment

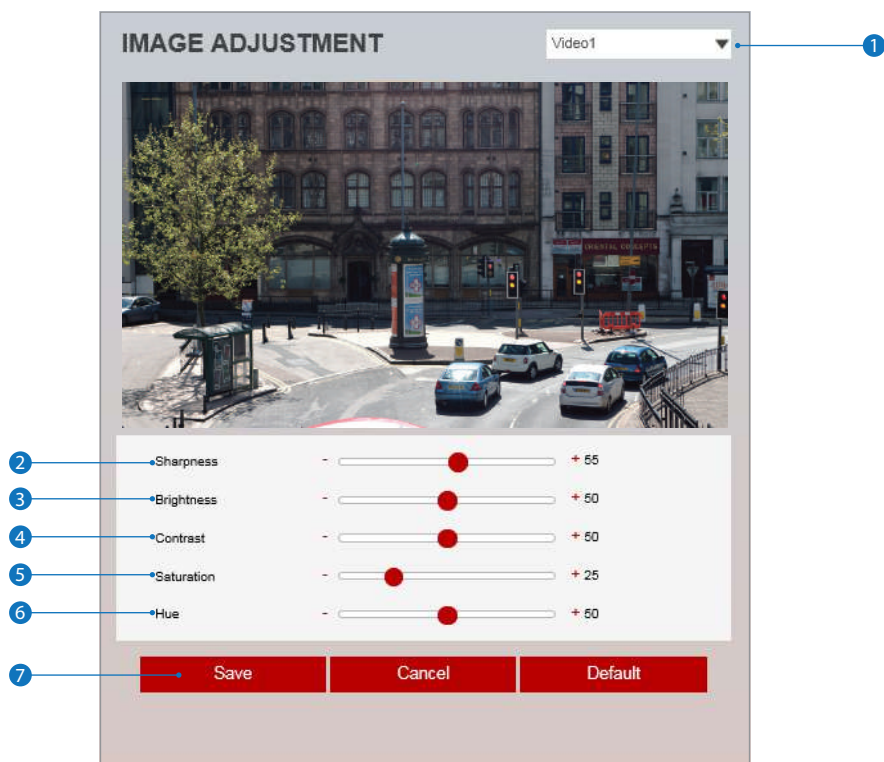

- 1 **VIN Source** - Select the Video 1 ~ Video 4 and set the video setup.
 - ☒ Click 'Save' to set the other video setting.
- 2 **Sharpness** - Using this control, sharpness of image can be adjusted to meet your preference.
- 3 **Brightness** - Using this control, brightness of image can be adjusted to meet your preference.
- 4 **Contrast** - Using this control, contrast of image can be adjusted to meet your preference.
- 5 **Saturation** - Using this control, Saturation of image can be adjusted to meet your preference.
- 6 **Hue** - Using this control, Hue of image can be adjusted to meet your preference.
- 7 Click 'Save' to save the current settings.
 - ☒ Click 'Cancel' to return to the previous setting.
 - ☒ Click 'Default' to settings to the factory defaults.

Setup - Camera Setup

Camera Exposure Settings

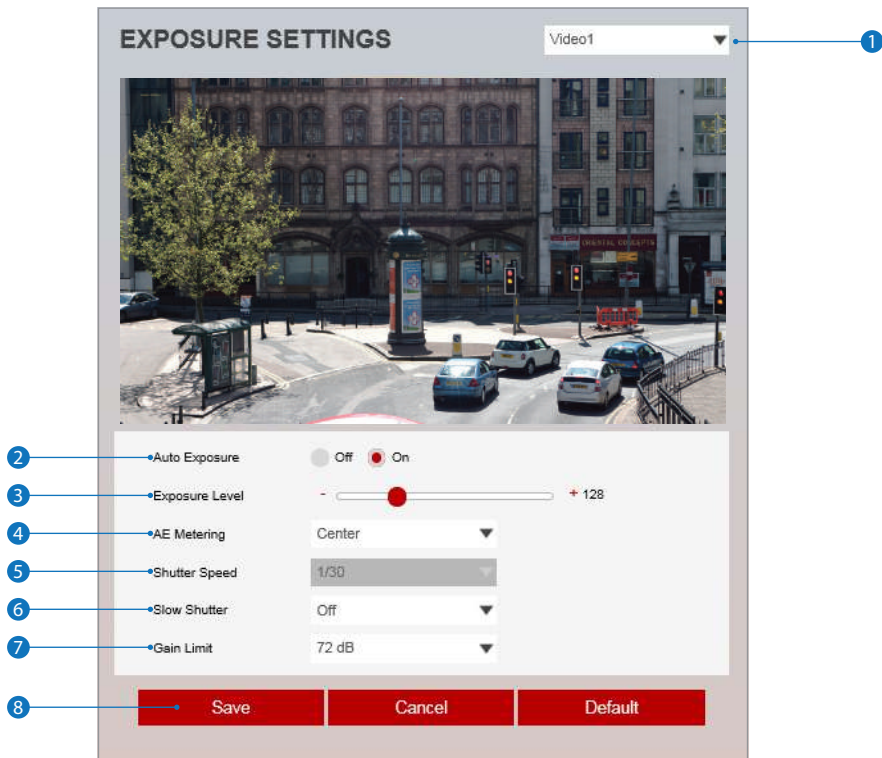

- 1 **VIN Source** - Select the Video 1 ~ Video 4 and set the video setup.
 - ⊠ Click 'Save' to set the other video setting.
- 2 **Auto Exposure** - Automatic exposure(AE) automatically sets the aperture or shutter speed, based on the external lighting conditions for the photo.
- 3 **Exposure Level** - If this value is increases, the image becomes brighter.
- 4 **AE metering** - AE metering mode refers to the way in which a camera determines the exposure.
- 5 **Shutter Speed** - If this speed is faster, the moving object can be photographed without the ghost effect. However, picture can be dark if there is no sufficient lighting.
- 6 **Slow Shutter Level** - Slow shutter Level lets you adjust the amount of light striking the sensor, and essentially determines when the video sensor sends out its batch of data for processing.
- 7 **Gain Limit** - The smaller number makes the darker image.
- 8 Click 'Save' to save the current settings.
 - ⊠ Click 'Cancel' to return to the previous setting.
 - ⊠ Click 'Default' to settings to the factory defaults.

Setup - Camera Setup

Camera Day & Night Settings

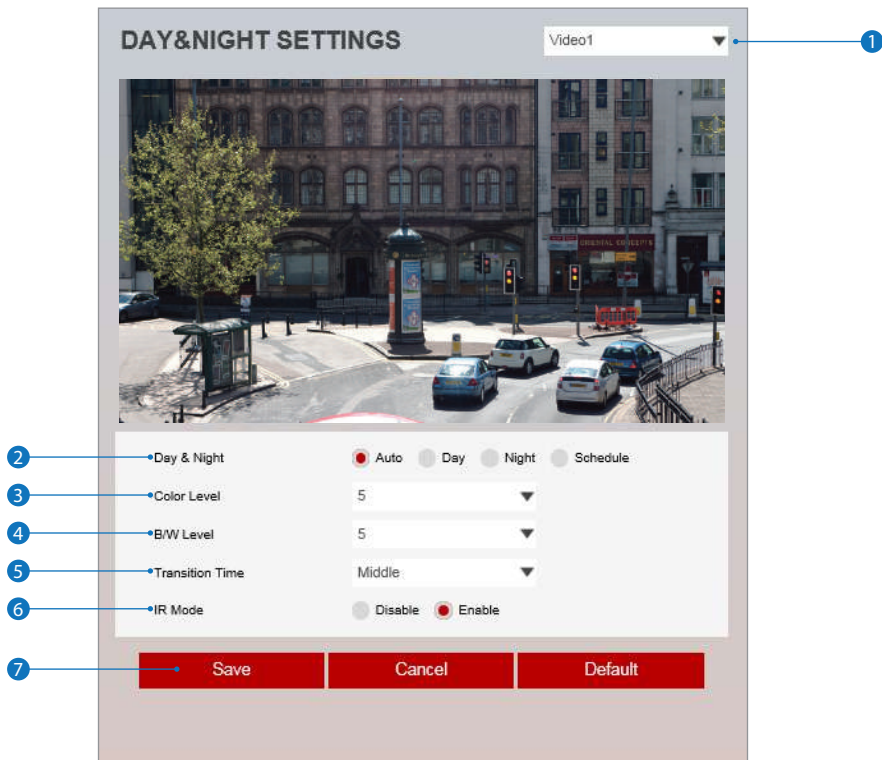

1 **VIN Source** - Select the Video 1 ~ Video 4 and set the video setup.

☒ Click 'Save' to set the other video setting.

2 **Day & Night**

- **Auto:** In this mode, the IR cut filter is removed automatically depending on the light condition around.

- **Day:** In this mode, the IR cut filter is applied to the image sensor all the time.

Thus, the sensitivity will be reduced in the dark light condition but the better color reproduction performance are obtained.

- **Night:** In this mode, the IR cut filter on the image sensor is removed all the time.

The sensitivity will be enhanced in the dark light condition but the image is black and white.

- **Schedule:** In this mode, Day / Night mode is converted accordance with the scheduled time.

3 **Color Level** - It is a level to change Night mode into Day mode when Day & Night mode is Auto.

4 **B / W Level** - It is a level to change Day mode into Night mode when Day & Night mode is Auto.

5 **Transition Time** - If it is set to Auto, to determine the rate at which Day / Night is converted.

6 **IR Mode** - The IR function can be enable or disable.

7 Click 'Save' to save the current settings.

☒ Click 'Cancel' to return to the previous setting.

☒ Click 'Default' to settings to the factory defaults.

Setup - Camera Setup

Camera Backlight Settings

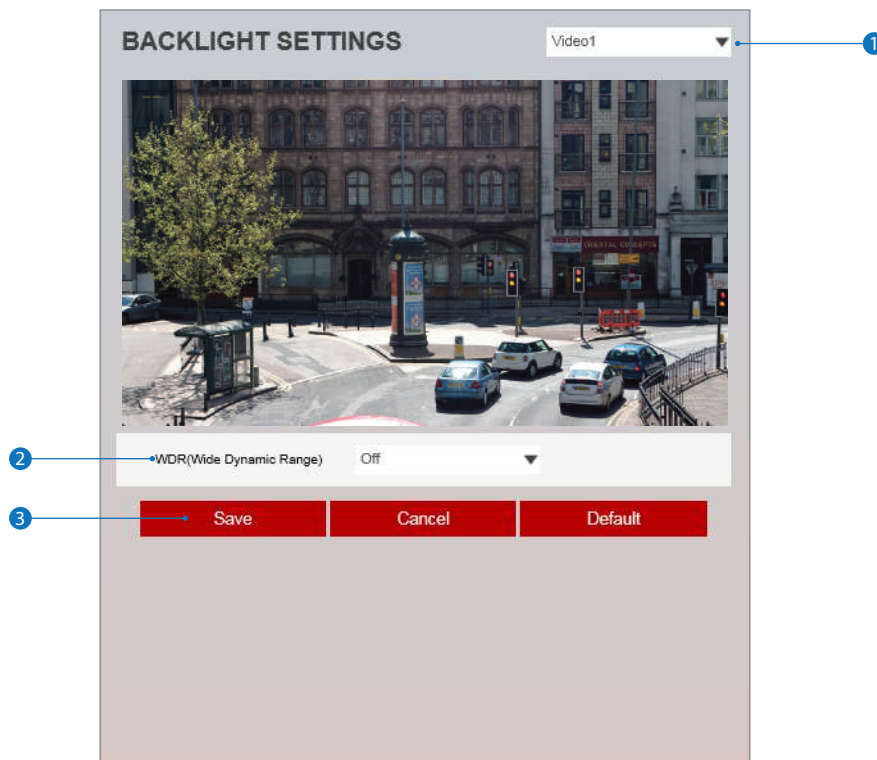

This is a feature used for problematic light conditions where the contrast from light to dark areas is very high.

- 1 **VIN Source** - Select the Video 1 ~ Video 4 and set the video setup.
 - ☒ Click 'Save' to set the other video setting.
- 2 **WDR (Wide Dynamic Range)** - The WDR function can be enable or disable.
- 3 Click 'Save' to save the current settings.
 - ☒ Click 'Cancel' to return to the previous setting.
 - ☒ Click 'Default' to settings to the factory defaults.

Setup - Camera Setup

Camera White Balance

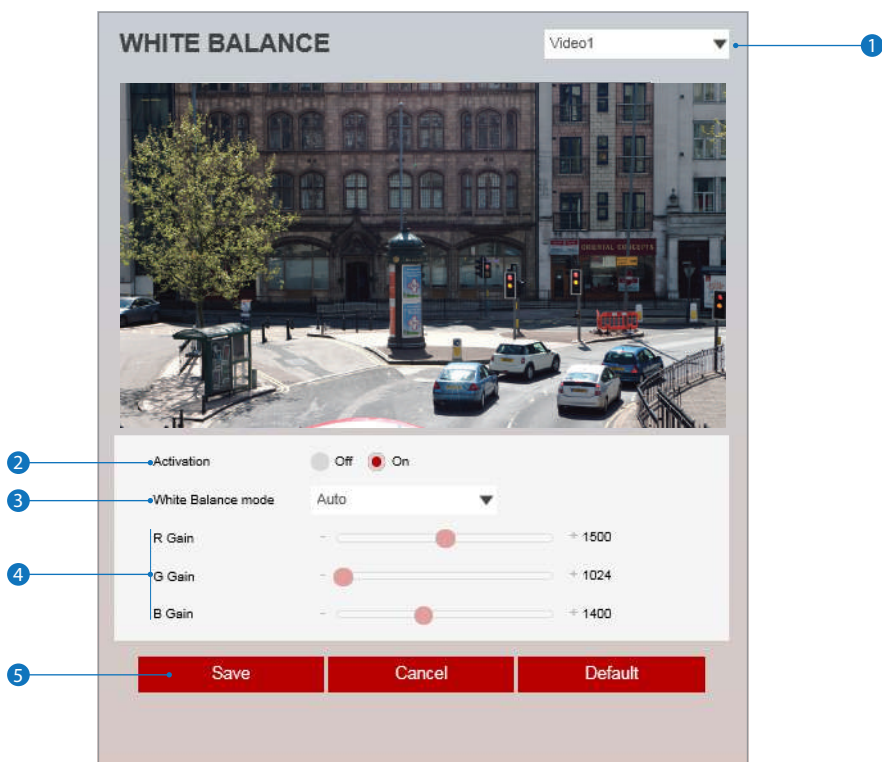

- 1 **VIN Source** - Select the Video 1 ~ Video 4 and set the video setup.
 - ☒ Click 'Save' to set the other video setting.
- 2 **Activation** - White Balance can be enable or disable.
- 3 **White Balance Mode** - Select White Balance depending on the lighting conditions.
- 4 **RGB Gain** - The R/G/B gain can be set only when the White Balance Mode is set to Manual.
- 5 Click 'Save' to save the current settings.
 - ☒ Click 'Cancel' to return to the previous setting.
 - ☒ Click 'Default' to settings to the factory defaults.

Setup - Camera Setup

Camera Image Enhancement

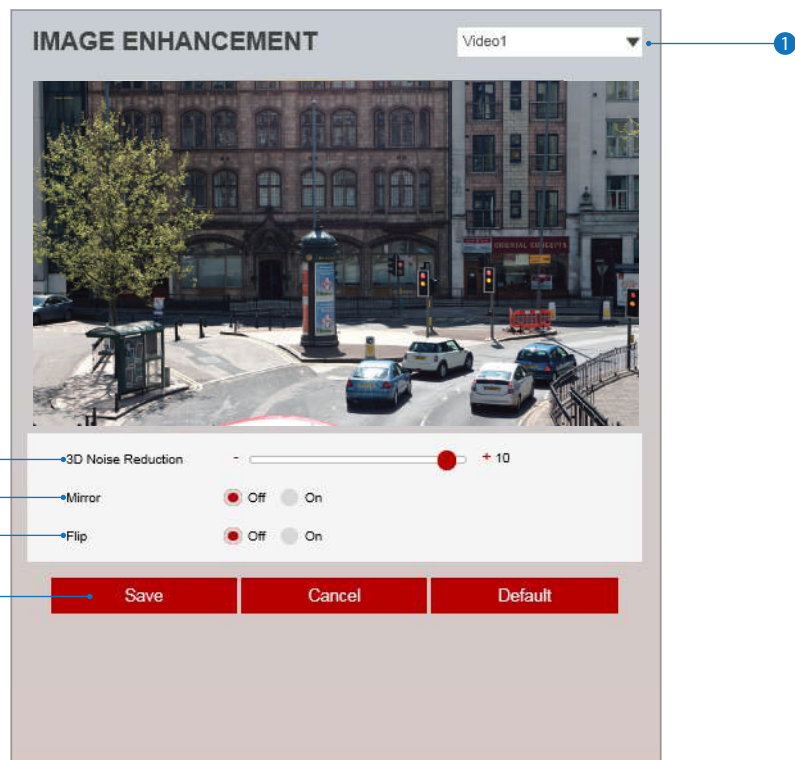

- 1 **VIN Source** - Select the Video 1 ~ Video 4 and set the video setup.
 - ☒ Click 'Save' to set the other video setting.
- 2 **3D Noise Reduction** - 3DNR function enables to suppress noise and retain good video quality in low light conditions.
- 3 **Mirror** - Reverse the video from side to side.
- 4 **Flip** - Reverse the video from up to down.
- 5 Click 'Save' to save the current settings.
 - ☒ Click 'Cancel' to return to the previous setting.
 - ☒ Click 'Default' to settings to the factory defaults.

Setup - Camera Setup

Video Enhancement

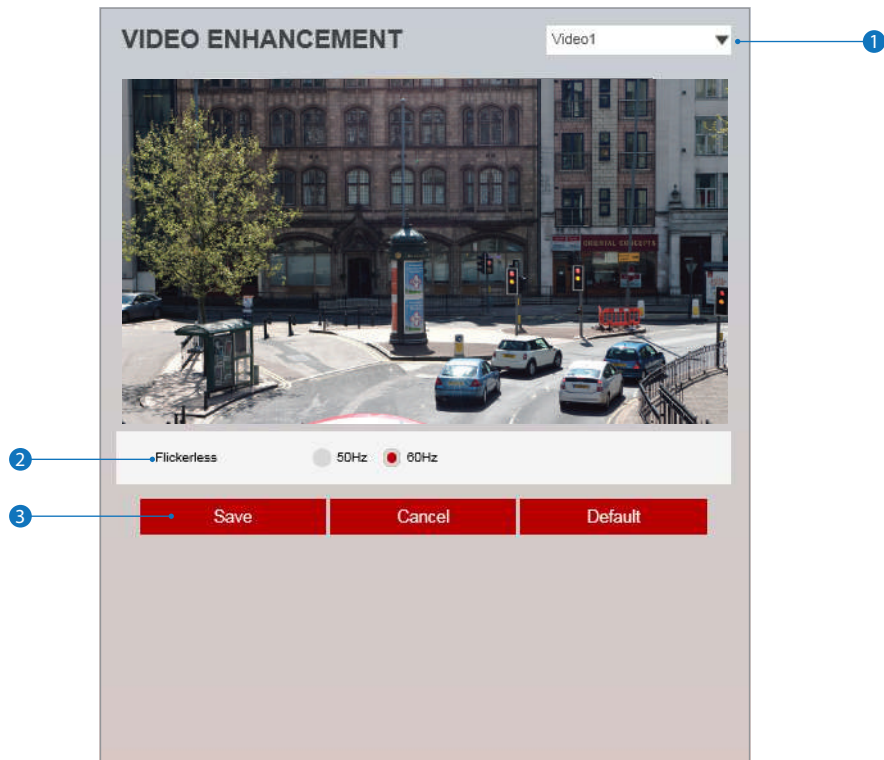

- 1 **VIN Source** - Select the Video 1 ~ Video 4 and set the video setup.
 - ☒ Click 'Save' to set the other video setting.
- 2 **Flicker** - This function Enable to enhance the flicker situation.
- 3 Click 'Save' to save the current settings.
 - ☒ Click 'Cancel' to return to the previous setting.
 - ☒ Click 'Default' to settings to the factory defaults.

Setup - Network Setup

Network Status

NETWORK STATUS	
MAC Address	00:0D:F1:33:93:33
IP Address	192.168.1.30
Subnet Mask	255.255.0.0
Default Gateway	192.168.1.1
Preferred DNS Server	210.220.183.82
Alternate DNS Server	219.250.36.130
HTTP Port	80
HTTPS Port	443
RTSP Port	554

This menu will show you all the information of Network setting in the camera. However, you cannot change those here.

Setup - Network Setup

Network Settings

NETWORK SETTINGS

Host name: IPNC

1 Network Type
 Static Dynamic

IP setup

2 IP Address: 192.168.1.30
3 Subnet Mask: 255.255.0.0
4 Default Gateway: 192.168.1.1
5 Preferred DNS Server: 210.220.163.82
6 Alternate DNS Server: 219.250.36.130

Port Setup

7 HTTP Port: 80 [Default: 80, 1025 ~ 60000]
8 HTTPS Port: 443 [Default: 443, 1025 ~ 60000]
9 RTSP Port: 554 [Default: 554, 1025 ~ 60000]

10 Apply

1 Network Type - Define network IP address type from the Static Mode for the fixed IP or the Dynamic Mode by the dynamic IP address.

If you select the Static Mode, you must fill out IP Address, Subnet Mask, Gateway, DNS Server and all ports.

If you select the Dynamic Mode, the IP address will be allocated automatically by DHCP equipment.

If you click the Apply button to update changes, the system will be re-booted.

In this case, you have to reconnect the camera using new IP address.

2 IP Address - Define the IP address. The address is consisted of four numbers separated by dots and the range of each number is from 0 to 255.

3 Subnet Mask - Define the Subnet Mask. Format is same as the IP address.

4 Default Gateway - Default the Gateway IP Address. Format is same as the IP address.

5 Preferred DNS Server - Define the DNS server IP address. Format is same as the IP address.

6 Alternate DNS Server - Define the Secondary DNS server IP address. Format is same as the IP address.

7 HTTP Port - The HTTP port can be set to 80 which default or in between 1025 to 60000.

8 HTTPS Port - The HTTPS port can be set to 443 which default or in between 1025 to 60000.

9 RTSP Port - The RTSP port can be set to 554 which default or in between 1025 to 60000.

10 Click 'Apply' to make above setting effective.

⚠ If the network type is dynamic, the IP address is changed in below cases.

Therefore, the IP address needs to be searched again, and the camera needs to be reconnected in these cases.

- When the camera power is on / off.

- After Firmware update, Default set and reboot.

Setup - Network Setup

Auto IP Settings

AUTO IP SETTINGS	
General Setting	
<input type="radio"/> Off <input checked="" type="radio"/> On	
UNIQUE ID	df1eef9a-8836-40d8-9fab-4ffa00f508ef
AUTO IP ADDRESS	169.254.145.255
<input type="button" value="Apply"/>	

- 1 **General Setting** - Auto IP Settings function can be enable or disable.
- 2 **Auto IP Settings Information** - It displays the unique id or Auto IP address.
- 3 Click 'Apply' to make above setting effective.

Setup - Network Setup

ONVIF Settings

The screenshot shows the 'ONVIF SETTINGS' configuration page. It features two main sections: 'Authentication' and 'Discovery mode'. The 'Authentication' section has three radio button options: 'None', 'WS-Usertoken', and 'WS-Usertoken + Digest', with the third option selected. The 'Discovery mode' section has two radio button options: 'Discoverable' and 'Nondiscoverable', with the first option selected. A red 'Apply' button is located at the bottom of the settings area. Three blue callout boxes with numbers 1, 2, and 3 point to the 'Authentication' section, the 'Discovery mode' section, and the 'Apply' button, respectively.

1 Authentication

None: Allows to access without ONVIF authentication.

WS - Usertoken: Allows to access with WS-User Token of ONVIF authentication.

WS - Usertoken + Digest: Allows to access with WS-User Token and Digest of ONVIF authentication.

2 Discovery Mode - The discovery function can be enable or disable.

3 Click 'Apply' to make above setting effective.

Setup - Network Setup

UPNP Settings

UPNP SETTINGS

1 • General Setting
 Off On

2 • Device Information
FriendlyName IP Camera

3 Apply

- 1 **General Setting** - UPNP function can be enable or disable.
- 2 **Friendly Name** - Define the friendly name. Support a maximum of 30 characters and special character (/ ~ ! \$ ^ () { } [] ; ,) can not be used. (' @ ' , ' _ ' - ' ') can be used.
- 3 Click 'Apply' to make above setting effective.

Setup - Network Setup

DDNS Settings

DDNS SETTINGS

Disable

Public DDNS

Address:

Host Name:

User Name:

Password:

- 1 DDNS Disable** - If it is selected, DDNS service does not work.
- 2 Public DDNS** - To use public DDNS service, select a site address listed in the list. After filling out the Host Name of the site, the setup is completed by entering User Name and Password registered in that DDNS site.

DDNS Provider	Site Address
DynDNS	www.dyndns.com
No-IP	www.no-ip.com

- ⚠ If you setup DDNS properly, the IP address of your camera will be updated automatically whenever IP address is changed or system is rebooted.
 - ⚠ If IP updating to DDNS site is failed, camera will keep retrying in 1min. interval.
- 3** Click 'Apply' to make above setting effective.

Setup - Network Setup

FTP Settings

FTP SETTINGS

General Setting

Off On

Server information

FTP Server Address

FTP Upload Path /

FTP Port 21

User ID

Password

Apply

To transfer / save the image to the relevant sites through FTP, then FTP needs to be setup.

- 1 **General Setting** - FTP function can be enable or disable.
- 2 **FTP Server Address** - Define FTP Server IP Address. If IP Address form is incorrect, a Message box will be shown to try again.
- 3 **FTP Upload Path** - Define a path in FTP server to store video. For the path name, English Alphabets, numbers and special characters (/ ~ ! @ \$ ^ () _ - { } [] ; ,) can be used.
- 4 **FTP Port** - Define the FTP Server Port. If Port is not appropriate, it is impossible to access to FTP Server.
- 5 **User ID** - Define User ID to access to the FTP Server. Fill out the correct User ID registered in the FTP Server.
- 6 **Password** - Define Password to access to the FTP Server. Fill out the correct Password registered in the FTP Server.
- 7 Click 'Apply' to make above setting effective.
☒ Refer the above screen image for the example.

Setup - Network Setup

SMTP Settings

The screenshot shows the 'SMTP SETTINGS' configuration page. It is divided into three main sections: 'General Setting', 'Account information', and 'Mail Contents'.
1. 'General Setting' has a radio button for 'Off' (selected) and 'On'.
2. 'Account information' includes:
- 'Mode' with radio buttons for 'PLAIN' (selected) and 'SSL/TLS'.
- 'SMTP Server Address' text input field.
- 'PORT' text input field with '25' entered.
- 'User ID' text input field.
- 'Password' text input field.
- 'E-Mail Sender' text input field.
- 'E-mail Receiver' text input field.
3. 'Mail Contents' includes:
- 'Title' text input field.
- 'Message' text area with up/down arrows.
At the bottom, there is a red 'Apply' button.

To send / save the image to the relevant sites by Email, SMTP needs to be setup.

- 1 **General Setting** - SMTP function can be enable or disable.
- 2 **Mode** - Select Security mode of SMTP from Plain or SSL / TLS. After checking account setup of your SMTP Server, you may select one.
- 3 **SMTP Server Address** - Define the SMTP Server Address. If the IP Address form is incorrect, a Message box will be shown to try again.
- 4 **Port** - Define the Port used in the Plain or SSL / TLS security mode in the above.
- 5 **User ID** - Define the User ID to access to SMTP Server. Fill out the correct User ID registered in the SMTP Server.
- 6 **Password** - Define the Password to access to SMTP Server. Fill out the correct Password registered in the SMTP Server.
- 7 **E-Mail Sender** - Define the e-mail address of E-Mail Sender. It will be displayed as the sender when the camera sends an E-mail.
- 8 **E-Mail Receiver** - Define the e-mail address of E-Mail Receiver. It will be displayed as the Receiver when the camera sends an E-mail.
- 9 **Title** - Define the title of the E-Mail when the camera sends an E-mail.
⚠ The title of the Email is limited to 40 characters including the spaces.
- 10 **Message** - Define the contents of E-Mail when camera sends an E-mail. The message of the Email is limited to 40 characters including the spaces.
- 11 Click 'Apply' to make above setting effective.

Setup - Network Setup

SNMP Settings

SNMP SETTINGS

SNMP v1/v2c

SNMPv1 Off On

SNMPv2c Off On

Read community public

Write community private

SnmpTrap Off On

TrapAddress 0.0.0.0

TrapCommunity public

SNMP v3

Mode Read

Activation Off On

Read name root

Security Level no auth, no priv

Authentication Algorithm MD5

Authentication Password

Apply

1 **SNMPv1/SNMPv2** - Select the SNMPv1/SNMPv2 option and type the names of Read community and Write community.

SNMP trap can be used to check periodically for operational thresholds or failures that are defined in the MIB.

2 **SNMP Trap** - SNMP trap can be enable or disable.

SNMPv3 contains cryptographic security, a higher security level, which allows you to set the Authentication password and the Encryption password.

3 **Mode** - Select the either Read or Read/Write mode.

4 **Activation** - It can be enable or disable selected mode.

5 **Read/Write name** - Define Read name and Write name.

6 **Security Level** - Select one of no auth, no priv/auth , no priv/auth, priv

7 **Authentication Algorithm** - Select MD5 or SHA as the authentication method.

8 **Authentication Password** - The Authentication Password is an encryption for authentication and they are at least 8 digits and up to 30 digits allowed.

9 Click 'Apply' to make above setting effective.

Setup - Network Setup

RTSP Information

The screenshot shows the 'RTSP INFORMATION' configuration page. It includes sections for 'RTSP Global Setting', 'Session Timeout', 'QoS Setting', and 'Rtp Multicast'. A table at the bottom displays RTSP connection information.

No	Remote IP	Port	Type
1	127.0.0.1	45738	TCP
2	127.0.0.1	45714	TCP
3	127.0.0.1	45712	TCP
4	127.0.0.1	45716	TCP

- 1 VIN Source** - Select the Video 1 ~ Video 4 and set the video setup.
 - ☒ Click 'Apply' to set the other video setting.
- 2 Target Stream** - Select the stream you want to set.
- 3 Time out** - Set the RTSP time out.
 - ☒ The session is disconnected after the specified time out.
- 4 QoS Setting** - Set the quality of service to ensure data transfer performance.
- 5 RTP Multicast** - Check RTP Multicast Start/Stop. To activate RTP Multicast.
 1. Click "On" button.
 2. Enter accessible RTP Multicast IP, port for video stream control, RTP packet TTL.
 3. Click "Apply" button.
 - ☒ It is possible to set each RTP Multicast for CH1~3.
- 6** Click 'Apply' to make above setting effective.
 - ☒ Click this button when completed setup each channels.
- 7** It shows RTSP Connection information.

Setup - Trigger Action Setup

Action Rules Configuration

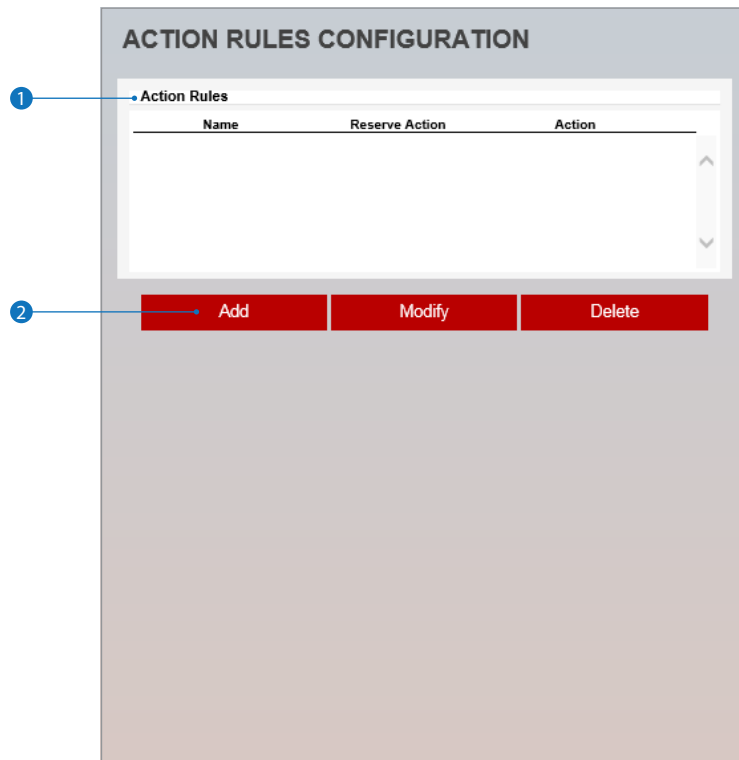

- 1 **Action rules List** - It indicates the custom action rule information added to Action rules list.
- 2 Click 'Add' to add custom action rules.
 - ☒ Click 'Modify' to modify selected item from the action rules list.
 - ☒ Click 'Delete' to delete selected item from the action rules list.

Setup - Trigger Action Setup

Action Rules Add / Modify

ACTION RULES CONFIGURATION

General Setting

1 Name NewAction

2 Operation Interval 0 Second(s) [0 ~ 60]

3 Action1 NONE

Action2 NONE

Action3 NONE

Action4 NONE

Action5 NONE

4 Save Cancel

- 1 **Name** - Define name of action rules.
 - ⊠ Input text cannot be exceed limited (3~15).
- 2 **Operation Interval** - Select the interval to maintain action.
- 3 **Action1 ~ Action5** - Select the action to take If the event occurs.
- 4 Click 'Save' to save the current settings.
 - ⊠ Click 'Cancel' to return to the previous menu.

Setup - Trigger Action Setup

Image Transfer Configuration

IMAGE TRANSFER CONFIGURATION

1. Add the FTP/SMTP action in the event rules menu.
2. When an event occurs, the images will be sent to ftp/smtp address .
3. Determine the image transfer speed and the duration of image transfer after/before an event.

1 → Pre/Post Alarm Image

Number Of Image	2	Image Per Seconds(s) [1 ~ 5]
Pre-Alarm Duration	3	Second(s) [1 ~ 5]
Post-Alarm Duration	3	Second(s) [1 ~ 30]

2 → Apply

- 1 **Pre / Post Alarm Image** - Image Transfer due to event is configured by setting Image transfer rate and Pre / Post alarm duration.

	Descriptions
Number of Image	Define Number of image transferred per second.
Pre-alarm Duration	Define duration of image transfer before an event.
Post-alarm Duration	Define duration of image transfer after an event.

- 2 Click 'Apply' to make above setting effective.

Setup - Trigger Action Setup Relayout Configuration

The screenshot shows a configuration window titled "RELAYOUT CONFIGURATION". It contains the following elements:

- 1** Relay output: A dropdown menu showing "01".
- 2** Mode: Two radio buttons, "Monostable" (unselected) and "Bistable" (selected).
- 3** Idle state: Two radio buttons, "Closed" (unselected) and "Open" (selected).
- 4** Duration: A text input field containing "1" and a label "Second(s) [1 ~ 30]".
- 5** Apply: A red button labeled "Apply".

- 1 Relay Output** - Select the Relay output.
 - ⚠ The number of relay outputs depends on the camera model.
- 2 Mode** - Select the monostable / bistable for relay mode.
- 3 Idle State** - Select whether the contact is normally opened or is closed.
- 4 Duration** - Relay out is operated during the setting time.
 - ⚠ If monostable mode is selected, this function is activation.
- 5** Click 'Apply' to make above setting effective.

Setup - Event Setup

Event Rules Configuration

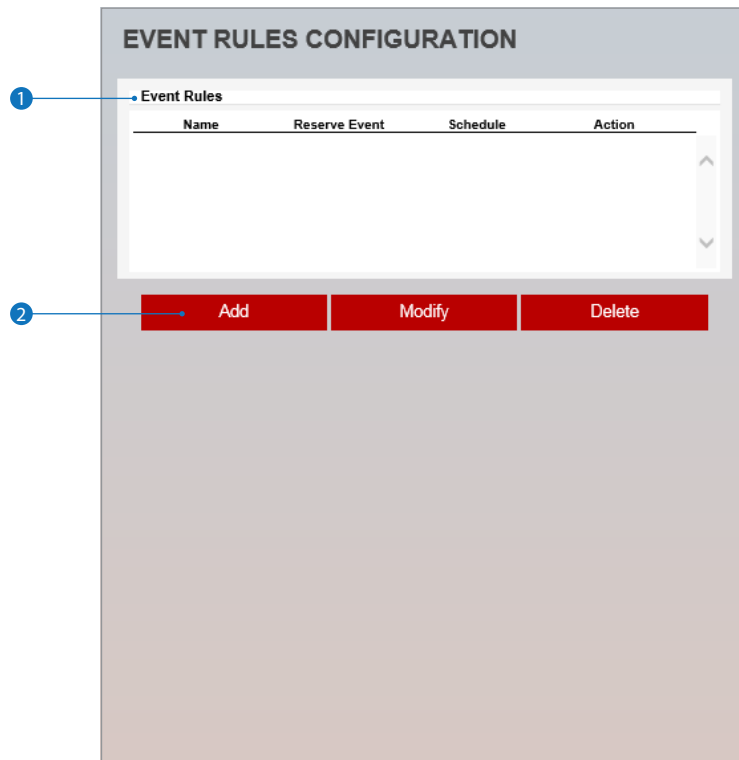

- 1 **Event Rules List** - It indicates the custom Event Rule information added to Event Rules list.
- 2 Click 'Add' to add custom event rules.
 - ⊠ Click 'Modify' to modify selected item from the event rules list.
 - ⊠ Click 'Delete' to delete selected item from the event rules list.

Setup - Event Setup

Event Rules Configuration

The screenshot shows the 'EVENT RULES CONFIGURATION' interface. It is divided into three main sections: 'General', 'Event Condition', and 'Action'.
1. **General**: Contains an 'Activation' toggle (On/Off), a 'Name' text field (containing 'NewRule'), and a 'Rules' dropdown menu (containing 'NONE').
2. **Event Condition**: Contains an 'Event' dropdown menu (containing 'NONE'), a 'Schedule' section with 'Always' and 'Manual' radio buttons, and a 'Time' section with 'Week' and 'Time' sub-sections. The 'Week' section has checkboxes for Sun, Mon, Tue, Wed, Thu, Fri, and Sat. The 'Time' section has four dropdown menus for HH:MM format (00:00 ~ 00:00).
3. **Action**: Contains a 'Rules' dropdown menu (containing 'NONE').
At the bottom, there are two red buttons: 'Save' and 'Cancel'.
Numbered callouts 1-7 point to: 1. Activation toggle, 2. Name field, 3. Event dropdown, 4. Schedule radio buttons, 5. Time dropdowns, 6. Rules dropdown, and 7. Save/Cancel buttons.

- 1 Activation** - The Event Rules function can be enable or disable.
- 2 Name** - Define the Event rule name.
- 3 Event** - Select the event among motion detection, network disconnection, illegal login detected, temperature critical, schedule, sensor detection.
 - ⊠ Click 'Cancel' to return to the previous setting.
 - ⊠ You need a event one more.
- 4 Schedule** - Select activation time from Always / Manual Time.
- 5 Week / Time** - You need to define Start time and End time followed by selecting Days. The setup schedule is repeated every week.
- 6 Rules** - Select the action rule defined in the Trigger Action-Action rule menu.
- 7** Click 'Save' to save the current settings.
 - ⊠ Click 'Cancel' to return to the previous setting.

Setup - Event Setup

Schedule Configuration

SCHEDULE CONFIGURATION

Recurrences Function

1 Mode Enable Disable

2 Repeat rule Every 5 minutes

3 Apply

- 1 **Mode** - The Schedule function can be enable or disable.
- 2 **Repeat Rule** - Set a recurring time the event occurs.
- 3 Click 'Apply' to make above setting effective.

Setup - Event Setup

Motion Detection Configuration

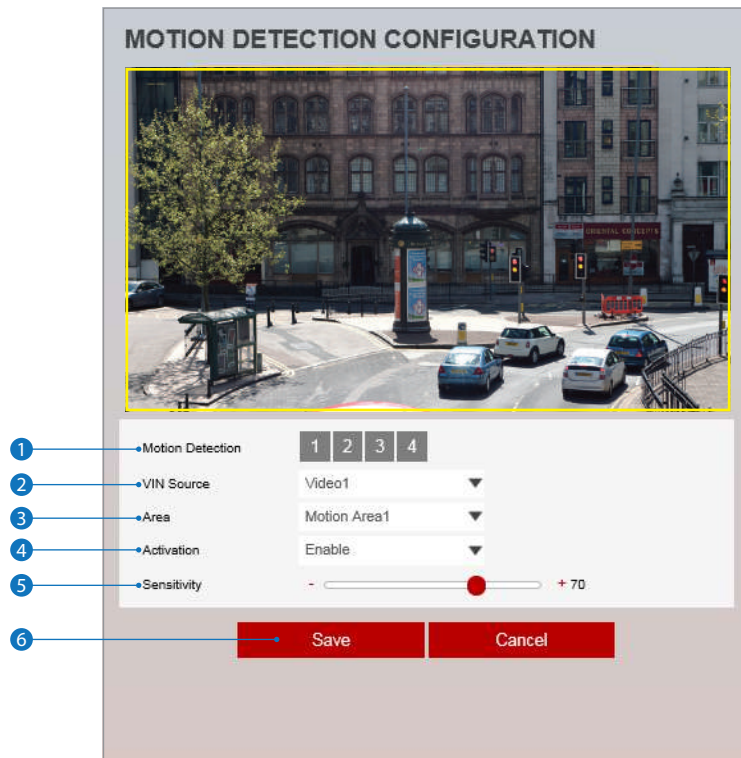

- 1 Motion Detection** - It shows the Motion event status.
 - ☒ Event Alert Icon (**1**) appears if 'Motion Detection' is activated.
- 2 VIN Source** - Select the Video 1 ~ Video 4 and set the video setup.
 - ☒ Click 'Save' to set the other video setting.
- 3 Area** - Set the motion detected area.
 - ☒ You can set up to four areas.
- 4 Activation** - Enable or Disable motion detection function.
- 5 Sensitivity** - Define the sensitivity of motion detection.
 - If High value is selected, it will detect very small motion while it becomes relatively insensitive when Low value is selected.
- 6** Click 'Save' to save the current settings.
 - ☒ Click 'Cancel' to return to the previous setting.

Setup - Event Setup

Temperature

The screenshot shows a web interface titled "TEMPERATURE" with a "General Setting" section. It contains three input fields: "Mode" (a dropdown menu set to "Fahrenheit"), "Threshold" (a text input with "150" and a range "[122 ~ 212]"), and "TEMPERATURE" (a text input with "154 °F"). A red "Apply" button is located below these fields. Four numbered callouts (1-4) point to the Mode dropdown, the Threshold input, the current temperature value, and the Apply button, respectively.

- 1 **Mode** - Select the either Fahrenheit and Celsius.
- 2 **Threshold** - Define the temperature at which the event trigger is occurred.
- 3 **Temperature** - It indicates the current temperature of the IP camera.
- 4 Click 'Apply' to make above setting effective.

Setup - Event Setup

Alarm Configuration

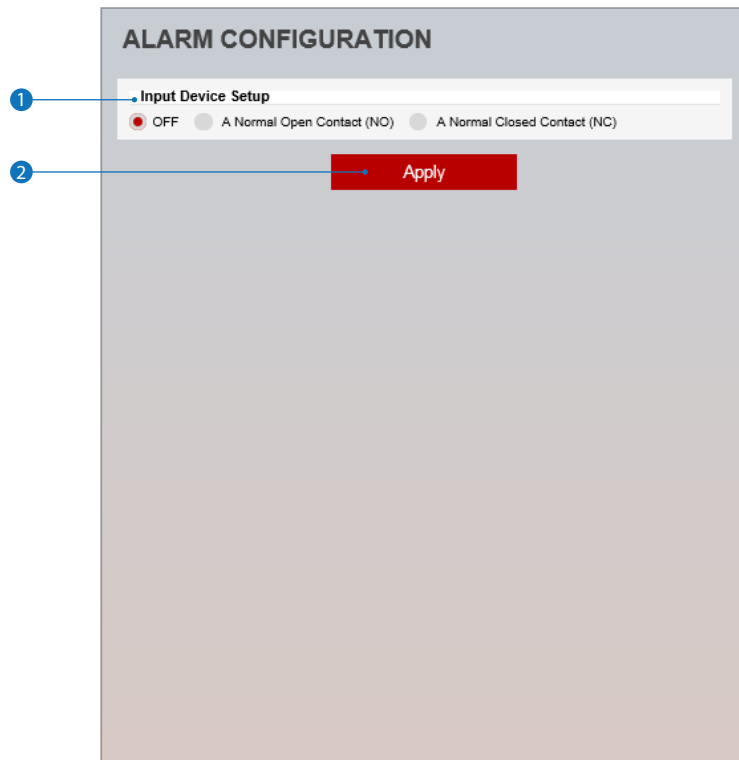

- 1 **Input Device Setup** - Select input device type from OFF / N.O. / N.C.

	Operation
OFF	Ignore this input sensor.
NO	The contact is normally open and closed when activated.
NC	The contact is normally closed and open when activated.

- 2 Click 'Apply' to make above setting effective.

Setup - Record Setup

Record Management

The screenshot shows the 'RECORD MANAGEMENT' interface. It features a 'Record Global Setting' section with a 'Target Stream' dropdown menu currently set to 'Main Stream'. Below this is a red 'Save' button. The 'RECORDING LIST' section contains a table with columns for Name, Enabled, File Type, Storage, and Continuous. A red 'Modify' button is located below the table. Four numbered callouts (1-4) point to the 'Record Global Setting' dropdown, the 'Save' button, the 'RECORDING LIST' table, and the 'Modify' button respectively.

Name	Enabled	File Type	Storage	Continuous
RECORD0	O	MP4	STORAGE1	On
RECORD1	X	MP4	STORAGE2	Off
RECORD2	X	MP4	STORAGE3	Off
RECORD3	X	MP4	STORAGE4	Off
RECORD4	X	MP4	STORAGE1	Off
RECORD5	X	MP4	STORAGE2	Off
RECORD6	X	MP4	STORAGE3	Off
RECORD7	X	MP4	STORAGE4	Off

- 1 **Target Stream** - Select the channel you want to record video.
- 2 Click 'Save' to save the current settings.
- 3 **Recording List** - Display the information about the recording settings.
- 4 Click 'Modify' to modify the selected item in the recording list.

Setup - Record Setup

Record Configuration

The screenshot shows a 'RECORD MANAGEMENT' dialog box with a 'Record Settings' section. The settings are as follows:

- 1. Enabled: Radio buttons for 'Off' (selected) and 'On'.
- 2. Storage Device: Dropdown menu showing 'SDCard 1'.
- 3. File Type: Dropdown menu showing 'MP4'.
- 4. Storage: Dropdown menu showing 'SDCard'.
- 5. Continuous: Radio buttons for 'Off' (selected) and 'On'.
- 6. Pre Duration: Input field with '5' and a range '[0 ~ 5]'.
- 7. Post Duration: Input field with '5' and a range '[1 ~ 240]'.
- 8. Save and Cancel buttons at the bottom.

- 1 **Enabled** - The Recording function can be enable or disable.
- 2 **Storage Device** - Can not be selected and shows the saved SD Card.
- 3 **File Type** - Select the recording file type.
 - ☒ Currently only supports MP4 Type.
- 4 **Storage** - Select the storage type. SD Card(Disabled) selection is not allowed.
- 5 **Continous** - If continous mode is turned on, Start the continuous recording without any other setting.
- 6 **Pre Duration** - Define duration of recording before an event.
- 7 **Post Duration** - Define duration of image transfer after an event.
- 8 Click 'Save' to save the current settings.
 - ☒ Click 'Cancel' to return to the previous setting.

Setup - Record Setup

Recording List

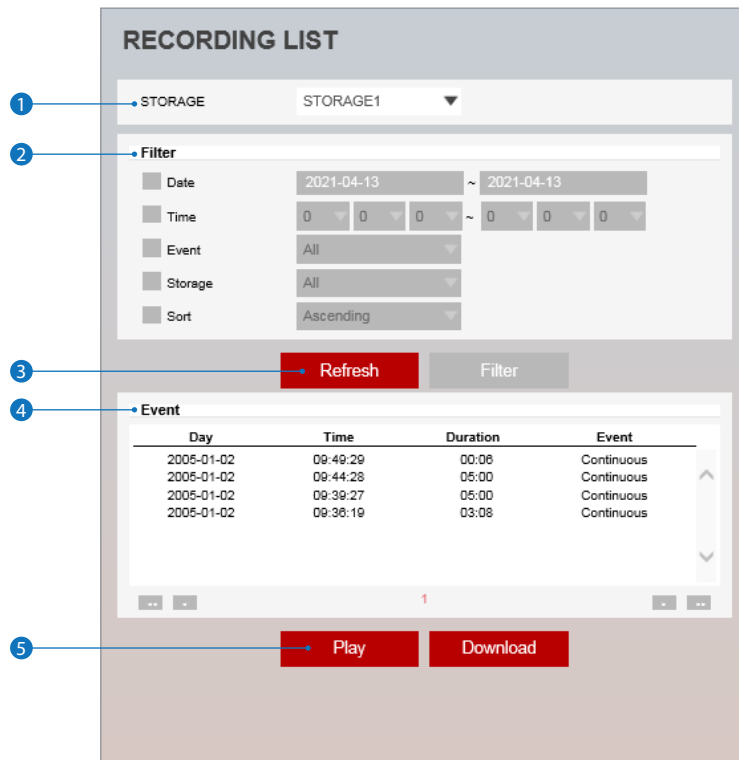

- 1 **Storage** - Select the Storage.
- 2 **Filter** - Select the date / time, event, sort or storage format to filter the recorded video.
- 3 Click the 'Refresh' button to refresh the records list.
 - ※ Click 'Filter' to view the filtered recorded video.
- 4 **Recording List** - Display the information to the recording video.
- 5 Click 'Play' to view the selected item in list of recorded video.
 - ※ Click 'Download' to download the selected item in list of recorded video.
 - When you click Download, the following window appears.
 - When downloading, please fill up the purpose within 30 characters. (The purpose you created is shown on the Log page with the download time)

Input the purpose of the file download (max : 32 characters)

- ※ When playbacking recorded MP4 file format with H.265 (HEVC) codec, video may not play due to the performance issue of VLC plug-in.

Setup - Record Setup Recording Video

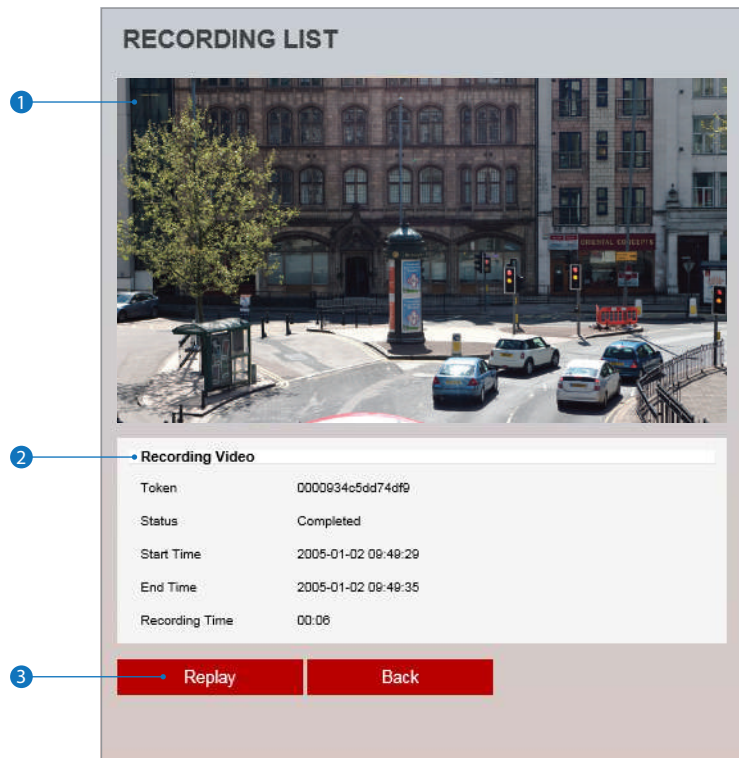

- 1 **Recording Video Viewer** - Play the recorded video.
- 2 **Recording Video Information** - Display the information about the recorded video.
- 3 Click 'Replay' to view the recorded video again.
⌘ Click 'Back' to return to the previous menu.

Setup - Record Setup

Storage Configuration

STORAGE CONFIGURATION

Notice
1. If SD Card does not automatically mount, you must format for mounting SD card.

Name	Mounted	Size	Used(%)	Available
SDCard1	<input type="radio"/>	29.7GB	1%	29.2GB
SDCard2	<input checked="" type="checkbox"/>	0	0%	0
SDCard3	<input checked="" type="checkbox"/>	0	0%	0
SDCard4	<input checked="" type="checkbox"/>	0	0%	0

Display the SD card information mounted from device.

☒ When you select the item in Storage list, You can set the functions related to the SD card.

Setup - Record Setup

Storage Configuration

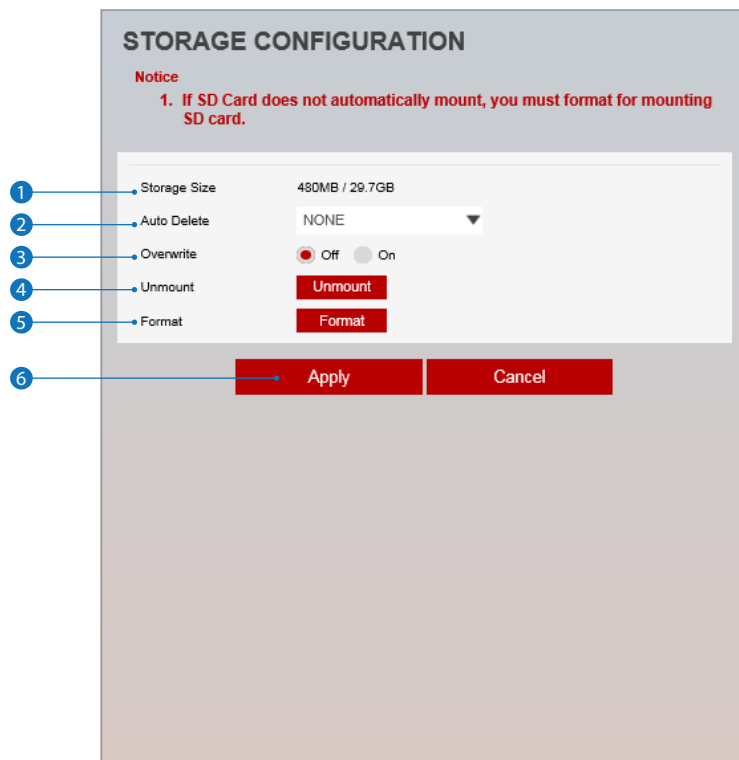

- 1 **Storage Size** - Total capacity of SD card and the remainder of it are displayed.
- 2 **Auto Delete** - Select the period for Auto delete. The image data stored before period will be deleted automatically.
 - ☒ Delete all stored image older than selected time.
- 3 **Overwrite** - If it is set ON and remained space of SD card reach to less than 8MB, new data will start to be overwritten on the oldest data. However, if it is set OFF and remained space of SD card reach to less than 8MB, image recording will be stopped.
- 4 **Unmount** - remove the SD card from the device.
- 5 **Format** - Delete the all contents that stored in SD card.
- 6 Click 'Apply' to make above setting effective.
 - ☒ Click 'Cancel' to return to the previous setting.

Setup - Security Setup

IP Address Filter Configuration

The screenshot shows the 'IP ADDRESS FILTER CONFIGURATION' interface. It is divided into two main sections: 'General Setting' and 'Filtered IP Address'.
1. In the 'General Setting' section, there is a radio button for 'IP Address Filter' with 'On' and 'Off' options. The 'Off' option is selected.
2. Below it is a dropdown menu for 'IP Filter Type' currently set to 'Allow'.
3. A red 'Apply' button is located below the dropdown.
4. The 'Filtered IP Address' section contains a large, empty text area for displaying filtered IP addresses.
5. Below the text area is an input field for 'IP Address' with a placeholder '[Invalid]'.
6. At the bottom of the input field are two red buttons: 'Add' and 'Remove'.

- 1 **IP Address Filter** - IP filter function can be enable or disable.
- 2 **IP Filter Type** - Select the recording IP filter type.
- 3 Click 'Apply' to make above setting effective.
- 4 **Filter IP Address** - Display the filtered IP address.
- 5 **IP Address** - Define the IP address you want to apply the IP filter.
- 6 Click 'Add' to add the ip address to the list.
☒ Click 'Remove' to remove the ip address selected in the list.

Setup - Security Setup

RTSP Authentication Configuration

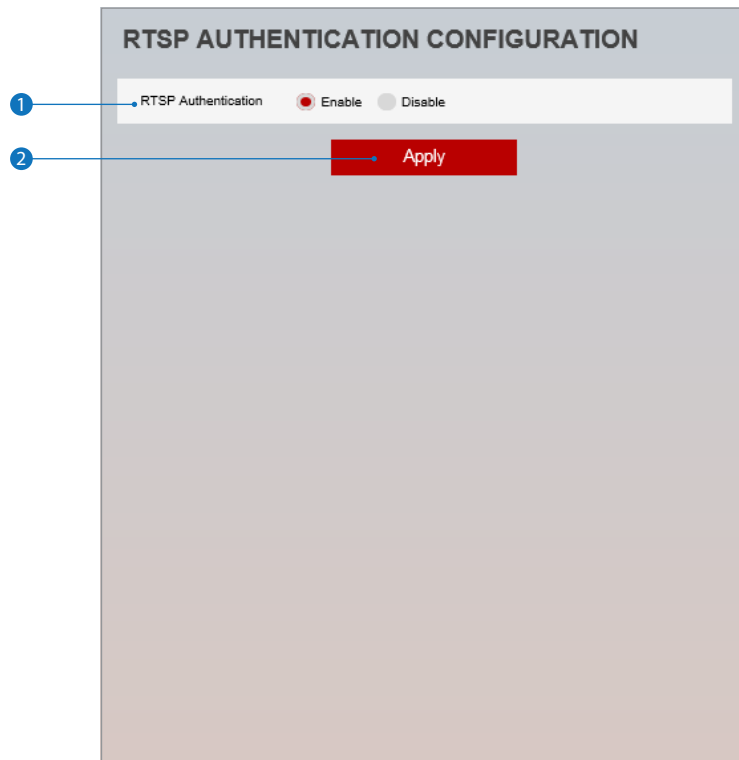

- 1 **RTSP Authentication** - RTSP Authentication can be enable or disable.
- 2 Click 'Apply' to make above setting effective.

Setup - Security Setup

IEEE 802.1X Configuration

IEEE 802.1X CONFIGURATION

General Setting

1 IEEE 802.1x On Off

2 Protocol MD5

3 EAPOL version 1

4 ID

5 Password

6 Retype Password

7 CA Certificate NONE

8 Certificate NONE

9 Apply

The feature is needed when connecting the camera to the network protected by the IEEE 802.1X.

- 1 IEEE 802.1x - The IEEE 802.1x feature can be enable or disable.
- 2 **Protocol**
 - MD5 : It provides one-way password-based network authentication of the client.
 - PEAP : It is similar to TTLS in that it does not require a certificate on the client side.
 - TTLS / MD5 : It does not require a certificate on the client side.
 - TLS : It relies on client-side and server-side certificates to perform authentication.
- 3 **EAPOL Version** - Select the EAPOL Version.
- 4 **ID** - Type the ID to identify the client in the IEEE 802.1X authentication server.
- 5 **Password** - Type the Password to identify the client in the IEEE 802.1X authentication server.
- 6 **Verify** - Verify Password.
- 7 **CA Certificate** - Select the CA certificate required for TLS, TTLS, and PEAP authentication.
- 8 **Certificate** - Select the client certificate required for TLS authentication
- 9 Click 'Apply' to make above setting effective.

Setup - Security Setup

HTTPS Configuration

HTTPS CONFIGURATION

1. If no certificates are available go to certificates to manage.

Certificates

Certificate: NONE

HTTPS connection Policy

WEB: HTTP and HTTPS

ONVIF: HTTP

RTSP OVER HTTP: HTTP

Apply

HTTPS encrypts session data over SSL or TLS protocols instead of using plain text in socket communications.

- 1 Certificate** - Select an installed certificate.
 - ⚠ If you can not select a certificate, please install the certificate from the Security->Certificates menu.
- 2 HTTPS connection Policy** - Select one of "HTTP", "HTTPS", "HTTP and HTTPS" depending on the connected web, onvif, rtsp over http.
 - WEB : "HTTP" "HTTPS" "HTTP and HTTPS"
 - ONVIF, RTSP OVER HTTP : "HTTP" "HTTPS" "HTTP and HTTPS"
- 3** Click 'Apply' to make above setting effective.
 - ⚠ When HTTPS mode is chosen, input https://<IP Address> to connect to the camera.

Setup - Security Setup

Certificates Configuration

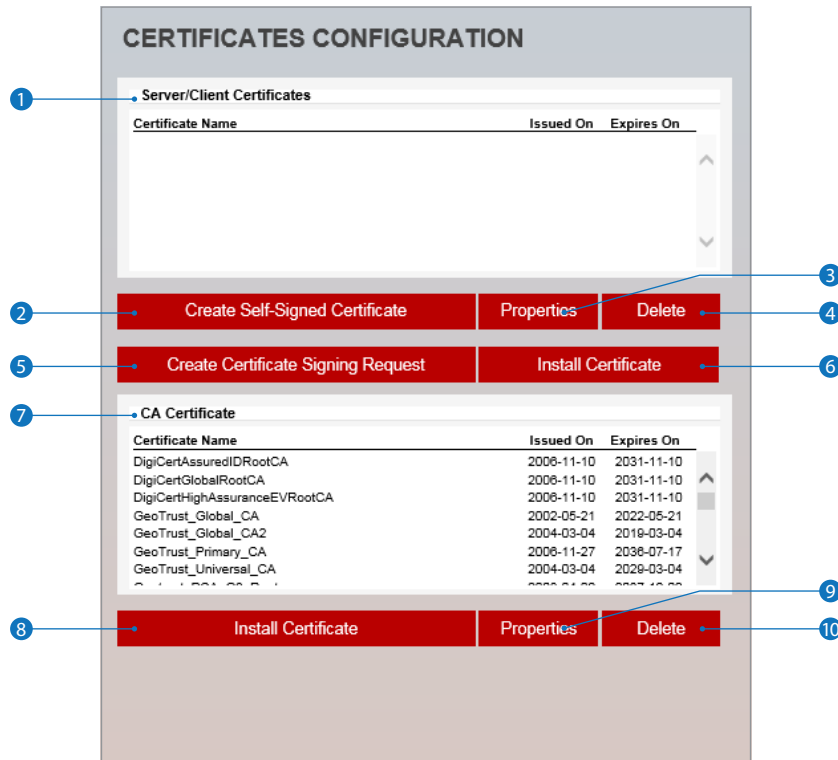

- 1 **Server/Client Certificates** - It show the installed certificates.
- 2 **Create Self-Signed Certificate** - A self-signed SSL certificate is an identity certificate signed by its own creator. But they are considered to be less trustworthy.
- 3 **Properties** - Shows information about the selected certificate.
- 4 **Delete** - Delete the selected certificate.
- 5 **Create Certificate signing request** - This is the encoded data that contains the necessary information for issuing the certificate.
⚠ They must be filled in when creating the CSR (Certificate Signing Request).
- 6 **Install Certificate** - Install Certification
- 7 **CA Certificate** - It show the installed CA certificates.
- 8 **Install CA Certificate** - Install Certification, see the detail page.
- 9 **Properties** - Shows information about the selected certificate.
- 10 **Delete** - Delete the selected CA certificate.

Setup - Security Setup

Certificates Configuration

Detail for Install Certification.

- 1 **Certificate From Signing Request** - Select to install signed certificate returned from the CA.
- 2 **Certificate And Private Key** - Select to install Certificate And Private Key to install a certificate and private key.
- 3 **Certificate Name** - Enter a unique name to identify certificate.
- 4 **Select File** - Choose certification file.
- 5 **OK** - Request installing certificate.
- 6 **Cancel** - Cancel install certificate and then back to certificates configuration.

Detail for Install CA Certification.

- 7 **Certificate Name** - Enter a unique name to identify CA certificate.
- 8 **Select File** - Choose CA certification file
- 9 **OK** - Request installing CA certificate.
- 10 **Cancel** - Cancel install CA certificate and then back to certificates configuration.

Setup - Security Setup

Service Configuration

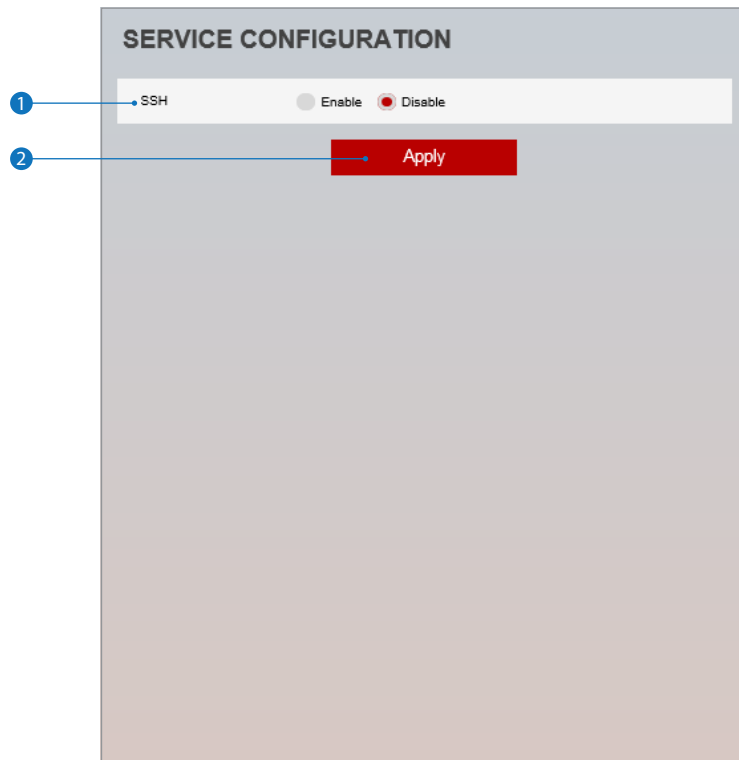

- 1 SSH - The SSH function can be enable or disable.
- 2 Click 'Apply' to make above setting effective.

Setup - System Setup

System Information

SYSTEM INFORMATION

1 Device Name IP-Camera

2 Location unknown

3 Apply

Model Name	IPM312-6211IR
Manufacturer	VCA
Max Resolution	2562x1944
Max Framerate	30 fps
Photo Resistor(CDS)	SUPPORT
Alarm In	SUPPORT
Relay out	SUPPORT
Audio	SUPPORT
Optical Zoom	X5
Digital Zoom	NOT SUPPORT
PTZ	NOT SUPPORT
Slave Version	Slave 1 2021.04.05_S13.2.1 Slave 2 2021.04.05_S13.2.1 Slave 3 2021.04.05_S13.2.1

System Capability information.

- 1 **Device Name** - You can define the device name.
- 2 **Location** - Shows camera's location.
- 3 Click 'Apply' to make above setting effective.

Setup - System Setup

System Diagnostics

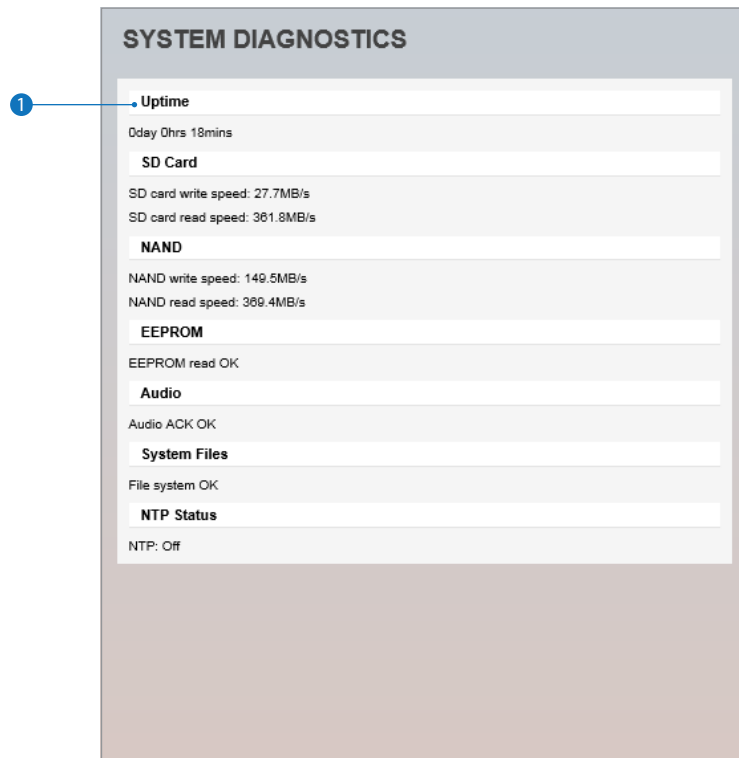

Shows basic hardware functions after inspection.

1 Shows Uptime, SD card, NAND, EEPROM, Audio chip, Important file system and NTP Status.

Setup - System Setup

Firmware Update

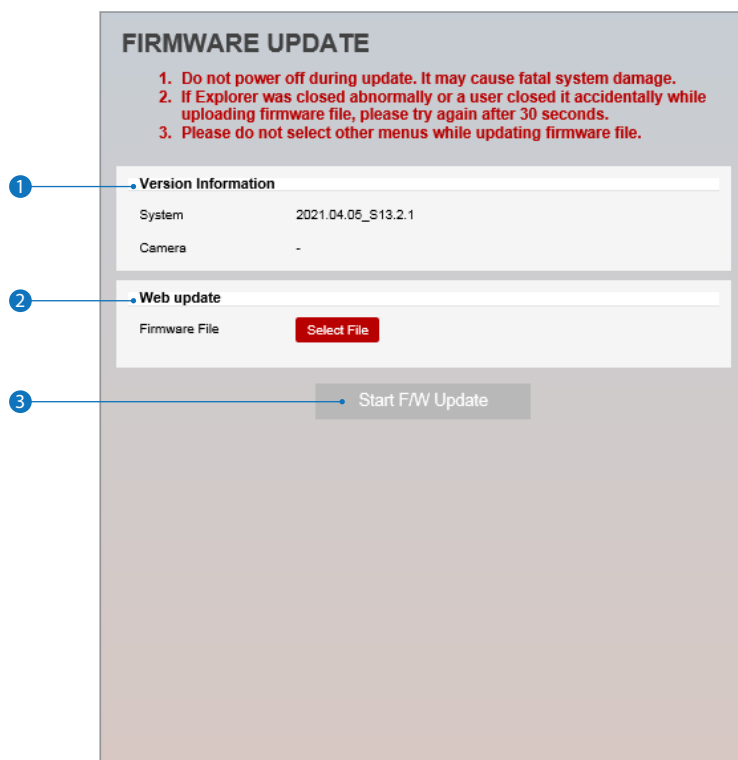

① **Version Information** - It shows the current Firmware Version in the system.

② **Web Update** - Select the Firmware file in your computer by clicking [Select file] button.

③ **Start F / W Update** - Click this button to start update. Progress of uploading will be displayed using Progress Bar.
If you assign the wrong file name, an error message will be shown.

⚠ **Warning:**

1. Do not turn off the power of camera during the Firmware update. Otherwise, the system can be stuck to be unstable.
If updating is finished, the system will be rebooted automatically.
2. Please make sure to check the 'Notice' shown on screen.
If firmware update is completed, the camera will reboot automatically and 'Setup window' will be closed.

Setup - System Setup

Date & Time Settings

The screenshot shows the 'DATE&TIME SETTINGS' interface. It is divided into three main sections: 'Time Zone Setup', 'Time Format', and 'Current Date & Time'. The 'Time Zone Setup' section has a dropdown menu for 'Time Zone' set to '(GMT 00) Greenwich Mean Time, Lisbon, London' and an 'Apply' button. The 'Time Format' section has a dropdown menu for 'Time Format' set to 'yy-mm-dd' and an 'Apply' button. The 'Current Date & Time' section shows the current date and time as '2005-01-02 00:54:10'. Below this is the 'New Camera Date & Time' section, which has three radio buttons: 'Synchronize with my computer' (selected), 'Setup manually', and 'Synchronize with time server (NTP)'. The 'Synchronize with my computer' section shows 'Date & Time' as '2021-04-13 18:04:40'. The 'Setup manually' section shows 'Date' as '2005 01 01' and 'Time' as '00 00 00'. The 'Synchronize with time server (NTP)' section shows 'NTP Server' as 'time-a.nist.gov'. There is an 'Apply' button at the bottom of the interface.

- 1 TimeZone Setup** - Choose TimeZone for camera. It will be activated after clicking 'Apply' button.
⚠️ Prior to setting below 'New Camera Date & Time', set correct Timezone first.
- 2 Time Format** - Select the time format yy-mm-dd or mm/dd/yy.
- 3 Current Date & Time** - Shows the current date and time setting in the Camera.
- 4 Synchronize with my computer** - Set the date / time using those of PC currently connected.
- 5 Setup manually** - Set the date / time by typing manually.
- 6 Synchronize with time sever Time Zone (NTP)** - Choose time server available to connect to current camera.
Date & Time will be updated automatically every hour when connected.
- 7** Click 'Apply' to make above setting effective.

Setup - System Setup

DST Settings

The screenshot shows the 'DST SETTINGS' interface. It is divided into two main sections: 'General Setting' and 'Date&Time Settings'. The 'General Setting' section has a radio button for 'Off' (selected) and a radio button for 'On'. The 'Date&Time Settings' section has two rows: 'Start Time' and 'End Time'. Each row has four dropdown menus: 'Jan', 'First', 'Sun', and '0', followed by 'o'clock'. A red 'Apply' button is located below the 'Date&Time Settings' section. Three numbered callouts (1, 2, 3) point to the 'General Setting' section, the 'Date&Time Settings' section, and the 'Apply' button, respectively.

Daylight Saving Time (DST) is the practice of setting the clocks forward one hour from standard time during the summer months, and back again in the fall, in order to make better use of natural daylight.

- 1 **General Setting** - DST function can be enable or disable.
- 2 **Date&Time Settings** - Set the Start time and end time that the DST apply.
- 3 Click 'Apply' to make above setting effective.

Setup - System Setup

Users Management

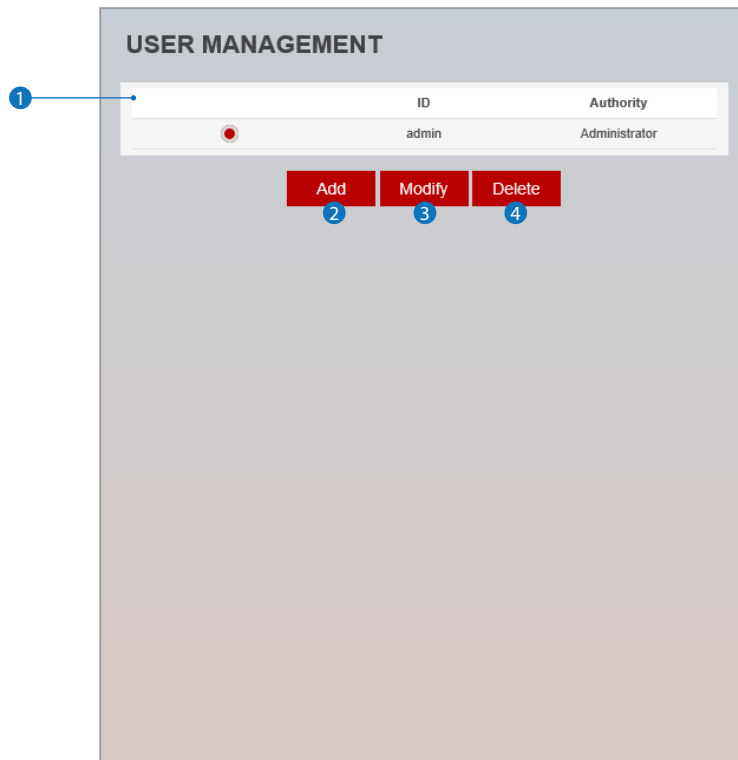

1 **Users** - List all the user accounts for authentication.

2 **Add** - Register a new user.

ID	Enter a new user ID except Admin since it exists.
Password	Enter the user Password. (Check the Password)
Verify	Enter the user Password again for verification.
User Authority	Select Operator or Viewer. Viewer : Only monitoring is allowed. Operator : Most of the functions are allowed except 'Setup'.

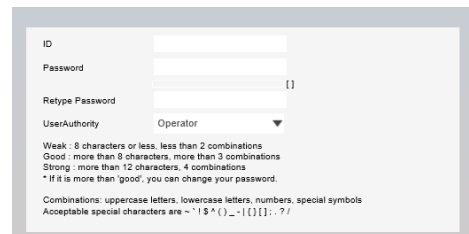

⊗ The ID is limited to 4~30 characters.

⊗ **[Password Rules]**

Weak : 8 characters or less, less than 2 combinations

Good : more than 8 characters, more than 3 combinations

strong : more than 12 characters, 4 combinations

⊗ If it is more than 'Good', you can change your password.

Combinations : uppercase letters, lowercase letters, numbers, special symbols.

Acceptable special characters are ~ ' ! & ^ () _ - | { } ; . ? /.

Click 'Apply' to make above setting effective.

⊗ Click 'Cancel' to return to the previous menu.

3 **Modify** - Modify the information of the user accounts registered. For admin account, only Password function can be modified.

4 **Delete** - Delete the selected user account. Admin account cannot be deleted.

Setup - System Setup

System Log

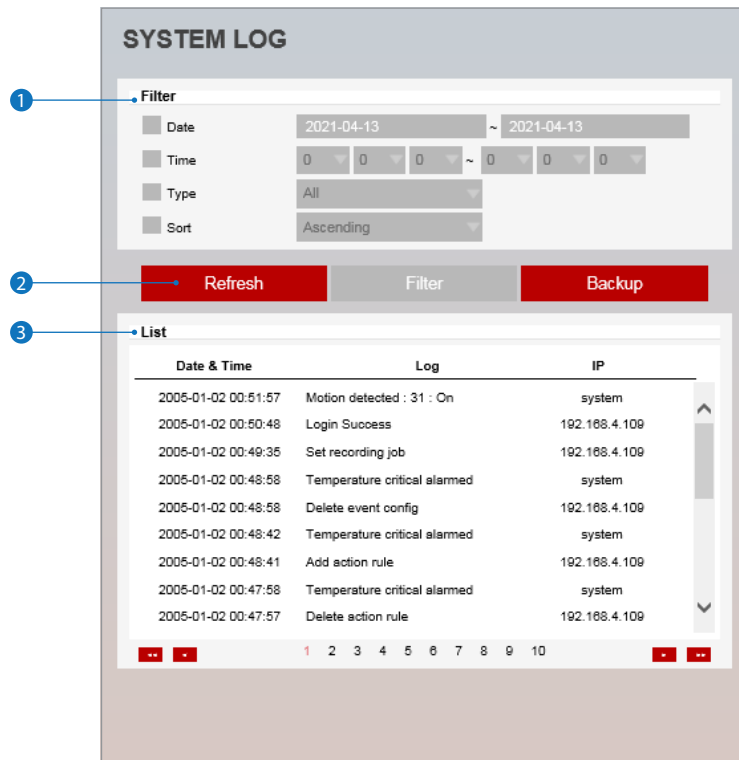

- 1 **Filter** - Select a date, time, sort or type of log to filter the log.
- 2 Click the 'Refresh' button to refresh the log list.
 - ☒ Click 'Filter' to view the filtered log.
 - ☒ Click 'Backup' to back up the filtered log.
- 3 **System Log List** - The filtered log is displayed.

Setup - System Setup

Language

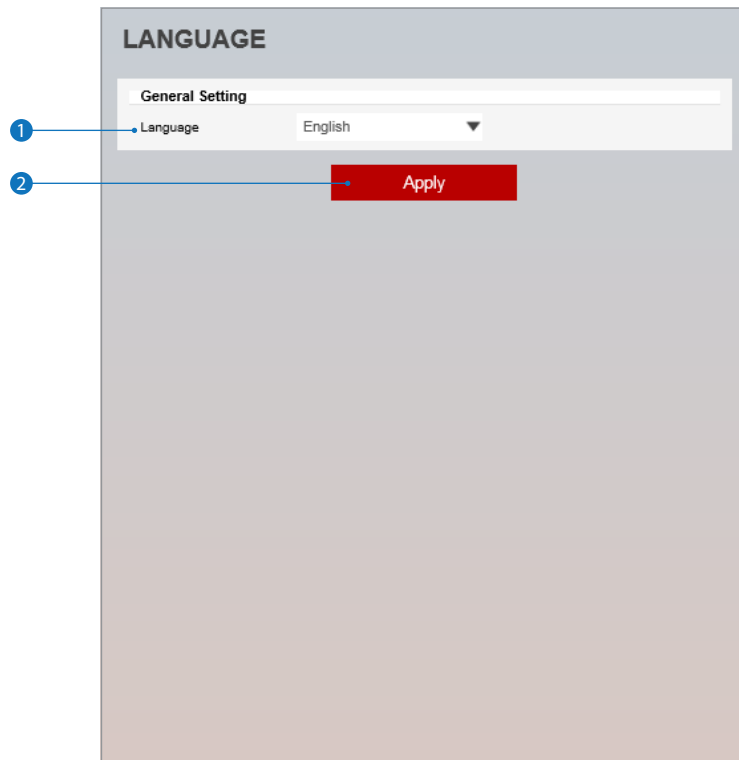

- 1 **Language** - Select the language you want from the list.
- 2 Click the 'Apply' to make above setting effective.

Setup - System Setup

Factory Reset

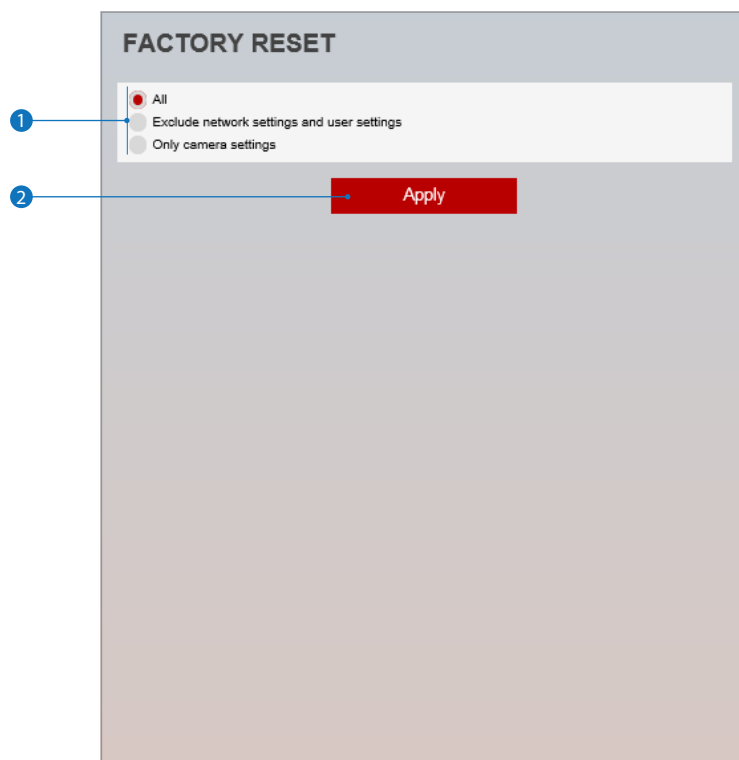

- 1 **Reset to the factory defaults** - Return the setup to the factory default.

All - Reset all Settings to the factory defaults.

Except Network Settings and User Settings - Except Network, User related settings , reset all others to the factory default.

Only Camera Settings - Reset only camera related settings to the factory defaults.

- 2 Click 'Apply' to make above setting effective.

Setup - System Setup

Restart

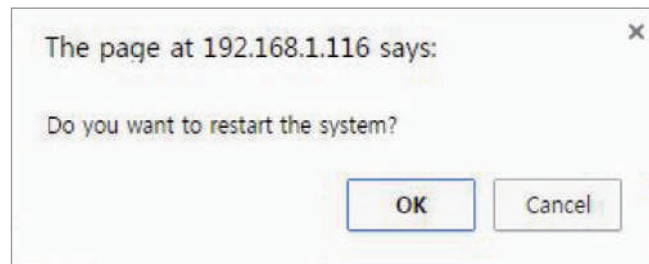

If you click the 'RESTART' menu, a message box will be shown to confirm. Click the 'OK' button to restart.

Setup - System Setup

System Open Source License

Open Source Name	Version	License
busybox	1.32.0	GPLv2
alsa-lib	1.1.6	GPLv2.1
libglib2	2.52.3	LGPLv2
libgnutls	3.6.2	LGPLv2.1
libjson-c	0.13.1-20180305	JSON License
libcurl	7.66.0	MIT/X derivate License
libffi	3.1	MIT License
libgcrypt	1.6.1	LGPLv2.1
libnl	3.4.0	LGPLv2.1
libogg	1.3.2	BSD-style License
libsamplerate	0.1.8	GPLv2
libselinux	2.7	Public domain
libsndfile	1.0.27	LGPLv2.1
libssh2	1.9.0	BSD
libtasn1	4.13	GPLv3

This menu will show you all the list of System Open Source License in the camera. Open Source Name / Version / License.

Appendix

A : Current TCP/IP Settings

i If your IP settings are obtained automatically, you could use the MS-DOS prompt (or Command Prompt) to determine your IP address. For information on how to do this, please read the FAQ.

1. Windows 7 Users

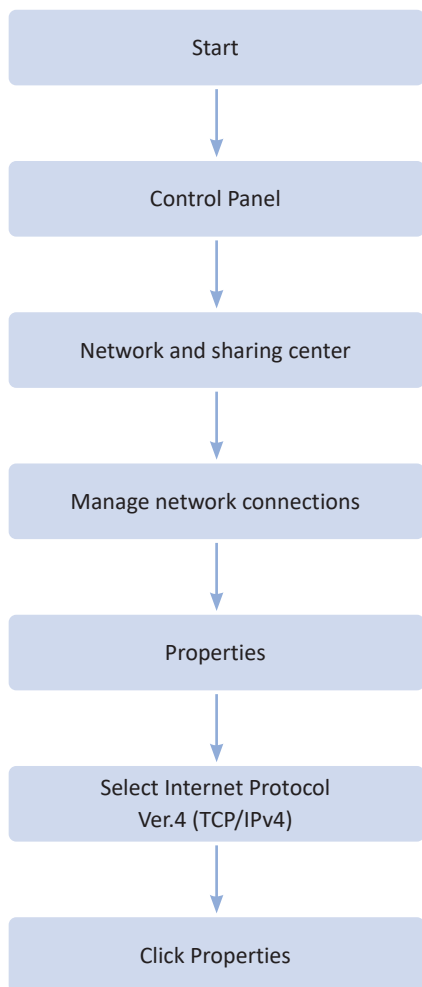

Under the 'General' tab of the TCP/IP Properties you will see your IP address information.

2. Windows 10 Users

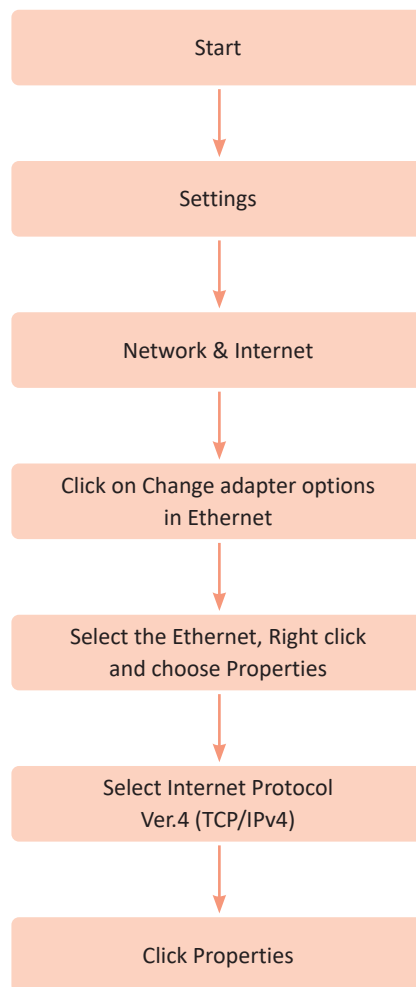

Under the 'General' tab of the TCP/IP Properties you will see your IP address information.

Appendix

B : Changing IP address and subnet mask

1. Windows 7 Users

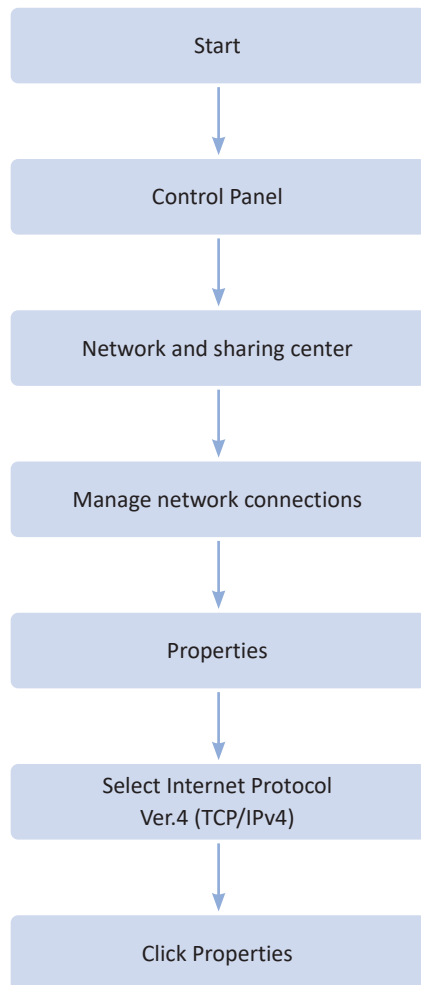

Select 'Use the following IP address'

2. Windows 10 Users

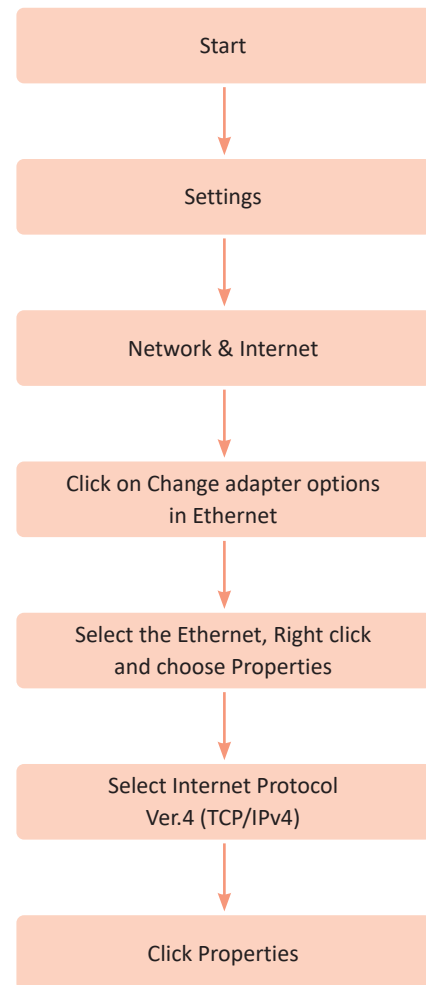

Select 'Use the following IP address'

Appendix

C : Port Forwarding

3. For Netgear RP614 routers:

- 1) Input http://192.168.0.1 in address bar of web browser.
http://192.168.0.1 is the default IP address.
- 2) If it asks ID and password, input admin as ID and password as password.
- 3) Click "Port Forwarding" in "Advanced".
- 4) Click "➊ Add Custom Service" button in Port Forwarding page.

Port Forwarding

Service Name: SERVICES Server IP Address: 192 . 168 . 0 . Add

#	Enable	Service Name	Start Port	End Port	Server IP Address
	<input type="checkbox"/>				

Add Custom Service Edit Service Delete Service

Apply Cancel

- 5) Input proper values in "Ports - Custom Services" page as below.

Ports - Custom Services

Enable

Service Name:

Starting Port: (1-65535)

Ending Port: (1-65535)

Server IP Address: 192 . 168 . 0 .

Add Cancel

Enable	Check it.
Service Name	Input IP Camera name.
Starting/ Ending Port	Input IP Camera Web Server port. Starting Port should be same as Ending Port.
Server IP Address	Input IP Camera IP Address.

- 6) Click "➋ Add" button.
- 7) With the same method as above, add Video Server Port.
- 8) Click "Apply" button to finish Port Forwarding.

Appendix

FAQ

1. My POWER light is not on?

Power is not being supplied to the unit. Please use the power supply shipped with the unit and verify that a power source is active from the attached power outlet used to connect the adapter. You can test this by plugging in any other electrical device and verify its operation. After using the power supply shipped with the product, checking the power source, and reinserting the power connector into the IP Camera, please call our Support Center. The power supply may be defective.

2. My ACTIVE light is not flashing?

Verify the power supply to the unit. Power off the unit and back on again, wait 1 minute, if the ACTIVE light still does not begin to flash, you will have to set the unit to its factory default (THIS WILL DELETE ANY CONFIGURATION AND SET THE UNIT TO THE FACTORY DEFAULTS). Power on the unit and insert the end of a paper clip into the small recessed opening on the back of the unit. Use the clip to press the button located within that opening.

3. My LINK light is not flashing or solid?

Verify the cable connection. 99% of the time the cable's connection to the unit is causing this problem. Try using a different network cable or crossover cable (for PC connection only). Try reinserting the cable, if this still doesn't solve the problem call our Support Center.

4. I can access the video server on my LAN, but not from the Internet.

Verify that your router (if applicable) has port forwarding properly configured. If accessing from our DDNS service, verify correct serial number. Firewall issues may prevent user access.

5. How do I open an MS-DOS or Command Prompt?

Start > (All) Programs > Accessories > Command Prompt

6. How do I find out my IP address information if my settings were automatically detected?

- 1) Open a Command Prompt
- 2) At the prompt type - "ipconfig / all" (without the quotes)
- 3) Near the end of the information supplied, should be your current IP address, subnet mask, default gateway and DNS servers

7. I can't connect!!

In the case of a connection failure.
Modem Reboot > Modem Reboot Finished > Router Reboot > Router Reboot Finished > IP Camera Reboot > IP Camera Reboot Finish > Verify DDNS and IP Camera connection, if applicable.

8. How do I "PING" an IP address?

- 1) Open an MS-DOS (or Command) prompt
- 2) At the prompt type - "ping xxx.xxx.xxx.xxx" (without the quotes and replace the "x" s with an IP address)
- 3) Press Enter

9. I'm accessing my video server remotely over the Internet and the video stream is choppy, is this normal?

Yes. The frames per second received remotely are determined by your bandwidth capabilities both at your site where the IP Camera is installed and your remote location. The lower of the two sites will determine how fast your video stream is received. It is recommended to have at least a 256Kb/sec upstream connection from the site where the IP Camera is installed. Lower speeds will operate properly, but provide poor remote performance. The Faster the Internet connection at both ends, the faster the video stream.

10. How do I enable or check VLC on my browser

Internet Explorer

Open Internet Explorer > Tools on the menu bar > Internet Options > Security Tab > Custom Level > Scroll down and verify that you are prompted or have enabled plug-ins to be downloaded and executed. > click OK > restart browser.

Chrome

Open Chrome > Chrome menu settings > Advanced settings > Individual information - content settings > Run automatically

11. How do I reset the unit to factory defaults?

Refer to the previous functions page and find the reset button. Power ON the unit and use a paper clip to push the reset button within that opening. You should then see the ACTIVE light turn off and after a few seconds the ACTIVE light will begin to flash, signifying a successful reboot. If the ACTIVE light does not turn off after depressing the reset button, please try holding the button in for a few seconds and releasing. YOU WILL LOSE ALL DATA THAT HAD BEEN ENTERED PREVIOUSLY AND THE IP CAMERA WILL BE SET TO ITS FACTORY RESETS.