

DS-2DE7A220MCG-EB 2 MP 20 × Network Speed Dome

ColorVu AcuSense

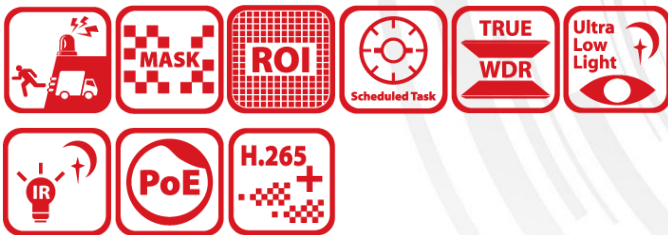

Hikvision DS-2DE7A220MCG-EB 2 MP 20 × Network Speed Dome adopts 1/1.8" progressive scan CMOS chip. With the 20 × optical zoom lens, the camera offers more details over expansive areas. This series of cameras can be widely used for wide ranges of high-definition, such as the rivers, roads, railways, airports, squares, parks, scenic spots, and venues, etc. Empowered by deep learning algorithms, Hikvision AcuSense technology brings human and vehicle targets classification alarms to front- and back-end devices. The system focuses on human and vehicle targets, vastly improving alarm efficiency and effectiveness.

- 24/7 colorful imaging
- High quality imaging with 2 MP resolution
- Audio visual alarm: The white flashing light and audible warning can be triggered by certain events
- 20 × optical zoom and 16 × digital zoom provide close up views over expansive areas
- Expansive night view with up to 150 m IR distance and 100 m white light
- Focuses on human and vehicle targets classification based on deep learning
- Face capture: Up to 5 faces captured at the same time

▪ DORI

The DORI (detect, observe, recognize, identify) distance gives the general idea of the camera ability to distinguish persons or objects within its field of view. It is calculated based on the camera sensor specification and the criteria given by EN 62676-4: 2015.

| DORI | Detect | Observe | Recognize | Identify |
|-----------------|----------------------|---------------------|--------------------|--------------------|
| Definition | 25 px/m | 63 px/m | 125 px/m | 250 px/m |
| Distance (Tele) | 1080.0 m (3543.3 ft) | 428.6 m (1406.2 ft) | 216.0 m (708.7 ft) | 108.0 m (354.3 ft) |

▪ Specification

| Camera | |
|------------------------|---|
| Max. Resolution | 1920 × 1080 |
| Image Sensor | 1/1.8" Progressive Scan CMOS |
| Min. Illumination | Color: 0.0005Lux @ (F1.2, AGC ON), B/W: 0.0001Lux @ (F1.2, AGC ON), 0 lux with light |
| Shutter Speed | 1/1 s to 1/30000 s |
| Slow Shutter | Yes |
| Day & Night | IR cut filter |
| Zoom | 20 × optical, 16 × digital |
| Lens | |
| Focal Length | 6.7 mm to 134 mm |
| Zoom Speed | Approx. 7 s |
| FOV | Horizontal field of view: 53° to 4.9° (wide-tele), Vertical field of view: 31.3° to 2.7° (wide-tele), Diagonal field of view: 59.6° to 5.6° (wide-tele) |
| Aperture | Max. F1.2 |
| Focus | Auto, semi-auto, manual |
| Illuminator | |
| Supplement Light Type | Hybrid (IR and White Light) |
| Supplement Light Range | White light: up to 100 m IR: up to 150 m |
| PTZ | |
| Movement Range (Pan) | 360° |
| Movement Range (Tilt) | -15° to 90° (auto flip) |
| Pan Speed | Pan speed: configurable from 0.1° to 160°/s; preset speed: 240°/s |
| Tilt Speed | Tilt speed: configurable from 0.1° to 120°/s, preset speed 200°/s |
| Proportional Pan | Yes |
| Presets | 300 |
| Patrol Scan | 8 patrols, up to 32 presets for each patrol |
| Pattern Scan | 4 pattern scans |
| Power-off Memory | Yes |
| Park Action | Preset, patrol scan, pattern scan, auto scan, tilt scan, random scan, frame scan, panorama scan |
| 3D Positioning | Yes |
| PTZ Status Display | Yes |
| Preset Freezing | Yes |

| | |
|-----------------------------|---|
| Scheduled Task | Preset, pattern scan, patrol scan, auto scan, tilt scan, random scan, frame scan, panorama scan, dome reboot, dome adjust, aux output |
| Video | |
| Main Stream | 50 Hz: 25 fps (1920 × 1080, 1280 × 960, 1280 × 720); 60 Hz: 24 fps (1920 × 1080, 1280 × 960, 1280 × 720) |
| Sub-Stream | 50 Hz: 25 fps (704 × 576, 640 × 480, 352 × 288); 60 Hz: 24 fps (704 × 480, 640 × 480, 352 × 240) |
| Third Stream | 50 Hz: 25 fps (1920 × 1080, 1280 × 960, 1280 × 720, 704 × 576, 640 × 480, 352 × 288); 60 Hz: 24 fps (1920 × 1080, 1280 × 960, 1280 × 720, 704 × 480, 640 × 480, 352 × 240) |
| Video Compression | Main stream: H.265+/H.265/H.264+/H.264 Sub-stream: H.265/H.264/MJPEG Third stream: H.265/H.264/MJPEG |
| Video Bit Rate | 32 kbps to 16384 kbps |
| H.264 Type | Baseline Profile/Main Profile/High Profile |
| H.265 Type | Main Profile |
| Scalable Video Coding (SVC) | H.264 and H.265 encoding |
| Region of Interest (ROI) | 8 fixed regions for each stream |
| Audio | |
| Audio Compression | G.711alaw, G.711ulaw, G.722.1, G.726, MP2L2, PCM, AAC-LC |
| Audio Bit Rate | 64 Kbps (G.711)/16 Kbps (G.722.1)/16 Kbps (G.726)/32-192 Kbps (MP2L2)/16 to 64 Kbps (AAC-LC) |
| Audio Sampling Rate | 8 kHz/16 kHz/32 kHz/48 kHz |
| Environment Noise Filtering | Yes |
| Network | |
| Network Storage | NAS (NFS, SMB/CIFS), auto network replenishment (ANR) |
| Protocols | IPv4/IPv6, HTTP, HTTPS, 802.1x, QoS, FTP, SMTP, UPnP, SNMP, DNS, DDNS, NTP, RTSP, RTCP, RTP, TCP/IP, UDP, IGMP, ICMP, DHCP, PPPoE, Bonjour, WebSocket, WebSockets |
| API | Open Network Video Interface (Version 19.12, Profile S, Profile G, Profile T), ISAPI, SDK, ISUP |
| Simultaneous Live View | Up to 20 channels |
| User/Host | Up to 32 users, 3 user levels: administrator, operator, and user |
| Security | Password protection, complicated password, HTTPS encryption, 802.1X authentication (EAP-TLS, EAP-LEAP, EAP-MD5), watermark, IP address filter, basic and digest authentication for HTTP/HTTPS, RTP/RTSP over HTTPS, control timeout settings, security audit log, TLS 1.2, TLS 1.3, host authentication (MAC address) |
| Client | iVMS-4200, HikCentral Pro, Hik-Connect |
| Web Browser | IE11, Chrome 57+, Firefox 52+, Safari 11+ |
| Image | |
| Day/Night Switch | Day, Night, Auto, Schedule |
| Image Enhancement | BLC, HLC, 3D DNR |
| Wide Dynamic Range (WDR) | 120 dB |
| Defog | Digital defog |
| Image Stabilization | EIS |
| Regional Exposure | Yes |
| Regional Focus | Yes |

| | |
|-------------------------------|---|
| Image Settings | Saturation, brightness, contrast, sharpness, gain, and white balance adjustable by client software or web browser |
| Privacy Mask | 24 programmable polygon privacy masks, mask color or mosaic configurable |
| SNR | > 52 dB |
| Interface | |
| Ethernet Interface | 1 RJ45 10M/100M self-adaptive Ethernet port |
| On-board Storage | Built-in memory card slot, support microSD/SDHC/SDXC card, up to 256 GB |
| Alarm | 2 inputs, 1 output |
| Audio | 1 input (line in), max. input amplitude: 2-2.4 vpp, input impedance: 1 kΩ ± 10%; 1 output (line out), line level, output impedance: 600 Ω |
| Reset | Yes |
| Built-in Speaker | 1 built-in speaker with effective distance reaching max. 30 meters |
| Event | |
| Basic Event | Motion detection, video tampering alarm, exception, alarm input and output |
| Smart Event | Line crossing detection, intrusion detection, region entrance detection, region exiting detection, unattended baggage detection, object removal detection, audio exception detection |
| Smart Tracking | Manual tracking, auto-tracking |
| Alarm Linkage | Upload to FTP/NAS/memory card, notify surveillance center, send email, trigger alarm output, trigger recording, audible warning, white light flashing, and PTZ actions (such as preset, patrol scan, pattern scan) |
| Deep Learning Function | |
| Face Capture | Detects up to 5 faces simultaneously. Supports detecting, capturing, grading, selecting of face in motion, and output the best face picture of the face |
| Perimeter Protection | Line crossing, intrusion, region entrance, region exiting Support alarm triggering by specified target types (human and vehicle) |
| General | |
| Power | 24 VAC, max. 42 W (including max. 12 W for IR and max. 2 W for heater); Hi-PoE |
| Operating Condition | -30 °C to 65 °C (-22 °F to 149 °F). Humidity 90% or less (non-condensing) |
| Demist | Yes |
| Material | ADC12 |
| Dimension | ∅ 220 mm × 357.3 mm (∅8.66" × 14.07") |
| Weight | Approx. 5.5 kg (12.13 lb.) |
| Approval | |
| Protection | IP66 (IEC 60529-2013), IK10 (excluding glass window), TVS 6000V lightning protection, surge protection and voltage transient protection |
| EMC | FCC SDoC (47 CFR Part 15, Subpart B); CE-EMC (EN 55032: 2015, EN 61000-3-2: 2019, EN 61000-3-3: 2013, EN 50130-4: 2011 +A1: 2014); RCM (AS/NZS CISPR 32: 2015); IC VoC (ICES-003: Issue 6, 2019); KC (KN 32: 2015, KN 35: 2015) |

| | |
|-------------|---|
| Safety | UL (UL 62368-1); CB (IEC 60950-1:2005 + Am 1:2009 + Am 2:2013, IEC 62368-1:2014); CE-LVD (EN 62368-1:2014+A11:2017); BIS (IS 13252(Part 1):2010+A1:2013+A2:2015); LOA (SANS IEC60950-1) |
| Environment | CE-RoHS (2011/65/EU); WEEE (2012/19/EU); Reach (Regulation (EC) No 1907/2006) |

▪ **Available Model**

DS-2DE7A220MCG-EB

▪ **Dimension**

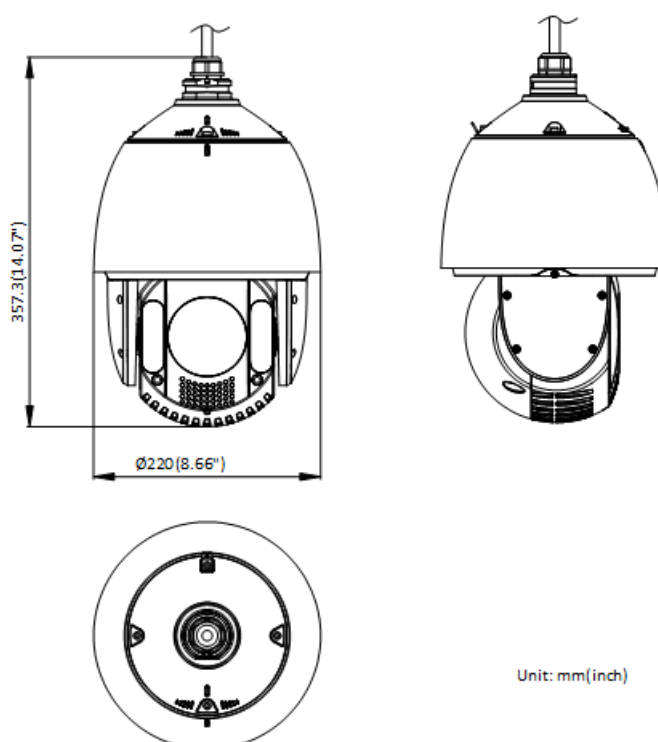







▪ **Accessory**

▪ **Included**



▪ **Optional**

| | | | | |
|---|---|--|--|--|
| <p>JBPW-L Wall Mount</p> | <p>SNB-PV Pendant Mount</p> | <p>CPM-S Pendant Mount</p> | <p>CPM-L Pendant Mount</p> | <p>CPM-S Ceiling Mount</p> |
|  |  |  |  |  |
| <p>CMPL Wall Mount with Junction Box</p> | <p>PMPL Pole Mount</p> | <p>RPM Parapet Wall Mount</p> | <p>CPMPE</p> | <p>PMP Vertical Pole Mount</p> |
|  |  |  |  |  |
| <p>DS-1100KI(B) Network Keyboard</p> | <p>JBPW Wall Mount</p> | | | |
|  |  | | | |

Headquarters

No.555 Qianmo Road, Binjiang District,
Hangzhou 310051, China
T +86-571-8807-5998
www.hikvision.com



Follow us on social media to get the latest product and solution information.

