

## EKT-KxxT2x Series

### 2 MP Value Express TurboHD Kits

#### Cameras

- 2 MP High Performance CMOS
- Up to 1920 x 1080 Resolution
- 2.8 mm Fixed Lens
- EXIR 2.0 with up to 65 ft (20 m) IR Range
- Smart IR
- Digital WDR, BLC
- IP66 Protection



**EKT-K41T24:** (4) 2 MP TurboHD Cameras • (1) 4-Channel DVR w/1 TB HDD

#### DVR

- Up to 4 MP Resolution Recording
- Up to 6- or 12-ch 6 MP IP Camera Input
- H.265+/H.265/H.264+/H.264
- 4- or 8-ch Synchronous Playback
- 1 SATA Interface (up to 10 TB Capacity per HDD)



**EKT-K82T26:** (6) 2 MP TurboHD Cameras • (1) 8-Channel DVR w/2 TB HDD

Hikvision EKT-KxxT2x Series 2 MP Value Express TurboHD Kits are cost-effective solutions for value-oriented users.

Each kit is supplied with four or six TurboHD cameras with 2 MP image sensors and a 4-, or 8-channel DVR in the same box.

Kit DVRs are pre-installed with a 1 or 2 TB HDD.

#### Available models:

##### EKT-K41T24

(1) ERT-K2041 DVR (1 TB HDD) + (4) TurboHD ECT-T12F2 Cameras

##### EKT-K82T26

(1) ERT-K2082 DVR (2 TB HDD) + (6) TurboHD ECT-T12F2 Cameras



# Specifications

| EKT-K41T24                  |  | EKT-K82T26   |
|-----------------------------|--|--|
| <b>CAMERA</b>               |  |  |
| Camera Model                | ECT-T12F2  |  |
| Number of Cameras           | 4  | 6  |
| Image Sensor                | 2 MP CMOS image sensor   |  |
| Signal System               | NTSC   |  |
| Effective Pixels            | 1920 (H) × 1080 (V)  |  |
| Minimum Illumination        | 0.01 lux @ (f/1.2, AGC on), 0 lux with IR  |  |
| Shutter Speed               | 1/25 (1/30) s to 1/50,000 s  |  |
| Lens                        | 2.8 mm fixed lens  |  |
| Horizontal Field of View    | 103°   |  |
| Lens Mount                  | M12  |  |
| Day/Night                   | IR cut filter  |  |
| Angle Adjustment            | Pan: 0° to 360°, tilt: 0° to 75°, rotation: 0° to 360°   |  |
| Synchronization             | Internal synchronization   |  |
| Video Frame Rate            | 1080p @ 30 fps   |  |
| <b>Menu</b>                 |  |  |
| AGC                         | High/medium/low/off  |  |
| D/N Mode                    | Auto/color/BW (black and white)  |  |
| BLC                         | Supported  |  |
| DWDR                        | Supported  |  |
| Language                    | English  |  |
| Functions                   | Brightness, sharpness, DNR, mirror, smart IR   |  |
| <b>Interface</b>            |  |  |
| Video Output                | 1 HD analog output   |  |
| Switch Button               | TVI/AHD/CVI/CVBS   |  |
| <b>General</b>              |  |  |
| Operating Conditions        | -40° to 140° F (-40° to 60° C), humidity: 90% or less (non-condensing)   |  |
| Power Supply                | 12 VDC ±25%  |  |
| Power Consumption           | Maximum 4 W  |  |
| Protection Level            | IP66   |  |
| Material                    | Metal  |  |
| IR Range                    | Up to 650 ft (20 m)  |  |
| Dimensions                  | Ø3.38" x 2.74" (Ø82.6 mm x 69.66 mm)   |  |
| Weight                      | ~0.51 lbs (~230 g)   |  |
| <b>DVR</b>                  |  |  |
| DVR Model                   | ERT-K2041  | ERT-K2082  |
| <b>Video/Audio Input</b>    |  |  |
| Video Compression           | H.265 Pro+/H.265 Pro/H.265/H.264+/H.264  |  |
| Analog Video Input          | 4-ch   | 8-ch   |
| TurboHD Input               | 4 MP, 3 MP: 1080p25, 1080p30, 720p25, 720p30, 720p50, 720p60   |  |
| AHD Input                   | 4 MP, 1080p25, 1080p30, 720p25, 720p30   |  |
| HD-CVI Input                | 4 MP, 1080p25, 1080p30, 720p25, 720p30   |  |
| CVBS Input                  | PAL/NTSC   |  |
| IP Video Input (Up to 6 MP) | 2 + 1 for each analog channel not used, up to 6 maximum  | 4 + 1 for each analog channel not used, up to 12 maximum   |
| Audio Compression           | 6.711u   |  |
| Audio Input/Two-Way Audio   | 1-ch, RCA (2.0 Vp-p, 1K Ω)   |  |
| <b>Video/Audio Output</b>   |  |  |
| HDMI/VGA Output             | 1-ch, 1920 × 1080/60 Hz, 1280 × 1024/60 Hz, 1280 × 720/60 Hz, 1024 × 768/60 Hz   |  |
| Encoding Resolution         | When 1080p Lite mode not enabled: 4 MP lite/1080p/720p/VGA/WD1/4CIF/CIF;<br>When 1080p Lite mode enabled: 1080p lite/720p/VGA/WD1/4CIF/CIF |  |
| Main Stream Frame Rate      | 1080p Lite Mode Not Enabled  | 4 MP stream access: 4 MP lite @ 15 fps; 1080p lite/720p/WD1/4CIF/VGA/CIF @ 25 fps (P)/30 fps (N)<br>1080p stream access: 1080p/720p @ 15 fps<br>720p stream access: 720p   |
|                             | 1080p Lite Mode Enabled  | 4 MP stream access: 4 MP lite @ 15 fps; 1080p lite/720p lite/WD1/4CIF/VGA/CIF @ 25 fps (P)/30 fps (N)<br>1080p stream access: 1080p lite/720p lite/WD1/4CIF/VGA/CIF @ 25 fps (P)/30 fps (N)<br>720p stream access: 720p/WD1/4CIF/VGA/CIF @ 25 fps (P)/30 fps (N) |
| Sub-Stream Frame Rate       | WD1/4CIF/2CIF @ 12 fps; CIF/QVGA/QCIF @ 25 fps (P)/30 fps (N)  |  |
| Video Bit Rate              | 32 Kbps to 6 Mbps  |  |
| Audio Output                | 1-ch, RCA (linear, 1K Ω)   |  |
| Audio Bit Rate              | 64 Kbps  |  |
| Dual Stream                 | Supported  |  |
| Stream Type                 | Video, Video & Audio   |  |
| Synchronous Playback        | 4-ch   |  |
| <b>Network</b>              |  |  |
| Remote Connections          | 32   | 64   |
| Network Protocols           | TCP/IP, PPPoE, DHCP, Hik-Connect, DNS, DDNS, NTP, SADP, NFS, iSCSI, UPnP™, HTTPS, ONVIF  |  |
| <b>Hard Disk</b>            |  |  |
| SATA                        | 1 SATA interface   |  |
| Capacity                    | Up to 10 TB capacity for each disk   |  |
| Hard Drive Size             | 1 TB   | 2 TB   |
| <b>External Interface</b>   |  |  |
| Network Interface           | 1, RJ-45 10M/100M self-adaptive Ethernet interface   |  |
| USB Interface               | Rear panel: 2 × USB 2.0  |  |
| <b>General</b>              |  |  |
| Power Supply                | 12 VDC   |  |
| Consumption (w/o HDD)       | ≤8 W   | ≤12 W  |
| Working Temperature         | +14° to +131° F (-10° to +55° C)   |  |
| Working Humidity            | 10% to 90% non-condensing  |  |
| Dimensions                  | 10.2" × 8.7" × 1.8" (260 mm × 222 mm × 45 mm)  |  |
| Weight (w/o HDD)            | ≤2.2 lb (≤1 kg)  |  |

## Dimensions

ECI-T12F2 Camera

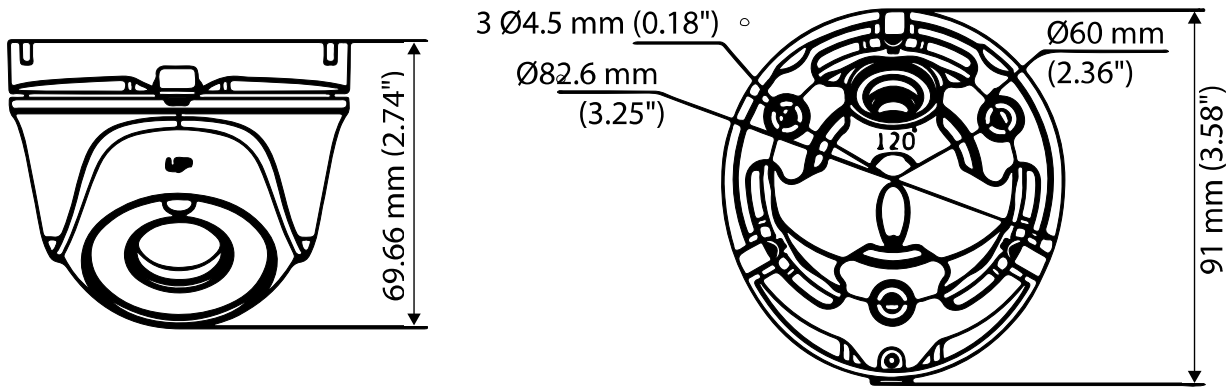

Unit: mm (inch)

## Interface

ERT-K2041 DVR Rear Panel

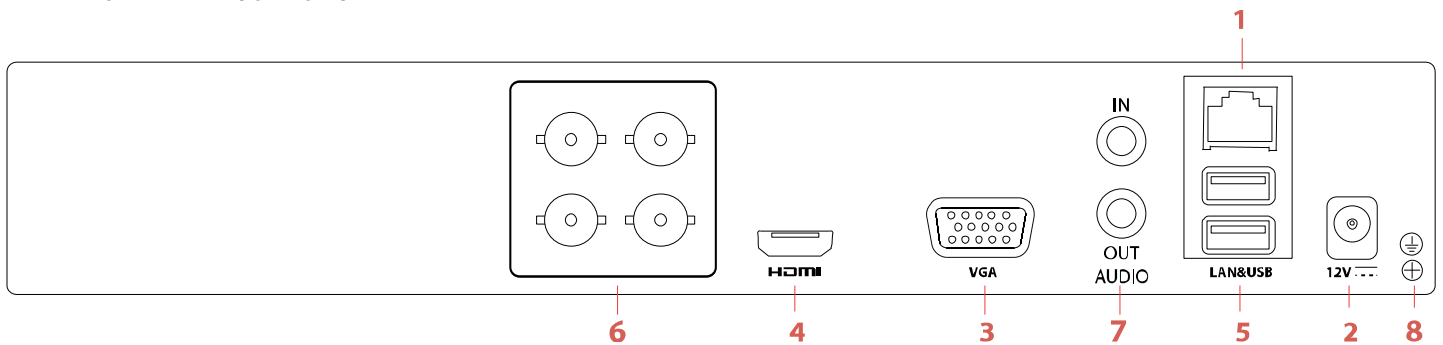



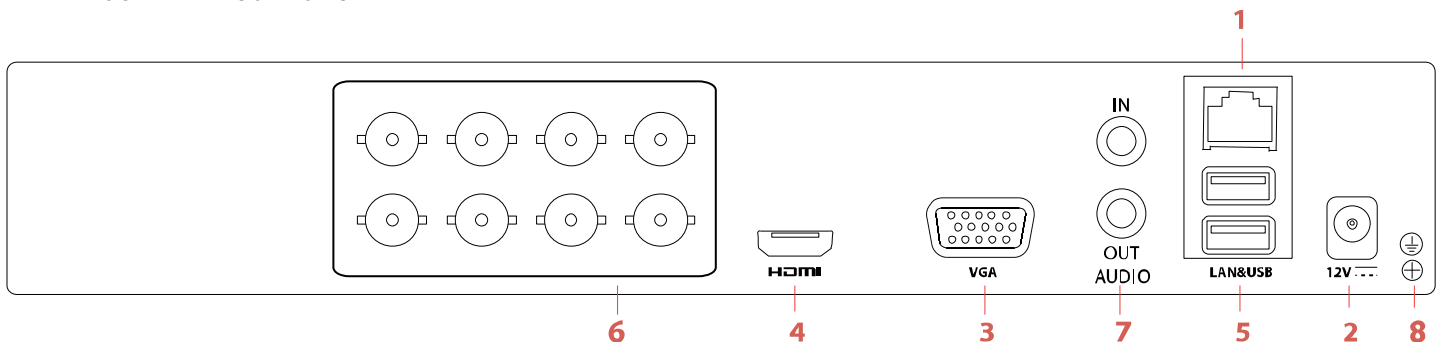

ERT-K2082 DVR Rear Panel



| No. | Item                 | Description   |
|-----|----------------------|---|
| 1   | LAN                  | Network connector   |
| 2   | Power Supply         | Input: 100 to 240 VAC, Output: 12 VDC                                 |
| 3   | VGA                  | DB-15 connector for VGA output. Displays local video output and menu. |
| 4   | HDMI                 | HDMI video output connector   |
| 5   | USB Interface        | Universal Serial Bus port for additional devices                      |
| 6   | Analog Camera Inputs | BNC connectors for analog input                                       |
| 7   | Audio In/Out         | RCA connectors  |
| 8   | Ground               | Grounding screw   |

## Accessories (Not Included)

---

|   |   |   |   |  |
|---|---|---|---|--|
|  |  |  |  |  |
| <b>PC110T</b><br>110 mm<br>Pendant Cap  | <b>WMS</b><br>Short Wall<br>Mount w/<br>Junction Box                              | <b>PM</b><br>Pole Mount<br>Adapter  | <b>CM</b><br>Corner Mount<br>Adapter  | <b>CBXS</b><br>Conduit Base  |

## Box Contents (Subject to Change without Notice)

---

Quick Start Guide (Camera)  
Quick Start Guide (DVR)  
Screws  
Mounting Template  
Power Pigtail with Power Leads  
Mouse  
Power Supply